

**MODEL VC-7524/VC-7504/VC-7502**

**DIGITAL OSCILLOSCOPE**

**OPERATION MANUAL**

**READ THE IMPORTANT SAFETY-RELATED MARKINGS CAREFULLY BEFORE USE.**

**NOTE THE FOLLOWING SAFETY RELATED MARKINGS AND SYMBOLS.**

(1) Terms

- DANGER:** Risk of hazard which causes serious injury to persons.
- WARNING:** Risk of hazard which may cause serious injury to persons.
- CAUTION:** Risk of hazard which may cause injury to persons, fire hazard or serious damage to the oscilloscope.
  
- IMPORTANT:** Important note not related to risk of hazard directly
- NOTICE:** Important note not related to risk of hazard, but observed for installation, operation, maintenance, etc.





(2) Symbols

-  **DANGER** : DANGER
-  **WARNING** : WARNING
-  **CAUTION** : CAUTION
-  : PROTECTIVE GROUND TERMINAL

**Note:** The model and serial numbers of your OSCILLOSCOPE are important for you to keep for your convenience and protection. These numbers appear on the nameplate located on the rear of the oscilloscope. Please record these numbers in the spaces provided below, and retain this manual for future reference.

**Model No** \_\_\_\_\_ **Serial No.** \_\_\_\_\_

**SAFETY CONTENTS**

READ THE IMPORTANT SAFETY-RELATED MARKINGS CAREFULLY BEFORE USE .....	A
 SAFETY INSTRUCTIONS .....	B
 SAFEGUARDS .....	C
 SAFETY OPERATIONS .....	E
 WARNING MARKINGS .....	F
INSTRUCTIONS BEFORE USE .....	G
SAFETY CAUTION .....	H
NOTES TO USERS .....	I

**IMPORTANT  
SAFETY INSTRUCTIONS**



CAUTION

RISK OF ELECTRIC SHOCK  
DO NOT OPEN



**CAUTION:** TO REDUCE THE RISK OF ELECTRIC SHOCK, DO NOT REMOVE COVER. NO USER - SERVICEABLE PARTS INSIDE. REFER SERVICING TO QUALIFIED SERVICE PERSONNEL.

**Explanation of Graphical Symbols**



The lightning flash with arrowhead symbol, within an equilateral triangle, is intended to alert the user to the presence of uninsulated "dangerous voltage" within the oscilloscope's enclosure; that may be of sufficient magnitude to constitute a risk of electric shock to persons.



The exclamation point within an equilateral triangle is intended to alert the user to the presence of important operating and maintenance (servicing) instructions in the literature accompanying the oscilloscope.

**WARNING :** TO REDUCE THE RISK OF FIRE OR ELECTRIC SHOCK, DO NOT EXPOSE THIS OSCILLOSCOPE TO RAIN OR MOISTURE.

**NOTE FOR USERS IN THE UNITED KINGDOM:**

**IMPORTANT:**

The wires of the mains lead are coloured in accordance with the following code:

Green-and-yellow:	EARTH
Blue:	NEUTRAL
Brown:	LIVE

As the colours of the wires in the mains lead of this oscilloscope may not correspond with the coloured markings identifying the terminals in your plug, proceed as follows:

- The wire which is coloured green and yellow must be connected to the terminal in the plug which is marked by the letter E or by the safety earth symbol  $\perp$  or coloured green or green and yellow.
- The wire which is coloured blue must be connected to the terminal which is marked with the letter N or coloured black.
- The wire which is coloured brown must be connected to the terminal which is marked with the letter L or coloured red.

**WARNING:** The apparatus must be earthed.

## IMPORTANT

---

## SAFEGUARDS

---

### Read Instructions

All the safety and operating instructions must be read before the oscilloscope is operated.

### Retain Instructions

The safety and operating instructions must be retained for future reference.

### Heed Warnings

All warnings on the oscilloscope and in the operating instructions must be adhered to.

### Follow Instructions

All operating and use instructions must be followed.

### Cleaning

Unplug this oscilloscope from the power source before cleaning. Do not use liquid cleaners or aerosol cleaners. Use a damp cloth for cleaning.

### ⚠ CAUTION

#### Attachments

Do not use attachments not recommended by the oscilloscope manufacturer as they may cause hazards.

### ⚠ WARNING

#### Water and Moisture

Do not use this oscilloscope near water - for example, near a bath tub, wash bowl, kitchen sink, or laundry tub, in a wet basement, or near a swimming pool, and the like.

### ⚠ WARNING

#### Accessories

Do not place this oscilloscope on an unstable cart, stand, tripod, bracket, or table. **The oscilloscope may fall, causing serious injury to a person, and serious damage to the oscilloscope.** Use only with a cart, stand, tripod, bracket, or table recommended by the manufacturer, or sold with the oscilloscope. Any mounting of the oscilloscope should follow the manufacturer's instructions, and must use a mounting accessory recommended by the manufacturer.

### ⚠ CAUTION

#### Ventilation

Slots and openings in the cabinet are provided for ventilation and to ensure reliable operation of the oscilloscope and to protect it from over-heating, and these openings must not be blocked or covered.

The openings must never be blocked by placing the oscilloscope on a bed, sofa, rug, or similar surface. This oscilloscope should never be placed in a built-in installation such as a bookcase or rack unless proper ventilation is provided or the manufacturer's instructions have been adhered to.

**⚠ WARNING**

**Power Sources**

This oscilloscope should be operated only from the type of power source indicated on the marking label. If you are not sure of the type of power supply to your home, consult your oscilloscope dealer or local power company. The oscilloscopes are not intended to operate from battery power.

**⚠ WARNING**

**Power-Cord Protection**

Power-supply cords should be routed so that they are not likely to be walked on or pinched by items placed upon or against them, paying particular attention to cords at plugs, convenience receptacles, and the point where they exit from the oscilloscope.

**Lightning**

For added protection for this oscilloscope during a lightning storm, or when it is left unattended and unused for long periods of time, unplug it from the power source. This will prevent damage to the oscilloscope due to lightning and power-line surges.

**⚠ WARNING**

**Overloading**

Do not overload power source and extension cords as this can result in a risk of fire or electric shock.

**⚠ WARNING**

**Object and Liquid Entry**

Never push objects of any kind into this oscilloscope through openings as they may touch dangerous voltage points or short out parts that could result in a fire or electric shock. Never spill liquid of any kind on the oscilloscope.

**⚠ WARNING**

**Flammable and Explosive Substance**

Avoid using this oscilloscope where there are gases, and also where there are flammable and explosive substances in the immediate vicinity.

**Heavy Shock or Vibration**

When carrying this oscilloscope around, do not subject the oscilloscope to heavy shock or vibration.

**⚠ WARNING**

**Servicing**

Do not attempt to service this oscilloscope yourself as opening or removing covers may expose you to dangerous voltage or other hazards. Refer all servicing to qualified service personnel.

**⚠ WARNING**

**Damage Requiring Service**

Unplug this oscilloscope from the power source and refer servicing to qualified service personnel under the following conditions:

- a. When the power-supply cord or plug is damaged.
- b. If liquid has been spilled, or objects have fallen into the oscilloscope.
- c. If the oscilloscope has been exposed to rain or water.

- d. If the oscilloscope does not operate normally by following the operating instructions. Adjust only those controls that are covered by the operating instructions as an improper adjustment of other controls may result in damage and will often require extensive work by a qualified technician to restore the oscilloscope to its normal operation.

**⚠ WARNING**

**Replacement Parts**

When replacement parts are required, be sure the service technician has used replacement parts specified by the manufacturer or have the same characteristics as the original part. **Unauthorized substitutions may result in fire, electric shock or other hazards.**

**Safety Check**

Upon completion of any service or repairs to this oscilloscope, ask the service technician to perform safety checks to determine that the oscilloscope is in proper operating condition.

**IMPORTANT**

---

**SAFETY OPERATIONS**

---

Before operating the oscilloscope, be sure to check the following items.

**⚠ DANGER**      **⚡ PROTECTIVE GROUND TERMINAL**

**Connection with the AC power source**

**Be sure to plug the power cord into an AC outlet provided with a protective ground terminal to avoid the risk of electric shock.**

The oscilloscope is provided with the protective ground terminal and the three line power cord and plug to be connected to the AC power source.

The lead of the protective ground terminal is connected to the metallic part of the oscilloscope.

**⚠ WARNING**

**Replacement of fuse**

**Do not try to use any fuse other than the specified ones.** Otherwise, further damage may occur and this could be dangerous.

Use only specified fuses. The oscilloscope is protected by the fuse on the primary side of the power supply. When this fuse blows, contact your nearest Hitachi Denshi representative.

**⚠ DANGER**

**Operation in gas**

**Do not use the oscilloscope in flammable gas or vapor to avoid possible explosion.**

**POWER switch**

Before plugging in the AC cord, be sure to check that the POWER switch is set to OFF for protection of the oscilloscope.

**⚠ WARNING**

**Removal of the chassis cover**

Do not remove the chassis cover to avoid the risk of electric shock since a high voltage presents inside the oscilloscope.

**⚠ WARNING**

**Line voltage**

Use the oscilloscope within the specified line voltage. ( 90 to 132V AC or 180 to 250V AC )

If an abnormal operation occurs, turn off the power for a short time and check the line voltage. If the line voltage is the specified voltage, turn on the power back.

The oscilloscope operates normally with the 90 to 132V or 180 to 250V line voltage. If the line voltage is out of the above range ( especially low voltage ), the normal operation may not be restored after the correct line voltage is applied.

**IMPORTANT**

**WARNING MARKING**



The caution label is printed on the rear of the oscilloscope. (Refer to Fig. A.)

The caution label is shown in Fig. B.

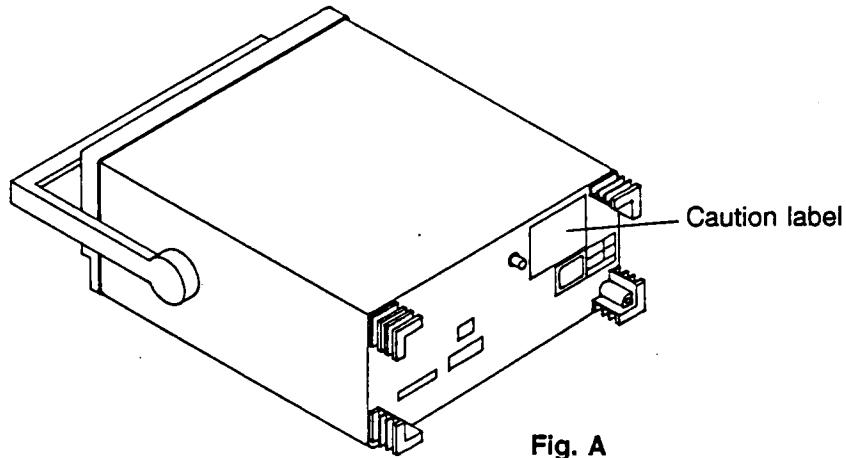
Observe the caution to assure proper handling

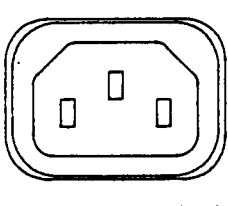

**Fig. A**

 <b>CAUTION</b>   TO AVOID ELECTRIC SHOCK THE POWER CORD PROTECTIVE GROUNDING CONDUCTOR MUST BE CONNECTED TO GROUND.  DO NOT REMOVE COVERS. REFER SERVICING TO QUALIFIED PERSONNEL.  DISCONNECT INPUT POWER BEFORE REPLACING FUSE.  FOR CONTINUED FIRE PROTECTION REPLACE ONLY WITH SPECIFIED TYPE AND RATED FUSE.		<b>LINE VOLTAGE RANGE</b>	<b>FUSE 250V</b>
		90-132V AC 180-250V AC	5A SLOW
		<b>POWER APPROX 110W</b> FREQ 48-440Hz	

**Fig. B**

# INSTRUCTIONS BEFORE USE

## Introduction

Thank you for purchasing Hitachi Denshi oscilloscope. In order to be able to use the instrument for a long time, read the manual carefully. Keep the manual together with the guarantee policy.

### 1. Guarantee range

The oscilloscope has strictly been quality controlled and inspected. If it has troubled at a normal operating status, it will be repaired according to the "Guarantee policy for Hitachi Denshi measuring instrument" furnished with the manual. If the policy is not provided, contact your local Hitachi Denshi sales office or sales agent.

### 2. After-sale service

The oscilloscope has been designed, manufactured and inspected so as to operate at a good condition upon different environmental tests taking into account various working circumstances on the user side. In case of fault, contact your local Hitachi Denshi sales office or sales agent.

### 3. Safety terms and marks

#### (1) Terms in manual

Warning ... If you do not observe a warning, an accident might injure the human body or affect the life.

Caution ... The caution covers matters which might damage the instrument or other devices connected to it.

#### (2) Marks

DANGER

The section marked "DANGER" may damage the human body or affect the life.

DANGER

High voltage in the instrument.

CAUTION

Refer to corresponding section in the manual.

Safety ground.



## SAFETY CAUTION

### WARNING

The instrument has high voltage sections. To avoid electric shock, do not remove the cover. Internal adjustment or part replacement must be done by qualified service personal.

### WARNING

The instrument uses a safety ground and a 3-wire AC power cord with 3-pin plug. The safety ground wire is connected to the metallic part of the instrument. To avoid electric shock, connect the safety ground to an AC outlet provided with a safety ground terminal.

Even when connecting the safety ground to a 2-wire AC outlet, using a 3-2 wire adaptor, be sure to connect the ground wire of the adaptor to ground.

### WARNIN

When connecting a probe or a signal input cable to the circuit under test, connect the ground side of the probe or the signal input connector to the ground of the signal source.

At a floating status, a potential might be produced with respect to other devices or ground, resulting in damaging the oscilloscope, probe, other measuring instruments, etc.

### WARNING

Use a fuse of specified rating. On the primary side of supply power, a 5A fuse is used to prevent the circuitry from being damaged by an overcurrent.

When this fuse is blown out, contact your nearest Hitachi Denshi representative. Do not try to use any fuse other than the specified ones.

Otherwise, further damage may occur and this could be dangerous.

(IMPORTANT: Use only the fuse of same size and rating as specified.)

Shape (Diameter x length)mm	Type
5.2 × 20	MT4-5A (250V 5A)

### WARNING

Do not operate the instrument in atmosphere containing combustible gas. There is a risk of explosion.

### WARNING

Do not try to insert metallic wire, pin or other metal pieces into the instrument. There is a risk of electric shock.

## NOTES TO USERS

### ① Caution for line voltage fluctuation

Use the instrument within the line voltage ranging from 90 to 132V AC or from 180 to 250V AC to ensure proper operation. If the line voltage is out of the specified range (when lower particularly), a normal operation could not be recovered even when a specified voltage is resumed.

### ② Action when display disappears from the screen

When this oscilloscope receives electric shocks including strong electrostatic noise from the outside, the internal circuit protection system may be automatically activated to stop supplying power to the internal circuits, having seemingly the same effect as power off.

When this system is activated, nothing is displayed on the CRT screen, all the LEDs on the panel go out and the fan stops rotating, even if AC power is supplied and the power switch is turned on.

To cancel this system, turn off the power switch once, and wait more than about one and a half minutes, then turn on the power switch again.

If the operation is not restored even if this action is taken, check that the fuse is not blown and contact your nearest Hitachi Denshi representative.

### ③ Notice for proper measurement

It is recommended to allow about 20 minutes after power on as warm-up time before starting measurement. Traces may drift a little just after power on.

When measuring a signal with high accuracy or caring about trace displacement in particular, you can correct the trace position using the automatic calibration function. Before starting up this function, allow enough warm-up time (about one hour).

### ④ Caution when built-in battery is consumed

This instrument is provided with a built-in battery and keeps calibration data, setup data, save data, etc. even after power off.

When the battery is consumed, the instrument will no longer keep data and will perform the following operation.

(1) Automatic calibration is performed without fail at power on.

(2) Setup is set to default when power is turned on.

(3) Saved waveform data and setup data are lost when power is turned off.

When the battery is about to be consumed, "Battery Empty" is displayed on the CRT screen.

If this message is displayed, contact your nearest Hitachi Denshi representative for replacement of the battery. The battery is consumed only when this instrument is turned off, and when the accumulated time of power off exceeds about two years, the battery will possibly be dead.

### ⑤ Caution when connecting plotter and personal computer

(1) When connecting a plotter and a personal computer, be sure to turn off this instrument, the plotter and the personal computer, and connect them with the power cords disconnected.

(2) Before operation, be sure to carry out the settings necessary for the plotter and the personal computer. (For the settings of the plotter and the personal computer, refer to the operation manual for each.)

If you should operate the plotter and the personal computer which are improperly set, abnormal operation will be caused.

In this case, turn off this instrument, the plotter and the personal computer once, and set them properly again and operate them.

# CONTENTS

<b>CHAPTER 1 GENERAL</b>	1-1
1.1 Features	1-1
1.2 Composition	1-2
1.3 Precautions	1-3
<b>CHAPTER 2 PANEL DESCRIPTION</b>	2-1
2.1 Panel Drawing	2-1
2.2 Function of each section	2-2
2.2.1 Front panel	2-2
2.2.2 Rear panel	2-5
<b>CHAPTER 3 HOW TO START UP INSTRUMENT</b>	3-1
3.1 How to start up instrument	3-1
3.1.1 Connection to power source	3-1
3.1.2 Power on	3-1
3.2 Setting by factory	3-1
3.3 Panel backup	3-1
3.4 How to obtain desired setup for measurement	3-2
3.5 Adjustment of brightness of CRT	3-2
3.6 Method for connecting signals	3-2
<b>CHAPTER 4 COMPOSITION AND OPERATION OF MENU</b>	4-1
4.1 General	4-1
4.2 How to display menu screen	4-1
4.3 How to operate menu	4-2
4.4 Fixed menu section	4-2
4.5 Page menu section	4-6
<b>CHAPTER 5 CRT READOUT</b>	5-1
5.1 Set value display	5-1
5.2 Display of measured values	5-3
<b>CHAPTER 6 FUNCTIONAL DESCRIPTION AND OPERATION</b>	6-1
6.1 RUN/HOLD/SINGLE operation	6-1
< Repetitive acquisition of signal and single shot sweep >	6-1
6.2 Auto setup function (AUTO SETUP)	6-2
< Automatic panel control for easy signal measurement >	6-2
6.3 Operation of vertical axis(CH1,CH2,CH3,CH4)	6-4
< Vertical axis operation by keys and knobs provided for each channel >	6-4
6.4 Selection of acquisition mode (MODE)	6-7
< 512W acquisition and 8kW, 2MW(VC-7524 only) acquisition >	6-7
6.5 Operation of time axis	6-12
< Setting of time axis range and measurement of pre-trigger and post-trigger sections >	6-12
6.6 Operation of trigger function	6-23
6.6.1 Edge trigger function (EDGE)	6-23
< Most popular trigger function- Edge trigger >	6-23
6.6.2 Trigger setup function	6-25
< Two sets of setup of edge trigger are selectable. >	6-25
6.6.3 Delay trigger function (DELAY)	6-25
< Capture of phenomenon caused after a given time >	6-25
6.6.4 Window trigger function	6-27
< Capture of both positive and negative signals >	6-27

6.6.5 Event trigger function	6-28
<Application of trigger by the number of phenomena occurred>	
6.6.6 TV trigger function	6-30
<Trigger when TV signal is measured>	
6.7 Display formats of waveform	6-33
<Overwrite display convenient for observation of jitter and noise>	
6.7.1 Overwrite display (PERSISTENCE)	6-33
6.7.2 Dot join display	6-34
6.7.3 How to clear waveform (CLEAR WAVEFORM)	6-35
6.8 Average mode (AVERAGE)	6-36
<Measurement of only basic signal component after eliminating mixed noises>	
6.9 Switching of scale (GRATICULE)	6-37
<Switching of scale display for easy measurement>	
6.10 Operation function (MATHEMATIC)	6-39
<Measurement of waveform obtained by calculating signals>	
6.11 Calibration (CALIBRATION)	6-49
<Optimization of measurement environments>	
6.12 Cursor measurement function(CURSORS)	6-54
<Numerical measurement of voltage and time differences between two points of waveform>	
6.13 Pulse parameter measurement function (PARAMETERS)	6-61
<Numerical measurement of waveform pulse parameters>	
6.14 Waveform search function (VC-7524 only)	6-67
<The acquired waveform is searched and displayed according to the setting conditions>	
6.15 GO-NOGO judgment function	6-70
<Automatic judgment of signals, compared with preset conditions>	
6.16 Save and recall of setup data (SETUP SAVE/RECALL)	6-79
<Recall of saved panel setup data to measure under the same conditions>	
6.17 Restoration to the settings before shipment	6-80
6.18 Waveform save function (WAVEFORM SAVE/RECALL)	6-81
<Save of waveform data to built-in memory and IC memory card>	
6.19 How to use built-in printer (PRINT)	6-86
<A hard copy of the data displayed on the screen is available using the built-in printer>	
6.20 Plot output function (PLOT)	6-88
<A hard copy of the data displayed on the screen is available, using an external X-Y plotter.>	
6.21 Clock function	6-94
<Recording of data and time together with waveform data>	
<b>CHAPTER 7 INPUT-OUTPUT INTERFACE</b>	7-1
7.1 RS-232C	7-1
7.2 GPIB	7-4
7.2.1 General	7-4
7.2.2 Specifications	7-5
7.3 VIDEO OUT(output)	7-7
<b>CHAPTER 8 PROGRAMMING FUNCTIONS</b>	8-1
8.1 General of programming functions	8-1
8.1.1 General	8-1
8.1.2 Setting instrument	8-1
8.2 Programming	8-1
8.2.1 Functions of interface	8-1

8.2.2 Programming syntax .....	8-1
8.2.3 Setting command syntax .....	8-2
8.2.4 Query command syntax .....	8-3
8.2.5 Mnemonic of unit .....	8-3
8.2.6 Sending and receiving waveform data .....	8-4
8.3 Programming grammar .....	8-5
8.3.1 Common command programming grammar .....	8-5
8.3.2 Root Level Commands .....	8-12
8.3.3 SYSTEM Commands .....	8-18
8.3.4 ACQUIRE Commands .....	8-20
8.3.5 CHANNEL Commands .....	8-23
8.3.6 DISPLAY Commands .....	8-26
8.3.7 MEASURE Commands .....	8-31
8.3.8 TIMEBASE Commands .....	8-42
8.3.9 TRIGGER Commands .....	8-44
8.3.10 WAVEFORM Commands .....	8-52
8.3.11 FUNCTION Commands .....	8-58
8.3.12 HARDCOPY Commands .....	8-60
8.3.13 GO-NOGO Commands .....	8-63
8.3.14 MEMORY Commands .....	8-67
8.4 Status report function .....	8-70
8.5 Programming example of receiving waveform data .....	8-71
8.6 Major causes for improper data transfer .....	8-72
<b>CHAPTER 9 SPECIFICATIONS .....</b>	<b>9-1</b>
9.1 Electrical .....	9-1
9.2 Dimensions .....	9-5
<b>APPENDIX A CALCULATION EXPRESSION OF PULSE PARAMETER .....</b>	<b>A-1</b>
<b>APPENDIX B SETTING BY FACTORY .....</b>	<b>B-1</b>

# CHAPTER 1 GENERAL

## 1.1 Features

This oscilloscope is an integrated type high speed digital oscilloscope which is capable of <observation>, <measurement>, <storage> and <hard copy production> in one unit.

### (1) Observation

- 100MS/s sampling on four channels simultaneously (two channels simultaneously for the VC-7502)
- 150MHz frequency bandwidth, full attenuator range of 2mV to 5V/div on all the four channels (two channels for the VC-7502)
- 8 bit vertical resolution and 8kw/ ch (2Mw/CH for the VC-7524) memory capacity
- Excellent operability equal to that of analog oscilloscope:

Keys and controls for the vertical axis, the horizontal axis and the trigger which are frequently used during signal observation are independently provided for each function and each channel, so that you can use this oscilloscope with a feeling similar to that of a familiar conventional analog oscilloscope.

- A variety of special trigger functions:

By selecting the most appropriate function in accordance with the nature of a signal, you can catch even a complex signal exactly and observe it promptly and properly.

- \* Trigger setup: Two pairs of setups for only trigger are stored. The trigger conditions can be set by calling one of the setups alternately at the touch of a button, which saves you the trouble of performing various settings again whenever the trigger signal is changed.
- \* TV full line select function: A specific field and line of a TV signal can be observed.
- \* Window trigger: In the case in which it is uncertain whether a signal occurs in the positive side or the negative side, the signal can be observed when the signal changes to more than a fixed level. This function is useful for observing a telephone line and a power supply circuit which contain noise.
- \* Trigger after delay, trigger after event: These functions are useful for observing plural signals of microcomputer peripheral circuits and logic circuits which occur asynchronously because of the complicated relationship.

- Auto setup:

The vertical axis, the horizontal axis and the trigger are automatically set with only a button, and a waveform is displayed in the state most suitable for observation.

- Channel skew calibration:

The time difference between channels due to the length of a cable or probe from the measured circuit can be adjusted in units of 40ps.

## **(2) Measurement**

- **Pulse parameter measurement:**  
Any four kinds of pulse parameters among 17 kinds of pulse parameters conforming to the IEEE standards are automatically measured simultaneously and displayed.  
Thus, it is not necessary to obtain the parameters by calculation each time.
- **Operating function:**  
Addition (+), subtraction (-), and multiplication (×) between signals, inversion of a signal, and absolute value operation are available. An ideal power waveform and a rectified waveform can be obtained from the electric current and voltage signals, and displayed.
- **GO-NOGO judgment:**  
By setting the judging conditions, an infrequent sudden trace can be automatically caught.
- **GPIB and RS-232C provided as standard:**  
By the full programmable function, the advanced automatic measuring system can be built in conjunction with a personal computer. The oscilloscope can be easily connected to a notebook type personal computer through RS-232C, so that the instrument can be readily systematized.

## **(3) Storage**

- **IC memory card slot provided as standard:**  
By installing the optional SRAM card, waveform data and measuring condition data can be stored in the card. A large capacity card of maximum 4M bytes can be installed, and a large quantity of data of about 300 waveforms can be stored. For the VC-7524, up to 2Mw waveforms can be stored.
- **Setup save/recall:**  
Maximum ten pairs of setups can be stored.  
If setups are stored once, the setups can be read as necessary and measurement can be started under the same conditions.
- **Panel backup:**  
The panel setting conditions at power off can be stored in the backup memory.  
At power on again, measurement can be carried out on the setting before power off.
- **Pixel save function:**  
A waveform displayed on the screen is stored as it is. A waveform of infinite time after glow display (over write) including the eyepattern signal of the communication line and the microcomputer bus can be saved.

## **(4) Hard copy production**

- **Built-in thermal printer provided as standard:**  
Acquired, important waveform data can be printed as it is on the screen by the built-in printer at the touch of a button to produce a hard copy. It is not necessary to take the trouble to prepare or connect another printer or plotter for printing.

## **1.2 Composition**

The composition of this oscilloscope is as follows:

(1) Oscilloscope, VC-7524/VC-7504/VC-7502	1 unit
(2) Accessories	
Probe AT-10AW1.5	2 pcs.
Fuse (5A)	1 pc.
Operation manual	1 copy
AC power cable (3-wire)	1 pc.
Recording paper for printer	1 roll

## 1.3 Precautions

### Installation

- Avoid installing the instrument in an extremely hot or cold place.
- Avoid placing the instrument in a place exposed directly to sunlight for a long time, in a car in mid-summer, or near a room heating device.
- The maximum operating ambient temperature is 40°C.

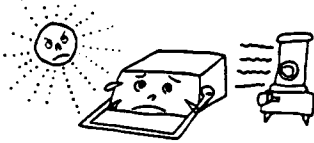

- \* Do not use the instrument outdoors for a long time on a cold winter day. The operating ambient temperature is 0°C or more.



- \* Avoid moving the instrument from a hot place to a cold place and vice versa, or condensation may form inside the instrument.

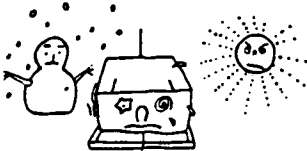

- \* Keep the instrument away from damp air, water, and dust. Unexpected trouble may be caused when the instrument is placed in a damp or dusty place.

The operating ambient humidity is 45 to 80%. Do not place a liquid-filled container on the instrument. An accidental intrusion of liquid may also cause troubles.



- \* Do not place or use the instrument in a place subject to vibration.



- \* Do not place the instrument near a magnet or a magnetic body. An oscilloscope uses electron beams. Therefore, do not bring a magnet close to the instrument or do not use the instrument near an equipment generating strong magnetic force.



### Operating considerations

- \* Do not put a heavy object on the instrument.
- \* Do not block ventilation holes.



- \* Do not apply a heavy shock to the instrument.



- \* Do not insert a wire, pin, etc. through ventilation holes.



- \* Do not drag the instrument with a probe connected.

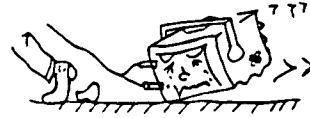

- \* Do not leave a hot soldering iron on or around the cabinet or the screen.

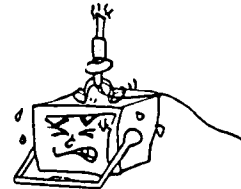

- \* Do not try to turn the instrument upside down. Otherwise, knobs may be broken.

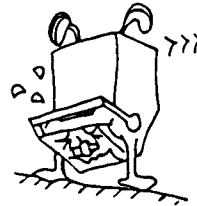

- \* Do not use the instrument upright, leaving cables connected to terminals or connectors on the rear panel. Otherwise, the cables may be damaged.

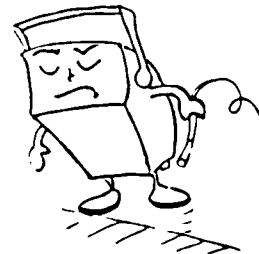



### When not in use

When not in use, put the dust cover on the instrument.

### Handle

Pull to both pivot points of the handle and turn to the desired position.



### Care

- \* Removal of stain from the case

- When the outside of the case is stained, wipe it lightly using a neutral detergent and then clean the surface with a dry cloth.



## «Maintenance and storage method»

- This instrument uses many transistors, diodes, ICs and precision parts.
- Wipe the display filter from time to time by a clean and soft cloth.
- Ideal ambient temperature and relative humidity for storing the instrument are 20°C and 65%.

## «Calibration period of this instrument»

The calibration is classified into the software calibration resorting to the automatic calibrating function in the menu and the hardware calibration for optimizing the internal circuitry in a wide range.

The software calibration is recommended when the ambient temperature has excessively changed (beyond 10°C) or when 1,000 operating hours or 6 months has been attained. If the trace is displayed excessively or when it is desired to optimize the measurement, execute it referring to the section 6.11 automatic calibration.

The hardware calibration is necessary to keep the instrument to a stable operation status. It is recommended to adjust the instrument every 2,000 operating hours or every year.

## «Caution before measurement»

- Check the line voltage.  
The operating voltage range for this oscilloscope is 90-132V AC or 180-250V AC. Before turning on the power switch, check the line voltage.  
This oscilloscope is provided with a power cable of lower than 125V AC rating as a standard. When using the oscilloscope on voltage higher than the voltage, it is necessary to replace the power cable. Contact your nearest Hitachi Denshi representative.
- Do not increase brightness too much.  
Do not increase brightness of a luminance spot or a trace too much. Excessive brightness may not only make the user's eyes tired but also burn the fluorescent screen of the CRT when the screen is left for hours in such a state.
- Do not apply an excessive voltage.  
The connector and probe input voltages are specified as follows.  
Do not apply higher voltages.  
Input direct: 400V(DC + AC peak, up to 1kHz)  
AT-10AW1.5 probe used: 500V(DC + AC peak, up to 1kHz)

### CAUTION

A higher voltage applied might damage the instrument. Never apply excessive input voltages.

# CHAPTER 2 PANEL DESCRIPTION

## 2.1 Panel Drawing

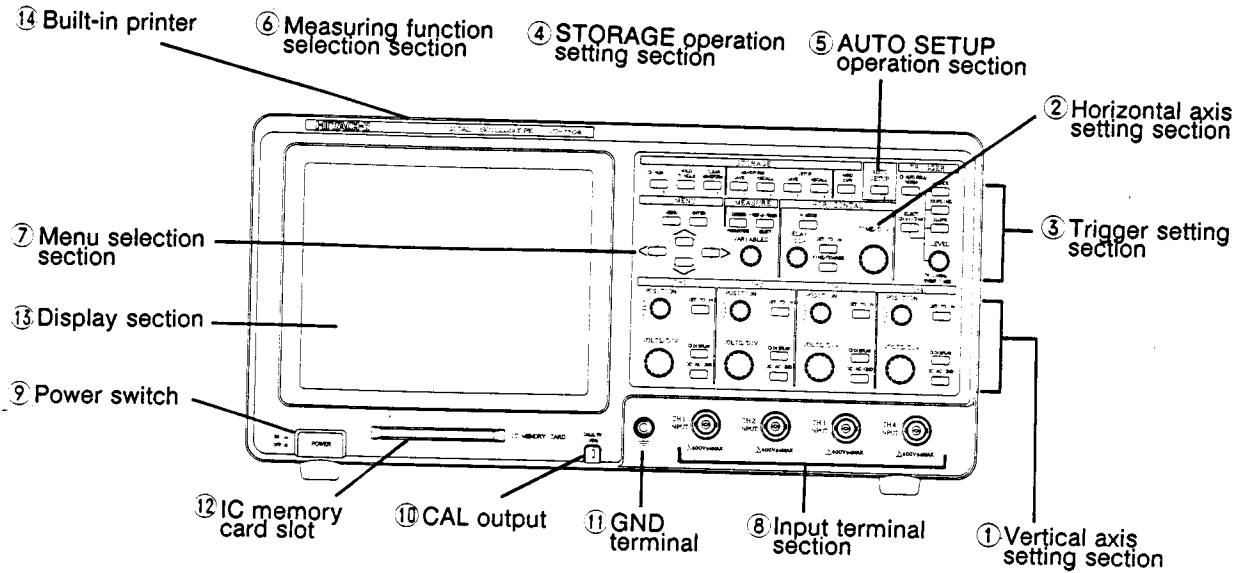

Fig. 2-1 Front panel(VC-7524\*1/VC-7504)

\*1) In case of the VC-7524, the model name VC-7524 is marked.

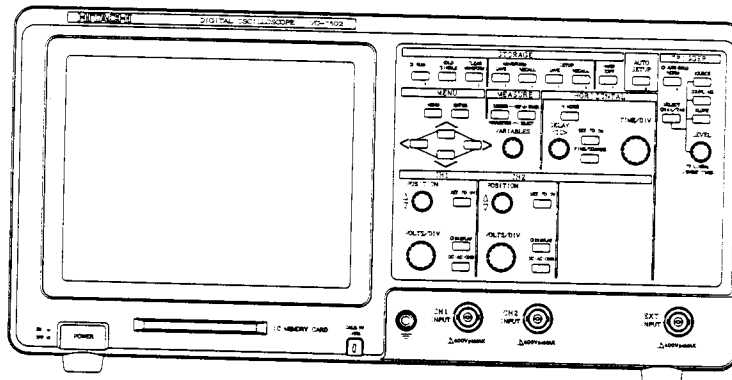

Fig. 2-2 Front panel(VC-7502)

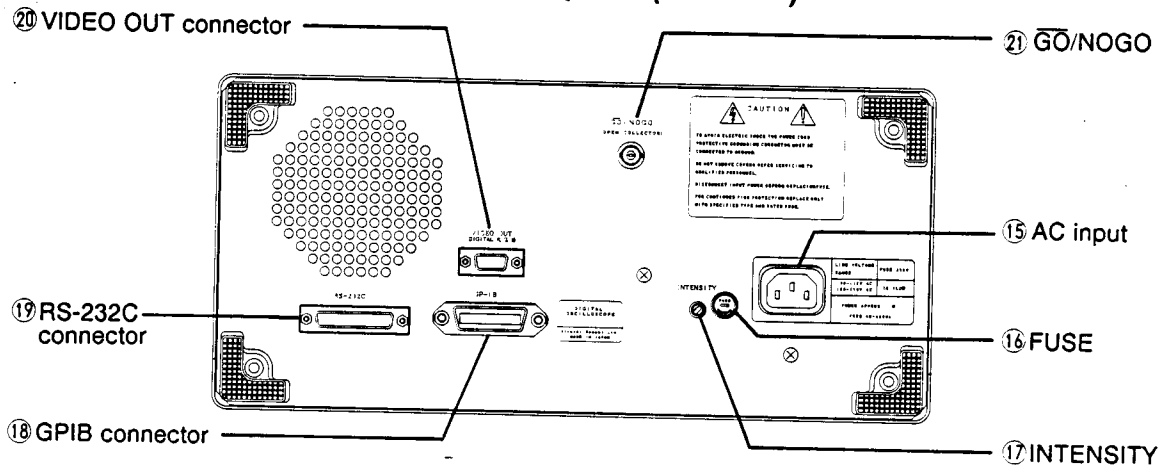

Fig. 2-3 Rear panel

## 2.2 Function of each section

### 2.2.1 Front panel

#### ① Vertical axis setting section

Controls and keys for setting the vertical axis range are provided in this section.

The controls and keys are provided independently for each of CH1 to CH4.

(CH1 to CH2 for the VC-7502)

DISPLAY



This key turns on or off waveform display. The LED on the upper left of the key is lit while a waveform is displayed (ON).

DC-AC-GND



This key switches input coupling.

Whenever pressing this key, the mode changes in the order of DC-AC-GND.

VOLTS/DIV



This control selects the vertical axis range.

Turn this control clockwise for a high sensitivity range, and turn this control counterclockwise for a low sensitivity range.

POSITION



This control moves the displayed waveform in the vertical direction.

Turn this control clockwise to move the waveform upward, and turn this control counterclockwise to move the waveform downward.

SET TO 0V



This key returns the waveform which is moved by the POSITION control to the original position.

When pressing this key during RUN, POSITION is reset to 0V and the GND marker is displayed on the center of the screen.

When pressing this key in the HOLD mode, the POSITION quantity moved after HOLD is reset.

#### ② Horizontal axis setting section (HORIZONTAL)

TIME/DIV



This control sets the sweep time.

Turn this control clockwise for a high speed sweep range, and turn this control counterclockwise for a low speed sweep range.

DELAY



This control sets the delayed quantity of a signal to be observed which is delayed from the trigger point of the signal used as a reference.

Turn this control clockwise to move the waveform so that the forward portion of the waveform is displayed, and turn this control counterclockwise to move the waveform so that the backward portion of the waveform is displayed.

SET TO 0s



This key resets the quantity of delay made by the DELAY control to 0. Press this key to display the trigger point on the center of the screen.

H MODE



This key switches the display mode of a waveform. Each pressing this key switches the display mode of a waveform to A (all sampled waveform data are compressed horizontally so that they are displayed on one screen) to ALT (all waveform data and the magnified waveform data are displayed on different scales) to B (a waveform magnified horizontally is displayed).

FINE/COARSE



This key switches the resolution of horizontal movement amount by the DELAY control when the H HOME switch is at ALT.

When this key is set to FINE, movement amount is small. When this key is set to COARSE, movement amount is large.

### ③ Trigger setting section (TRIGGER)

AUTO  
(ROLL)/NORM



Each pressing this key alternates the AUTO trigger mode and the NORMAL trigger mode. When the sweep time is 0.2sec/div or in a slower range, select the ROLL mode (AUTO mode) or the real-time sample mode (NORMAL mode) with this key. While the AUTO trigger mode (ROLL mode) is selected, the LED on the upper left is lit regardless of the TIME/div value.

SELECT  
 1st/2nd



Maximum two pairs of combination conditions can be selected from COUPLING, SOURCE, SLOPE and LEVEL as the trigger setting conditions.

Each pressing this key selects the other mode of the two pairs of 1st and 2nd alternately.

While the 1st is selected, the LED on the upper left is lit.

SOURCE



This key selects the trigger signal source. Each pressing this key selects the trigger signal source in the order of CH1-CH2-CH3-CH4.

(CH1-CH2-EXT-EXT ÷ 10 for the VC-7502)

COUPLING



This key switches and sets trigger coupling.

Each pressing this key selects, the coupling mode in the order of DC-AC-LFrej-HFrej.

SLOPE



This switch selects the trigger signal leading edge or trailing edge that triggers the sweep.

LEVEL



This control sets the trigger level. Turn this control clockwise to move the level upward on the screen, and turn this control counterclockwise to move the level downward on the screen.

In the TV LINE mode, use this control to set the number of TV LINE to be triggered, and in the TRIGGER AFTER EVENT mode, use this control to set the number of events.

### ④ STORAGE operation setting section (STORAGE)

RUN



Pressing this key starts acquiring data and continues to update the displayed waveform (that is, establishes the RUN status).

During RUN, the LED on the upper left of the key is lit.

HOLD  
/SINGLE



Pressing this key stops updating the displayed waveform and keeps displaying the last waveform (that is, establishes the HOLD status).

The LED on the upper left of the key goes out.

Pressing this key again in the HOLD mode starts a SINGLE sweep.

CLEAR  
WAVEFORM



Pressing this key clears the displayed waveform once. This function is convenient for use along with "overwrite", etc.

**Note:** When pressing this key in the HOLD status, the waveform is kept cleared.

WAVEFORM  
SAVE



Pressing this key stores the waveform data and measuring condition data in the save memory.

WAVEFORM  
RECALL



Pressing this key calls the waveform data stored in the save memory and display it on the screen.

**SETUP SAVE**

Pressing this key stores the setup conditions at the point in the setup save memory. The setup save memory is capable of storing ten pairs of setups. Each pressing this key stores one pair to ten pairs of setups in the memory in the order of memory number.

**SETUP RECALL**

Pressing this key calls the setup conditions stored in the setup save memory and sets the setup conditions for measurement. Each pressing this key calls the setup memory in the order of memory number.

**HARD COPY**

Pressing this key starts up the built-in thermal printer and an externally connected plotter to produce hard copy. Pressing this key again during operation for hardcopy stops the operation.

**⑤ AUTO SETUP****AUTO SETUP**

Pressing this key starts the auto setup function. This function automatically turns on or off display (turns on the display only on the channels having input signals) and optimizes the display waveform amplitude, the position, the trigger source and the sweep time.

**⑥ Measuring function selection section (MEASURE)****CURSORS**

This key selects either the cursor measuring function or the pulse parameter measuring function.

**PARAMETERS****REF.  $\Delta$  TRAC**

Pressing this key selects REF cursor, " $\Delta$ " cursor, or double cursor to move when performing cursor measurement. When performing pulse parameter measurement, press this key to select a parameter item to be measured and displayed.

**K SELECT****⑦ Menu selection section (MENU)****MENU**

This key turns on/off menu display. Each pressing this key alternates display and non-display of the menu.



Pressing this key moves the "menu select marker" (highlighted display portion by inverse image) upward.



Pressing this key moves the "menu select marker" downward.



Pressing this key moves the "menu select marker" leftward.



Pressing this key moves the "menu select marker" rightward.

**VARIABLES**

This control is used in relation to both the measuring function selection section and the menu selection section.

In cursor measurement, use this control to move the cursor. In pulse parameter measurement, use this control to select a measurement parameter at the parameter display position specified by the SELECT key. In menu display, use this control to change the data of the option selected by the marker.

**ENTER**

When this key is pressed, the setting value of the menu item selected by the menu selector marker (highlighted portion by inverse video) can be incremented.

⑧ **Input terminal section**

These are BNC connectors for input of a signal.

⑨ **Power switch**

● **POWER** This switch turns on or off power.

Holding down this switch turns on power, and holding up this switch turns off power.

⑩ **CAL signal output terminal**

● **CAL** This is an output terminal for the 1kHz, 0.5V square wave for probe calibration.

⑪ **GND terminal**

This is a ground terminal.

⑫ **IC memory card slot**

This is a slot for inserting the IC memory card.

⑬ **Display section**

A 7-inch raster scan type CRT is used.

⑭ **Built-in printer**

A thermal printer is equipped on the top of the body.

### 2.2.2 Rear panel

⑮ **AC input** Connect the power cable to this input.

⑯ **FUSE** A fuse is installed inside the fuse holder.

**CAUTION**

When the fuse is blown, contact your nearest Hitachi Denshi representative.

⑰ **INTENSITY**

This control adjusts brightness of the CRT.

⑱ **GPIB connector**

This connector is used to connect a personal computer with the GPIB interface and a plotter with the GPIB interface.

⑲ **RS-232C connector**

This connector is used to connect a personal computer with the RS-232C interface and a plotter with the RS-232C interface.

⑳ **VIDEO OUT connector**

The digital RGB video signal which can be connected to a multi-scan type display adaptable to IBM PC/AT is fed out from this connector.

To enlarge the display screen, connect the oscilloscope to an external monitor through this connector.

㉑ **GO/NOGO** When the GO-NOGO judgment function is used, this connector is used to output the judgment results. This is open collector output.



# CHAPTER 3 HOW TO START UP INSTRUMENT

## 3.1 How to start up instrument

### 3.1.1 Connection to power source

- (1) Connect the supplied power cable to the AC input on the rear panel.
- (2) Check that the POWER switch on the front panel is set to OFF (released state), then connect the power cable to an AC outlet.

If a three-wire outlet is available, be sure to connect the power cable to the three-wire outlet. If a three-wire outlet is unavailable, connect the power cable to a two-wire outlet using the supplied three-wire-two-wire conversion adaptor. In the case of the two-wire outlet, be sure to connect the ground cable running from the adaptor to an external ground.

### 3.1.2 Power on

Set the POWER switch below the CRT to ON (pressed state). The LED on the panel lights, and the scale display for waveform observation will appear in four to five seconds.

## 3.2 Setting by factory

When turning on the oscilloscope for the first time after purchase, the following screen is displayed. The panel settings are those set by the factory. For the settings by the factory, refer to APPENDIX B.

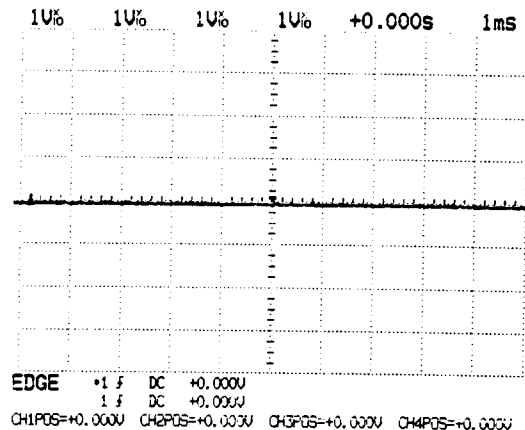

VC-7524/VC-7504

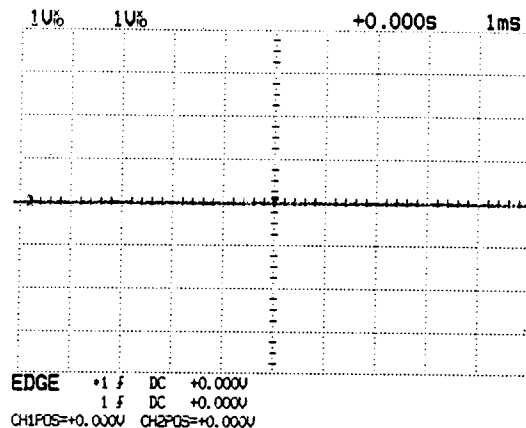

VC-7502

Fig. 3-1 Screen display set by factory

## 3.3 Panel backup

When turning on the oscilloscope again after using the instrument, the oscilloscope goes into the state of the last panel setting.

This oscilloscope is thus provided with the function which backs up setups by a battery, so that measurement can be carried out on the same setup as the previous setup by turning on the instrument which has been turned off during being not in use.



### 3.4 How to obtain desired setup for measurement

When the previous operator used the oscilloscope with much complicated panel setting, you may not know what setup is available when turning on the instrument. In this case, you can obtain the desired setup for your measurement speedily using the following three methods.

#### (1) Use of setup save memory

This oscilloscope is provided with the save memory which is capable of saving and recalling maximum ten pairs of set ups. By saving the desired setups for measurement using some of these setups, you can recall and return to the desired setup for measurement anytime.

For the details of setup save and recall, refer to section 6.16.

#### (2) Use of auto setup function

This function automatically establishes setups in accord once with the signal so that the waveform display of the input signal is optimum for measurement.

Waveform display ON/OFF, the vertical axis, the horizontal axis and the trigger are optimized in accordance with the signal, and other setups are set to fixed values.

Carry out this operation first to know the setup status, then change setups as necessary.

For the details and operation of auto setup, refer to section 6.2.

#### (3) Setting after restoring to setups by factory

When restoring to the setups (default) by the factory the setups shown in APPENDIX B are obtained.

In some cases, it may be faster to restore to the setups by the factory once and change a setup as necessary.

For how to restore to the default setups, refer to section 6.17.

#### (NOTICE)

When no waveform is displayed on the screen but the message "FULL CALIBRATION" is displayed to start auto calibration, contact your nearest Hitachi Denshi representative because the following causes will be considered.

- ① The built-in battery is dead. (In this case the message "Battery Empty" is displayed.)
- ② Data in the backup memory is destroyed for one cause or another.

### 3.5 Adjustment of brightness of CRT

The control for adjusting brightness is provided on the rear panel. Put a small screwdriver into the hole below the description INTENSITY and fit the end of the screw driver to the slit of the control, then turn the control clockwise and counterclockwise to change brightness.

Set the brightness of the CRT screen to that most suitable for measurement.

### 3.6 Method for connecting signals

The first step of measurement is to connect the signal to the instrument properly. Do it with utmost care.

**WARNING** : When connecting the probe or the signal input cable to the circuit to be measured, be sure to connect the ground side of the probe or the signal input connector to the ground side of the signal source.

If not, potential difference between the instrument and other equipment or earth ground may result in shock hazard and damage the instrument, the probe, and other equipment.

### (1) Using probes

Use the supplied probe to measure a high frequency signal accurately.

Supplied probe: AT-10AW1.5

When this probe is used with the  $\times 10$ ,  $\times 1$  select switch set to  $\times 10$ , the input signal to the oscilloscope is attenuated to  $1/10$ . This setting is convenient to measure a long signal because a measuring range is extended, though it is inconvenient for a small signal.

When a signal is too small to be measured with  $\times 10$ , use the mode  $\times 1$ . In this case, note that the input impedance of  $\times 1$  is different from that of  $\times 10$ , and the measurable frequency band becomes very low. (For details, refer to the operation manual of the supplied probe.)

#### NOTES:

- a) Do not apply a signal in excess of 500V (DC + peak AC at 1kHz or less) to the input.
- b) Connect the probe ground lead as close as possible to the point being measured especially when measuring a signal with a fast rise time or a high frequency signal. Long probe ground leads may cause waveform distortions, such as ringing and overshoot.

Connection of ground lead

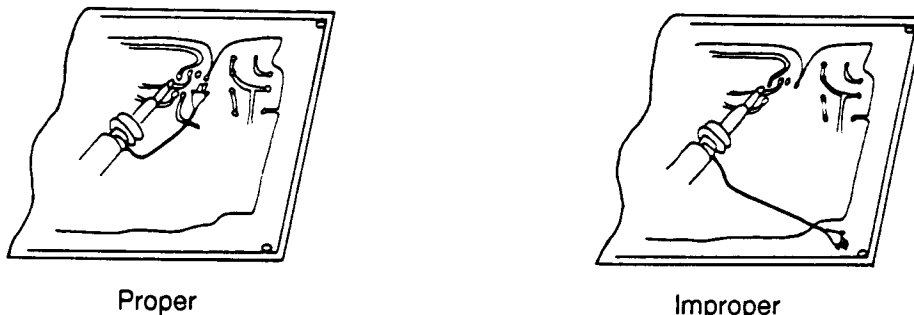

- c) To avoid effect of the ground lead in high frequency measurement, it is recommended to use the standard ground lead attachment with the AT-10AW1.5 probe.
- d) To avoid a measurement error, probe compensation must be done especially when probes are changed. Connect the probe tip to the PROBE ADJUST 0.5V output terminal and the probe ground lead to the GND terminal. A 1kHz square wave should be displayed with flat tops. Any distortion in the presentation is caused by incorrect probe compensation. If overshoot or undershoot is present, turn the screwdriver adjustment in the probe for a flat-top presentation.

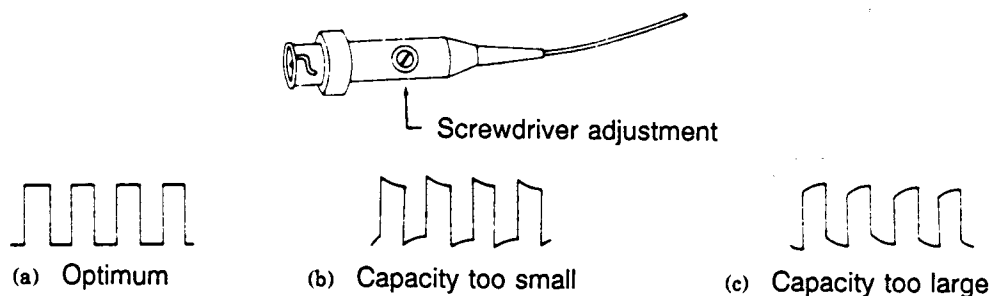

## (2) Direct connections

When connecting signals without using the supplied probe, pay attention to the following points in order to minimize a measurement error.

- When using an unshielded lead, there should be no trouble, provided the circuit under measurement is of low impedance source and high level. However, in most cases, measurement errors may be caused by stray coupling with other circuits or power line interference. This can cause errors even at low frequencies. In general, avoid measuring with an unshielded lead.
- When using a shielded wire, it is desirable to use a coaxial cable with a BNC type connector. If a BNC type connector is not available, connect one end of the shield to the ground terminal of the instrument and the other end to the ground of the circuit to be measured.
- The following precautions must be observed when performing a wide bandwidth measurement. It is necessary to terminate the cable with a characteristic impedance, when measuring a fast rise waveform or a high frequency wave. The absence of a termination resistor will result in a measurement error due to a ringing phenomenon when a long cable is used. Some measuring circuits require a termination resistor equal to the characteristic impedance of the cable. (A BNC type termination resistor is recommended for this purpose).
- In order to perform measurements with the circuit in a proper operating state, it is sometimes necessary to terminate the cable with an impedance which corresponds to the circuit being measured.
- The stray capacity of the shield wire must be taken into account when performing measurements with a long shield wire. Since a shield wire has a capacity of about 100pF per meter, its effect on the test circuit cannot be ignored. Use a X10 probe to minimize the effect on the circuit.
- When a shield wire or a non-terminated cable is used, and the cable length reaches 1/4 the wave length or its multiples (1/4 the wave length is about 0.5 meter when using a coaxial cable at 150MHz), oscillation may be caused in the 2 to 5mV/DIV ranges.  
This is caused by the resonance between the externally connected high - Q inductance and the input capacity. Reduce the Q by connecting the cable or shield wire to the input connector by the resistors from 100 $\Omega$  to 1k $\Omega$  connected in series, or by performing measurements at another VOLTS/DIV range.

# CHAPTER 4 COMPOSITION AND OPERATION OF MENU

## < NOTICE >

In each chapter of operation description of this operation manual, operation using the menu is described in the terms explained and defined in this chapter. Read this chapter carefully for comprehension before reading operation description in other chapters.

If you should not understand the operation related to the menu in another chapter, refer to this chapter.

## 4.1 General

An independent control or key is equipped for each function and channel on the operation panel of this oscilloscope for easy operation. Most of normal observation of waveforms can be carried out by operating controls and keys on the panel.

However, when using a rather unusual operation mode or setting an operating environment including interface, use the menu.

How to display menu screen, how to operate menu, and composition (fixed menu section and page menu section) are described below.

## 4.2 How to display menu screen

Press the MENU key in the MENU section of the operation panel to display the menu screen shown below. Press the MENU key again to clear the menu screen and change to a screen for observing a waveform. In this way, pressing the MENU key alternates display and nondisplay of the menu screen. (All typical display is an example of the VC-7504.)

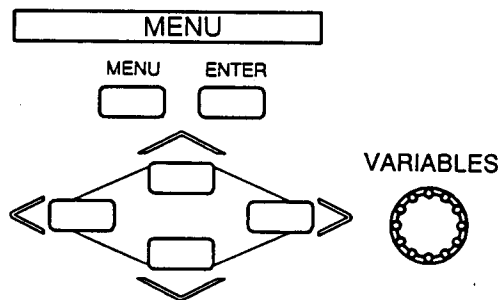
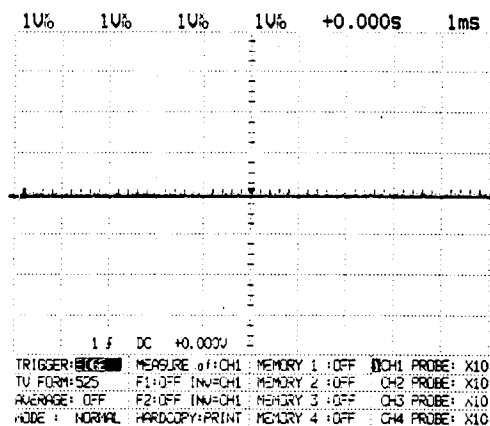

Fixed menu section      Page menu section

Keys in MENU section

Fig. 4-1 Typical display of menu screen

The menu section of the menu screen consists of the fixed menu section covering the three columns on the left, and the page menu section.

The fixed menu section is always displayed as long as the menu screen is displayed, and in the page menu section, menu items can be changed according to each page.

**< Definition of terms >**

- Fixed menu: Menu section covering the three columns on the left.
- Page menu: Menu section of the right column.

This menu consists of 11 pages (12 pages for the VC-7524) and enables selection of a page.

The number which is highlighted on the display by the highlight marker on the left end of the top row in the page menu represents a page number.

### 4.3 How to operate menu

There is one more item besides the page number in the menu screen which is highlighted by a highlight marker to show the selected item available for menu setting.

**(1) Change of menu selection item**

To select a menu item, move the marker horizontally and vertically with the four keys in the menu section.

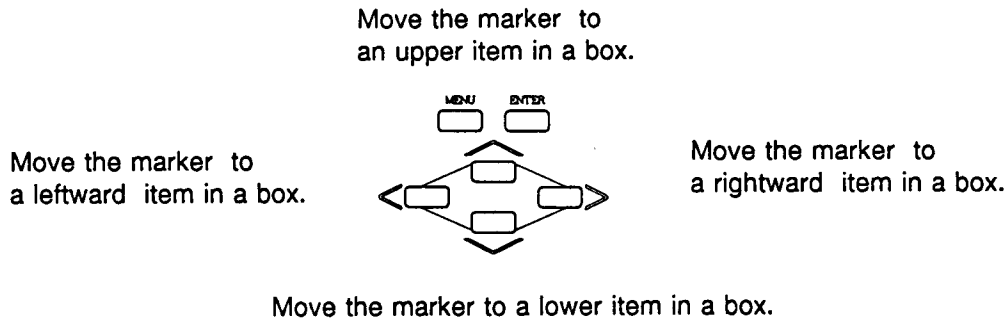

**Fig. 4-2 Key for changing menu selection item**

**< Note >** Some columns include more than one select item in one column of the menu. In such a column, the marker is moved leftward with the <  key and and moved right ward with the  > key.

**(2) Change of menu set value**

The set value is changed with the VARIABLE key or ENTER key in the MENU section. When exiting the menu screen, the displayed value is the menu set value which is applied to subsequent measurement.

### 4.4 Fixed menu section

Functions are provided in the fixed menu for which setting is changed most frequently next to the keys and controls on the operation panel.

Pressing the ENTER key once in the MENU section displays the fixed menu without fail, so that the fixed menu can be checked and the set value can be changed easily.

Menus shown in Fig. 4-3 are displayed in the fixed menu section.

**< Definition of terms >** How to specify item of fixed menu

The fixed menu is a table form menu which consists of four rows and three columns.

To specify one of these items (in boxes), specify it in the order of row and column.

For example, when specifying the third row from the top and the second column from the left in the fixed menu section, call as follows:

Fixed menu (third row, second column) or simply menu (third row, second column)

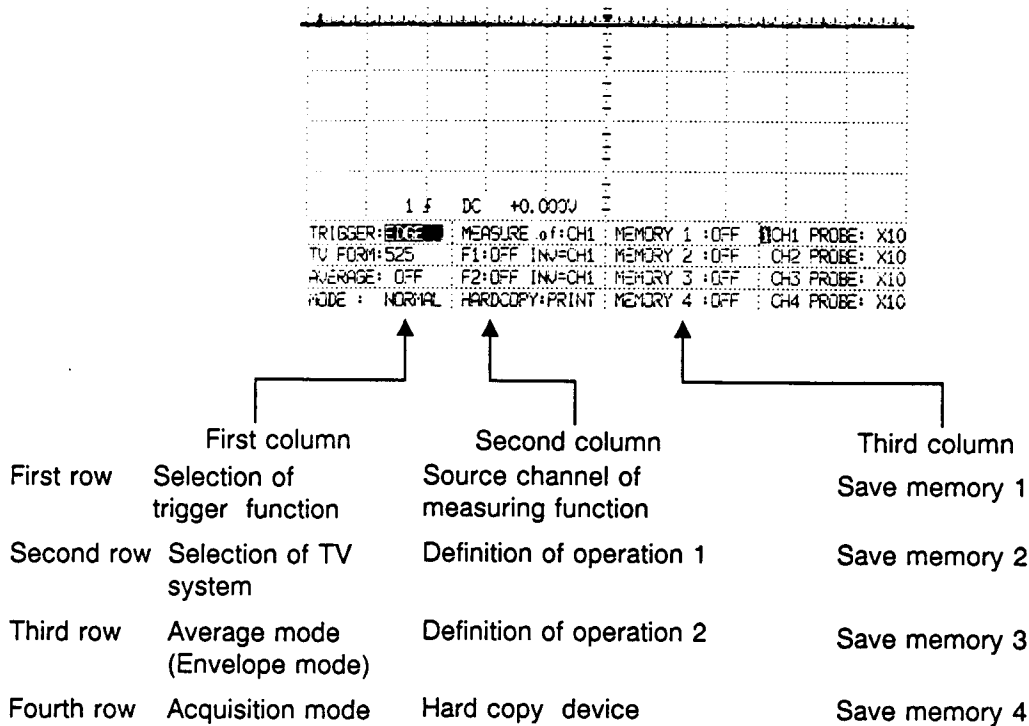

**Fig. 4-3 Display of fixed menu section**

The kinds of selectable choices in each item of the fixed menu and their meanings are listed below.  
 Menu (first row, first column) : Selection of trigger function

- TRIGGER:
- EDGE : Establishes edge trigger
  - DELAY : Establishes delay trigger.
  - EVENT : Establishes event trigger.
  - WINDOW : Establishes window trigger.
  - TV-V : Establishes TV V trigger.
  - TV-H : Establishes TV H trigger.
  - TVLINE : Establishes TV trigger line select mode.

Menu (Second row, first column): Selection of TV system

- TV FORM:
- 525 : Establishes NTSC system.
  - 625 : Establishes PAL system.

Menu (Third row, first column): Average mode

AVERAGE: — OFF : Turns off averaging.  
          └─ 2 to 256 : Turns on averaging  
                  (2<sup>n</sup>) (exponential averaging).  
                          Set the attenuation constant of exponential averaging by  
                          number.

Menu (Third rows, first column): Envelope mode

ENVELOPE: — 2-2048 : Sets the number of envelopes.  
           └─ (2<sup>n</sup>)  
                  INF : Sets the envelope of infinite times

Menu (fourth row, first column): Acquisition mode

MODE: — NORMAL : Establishes NORMAL operation mode.  
                  Data acquisition: 512w/CH  
                  Display: 512w/CH  
          └─ HI DENSE : Establishes HIGH DENSITY mode.  
                  Data acquisition: 8kw/CH  
                  Display: 8kw/CH  
          └─ LONG : Establishes the LONG operation model(large capacity data  
                  (VC-7524 collection mode).  
                  only) Data acquisition: 2Mw/CH(max.)  
                  Display: 1kw/CH  
          └─ SPLIT : Establishes the SPLIT operation mode(split memory mode).  
                  (VC-7524 Data acquisition: 512w/CH(min.)  
                  only) Display: 1kw/CH  
          └─ PK DETECT : PEAK DETECT mode is established.  
                  (VC-7502/04 Data acquisition: 1kw/CH, display: 1kw/CH  
                  only)  
          └─ ENVELOPE : ENVELOPE is established.  
                  Data acquisition: 1kw/CH, display: 1kw/CH(VC-7502/04)  
                  Data acquisition: 512w/CH, display: 1kw/CH(VC-7524)  
          └─ PILE : Establishes PILE operation mode.  
                  Data acquisition: 512w/CH  
                  Display: 8kw/CH

Menu (first row, second column): Source channel of measuring function

MEASURE of: — CH1 to CH4 : Select the channel signal from CH1 to CH4(CH1,  
                  M1 to M4 CH2 for the VC-7502), from M1 to M4 for which  
                  (CH1, CH2 for cursor measurement and parameter measurement  
                  the VC-7502) are carried out.

Menu (second row, second column): Definition of operation 1 (F1)

F1: — ON : Turns on calculation of and display of operation 1 (F1).  
      └─ OFF : Turns off calculation and display of operation 1 (F1).

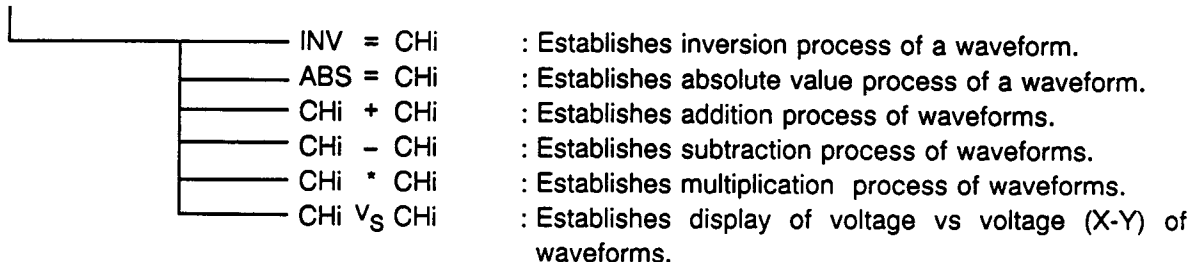

In any case, select for CHi the source channel signal for operation from CH1 to CH4. (CH1, CH2 for the VC-7502)

Menu (third row, second column): Definition of operation 2 (F2)

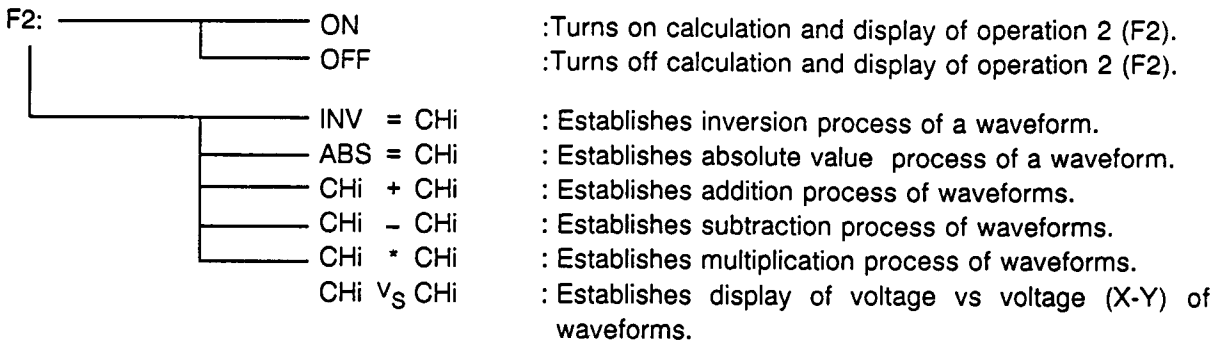

In any case, select for CHi the source channel signal for operation from CH1 to CH4. (CH1, CH2 for the VC-7502)

Menu (fourth row, second column): Hard copy device

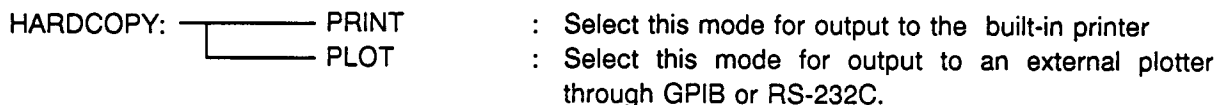

Menu (first row, third column): Save memory 1

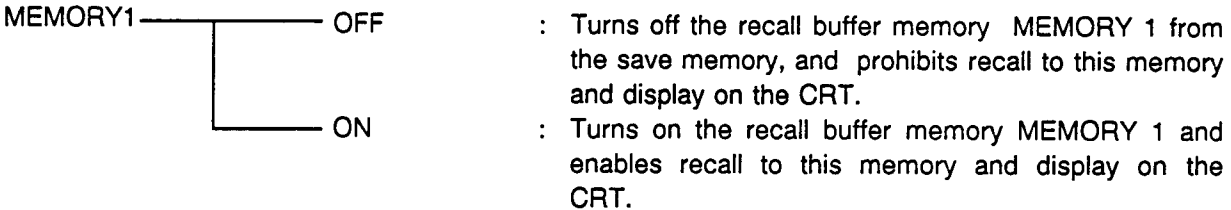

Menu (second row, third column): Save memory 2

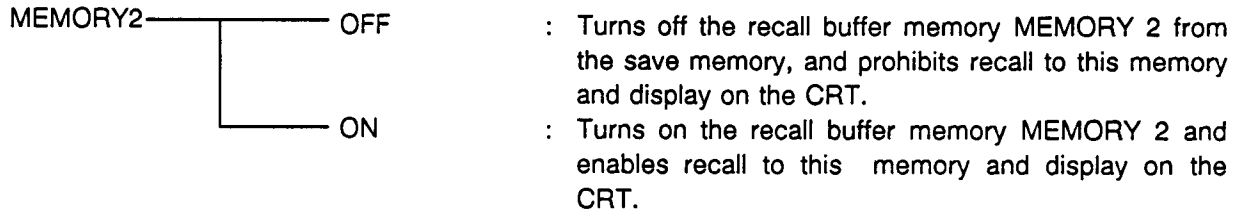



Menu (third row, third column): Save memory 3

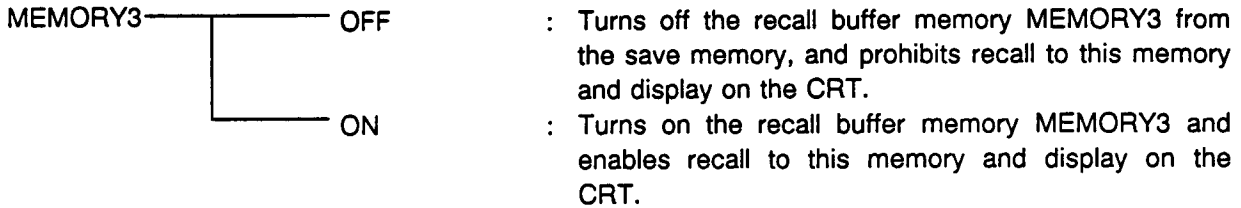

Menu (fourth row, third column): Save memory 4

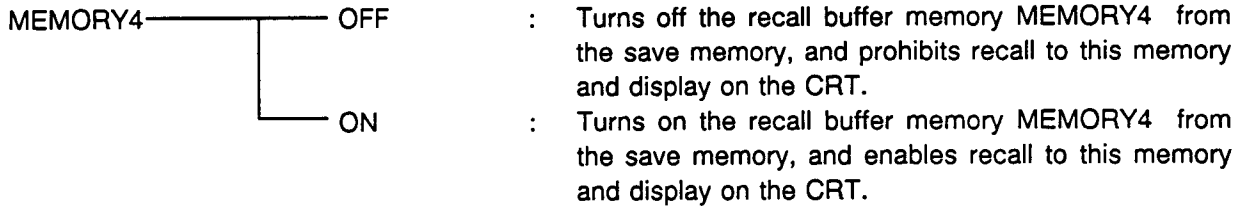

### 4.5 Page menu section

The page menu section consists of 11 pages (12 pages for the VC-7524) in all. When moving the highlight marker to the bottom row on a page and attempting to move the marker further, the next page is displayed. To the contrary, when moving the highlight marker to the top row on a page and attempting to move the marker further, the previous page is displayed.

**< Definition of terms >** How to specify item of page menu

The page menu is a table form menu which consists of 11 pages(12 pages for the VC-7524). To specify one of these items (boxes), specify it by calling the page and the row. For example, when specifying the item on the second row from the top on page 3 in the page menu section, call as follows: Page menu second row on page 3

1 f	DC	+0.000V	
TRIGGER: <b>EDGE</b>	MEASURE of: CH1	MEMORY 1 : OFF	CH1 PROBE: X10
TU FORM: 525	F1: OFF INV=CH1	MEMORY 2 : OFF	CH2 PROBE: X10
AVERAGE: OFF	F2: OFF INV=CH1	MEMORY 3 : OFF	CH3 PROBE: X10
MODE : NORMAL	HARDCOPY: PRINT	MEMORY 4 : OFF	CH4 PROBE: X10

### Page menu Page 1 (Probe factor on each channel)

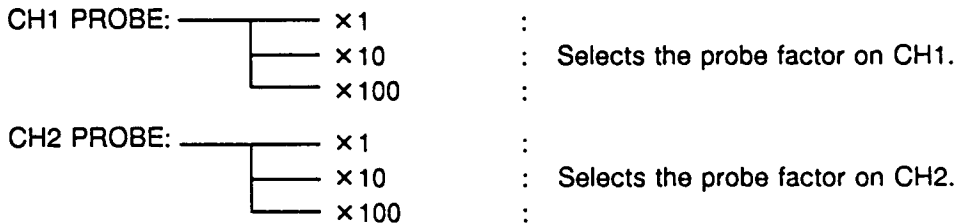

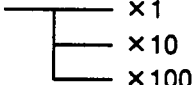
CH3 PROBE: (Not provided for the VC-7502)  ×1 :  
 ×10 : Selects the probe factor on CH3.  
 ×100 :

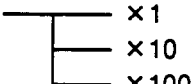
CH4 PROBE: (Not provided for the VC-7502)  ×1 :  
 ×10 : Selects the probe factor on CH4.  
 ×100 :

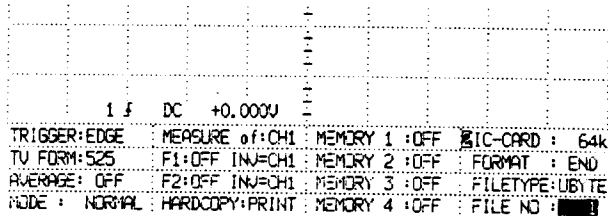

**Page menu Page 2  
 (Setting menu of IC memory card)**

IC-CARD: \_\_\_\_\_ 64k to 4096k : Selects the capacity for formatting the IC memory card. The capacity can be set in units of 64k bytes.

FORMAT: \_\_\_\_\_ END : Does not format the IC memory card.  
 \_\_\_\_\_ START : Executes formatting the IC memory card.

FILETYPE: \_\_\_\_\_ UBYTE : Select this mode to save and recall the latest waveform on each channel displayed on the CRT screen as separate data on each channel  
 \_\_\_\_\_ PIXEL : Select this mode to save and recall all the waveform data displayed on the CRT screen in the IC memory card as one piece of data

FILE NO: Select the file number to be saved and recalled in the IC memory card. (1 to 9999)

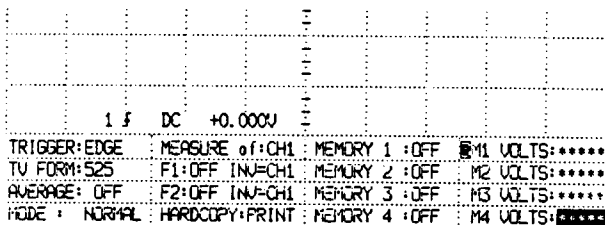

**Page menu Page 3  
 (Setting menu of recall waveform VOLTS/DIV)**

M1 VOLTS: Sets VOLTS/DIV of MEMORY 1.  
 M2 VOLTS: Sets VOLTS/DIV of MEMORY 2.  
 M3 VOLTS: Sets VOLTS/DIV of MEMORY 3.  
 M4 VOLTS: Sets VOLTS/DIV of MEMORY 4.

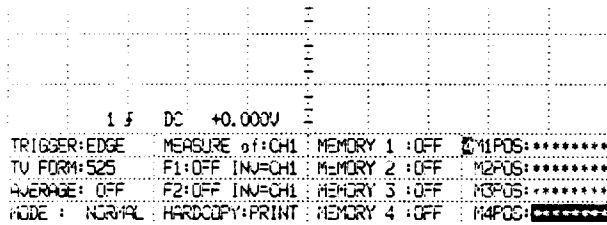

### Page menu Page 4 (Setting menu of vertical position of recall waveform)

- M1 POS: Sets vertical POSITION of MEMORY 1.
- M2 POS: Sets vertical POSITION of MEMORY 2.
- M3 POS: Sets vertical POSITION of MEMORY 3.
- M4 POS: Sets vertical POSITION of MEMORY 4.

**Note:**

When a waveform is not recalled or when a PIXEL waveform is recalled, the items corresponding to pages 3 and 4 of page menu are displayed as "\*\*\*\*\*".

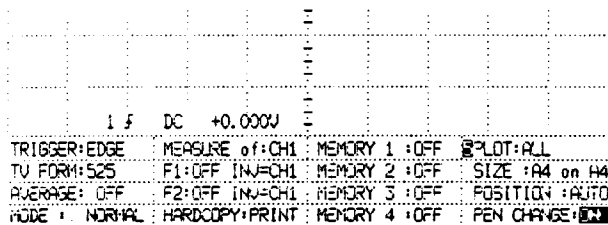

### Page menu Page 5 (Setting menu of plot output)

- PLOT:
  - ALL : Plots all the information.
  - WAVEFORM : Plots waveform data.
  - GRATICULE : Plots the grid, the scale and the cursor.
  - FACTORS : Plots the set and the measured values.
- SIZE:
  - A3 to A6 : Select the plot size A3, A4, A5 or A6
  - on A3, A4 : Select the paper size A3 or A4.
- POSITION:
  - AUTO : Plots a waveform in sequence.
  - 1 to 8 : Plots a waveform at a specified point.
- PEN CHANGE:
  - ON : Carries out replacement of a pen automatically.
  - OFF : Fixes to pen 1.

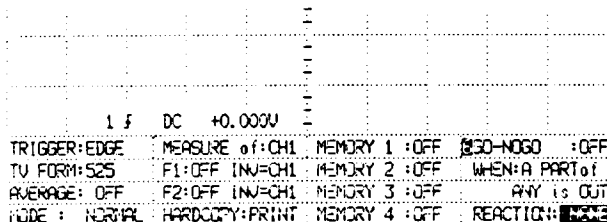

### Page menu Page 6 (Set menu of GO-NOGO judgment)

- GO-NOGO:
  - OFF : Turns off the GO-NOGO judgment function.
  - ON : Activates the GO-NOGO judgment function.
- WHEN:
  - A PART : Judges a part of a waveform to be measured.
  - ALL : Judges the whole of a waveform to be measured.
  - of ANY : Judges waveforms on all the channels of DISPLAY ON.
  - CH1 to CH4, F1, F2 : Selects a waveform to be judged from CH1 to CH4, F1 and F2.(CH1, CH2, F1 and F2 for the VC-7502)
  - is OUT : Judges to be NO GOOD when the waveform to be judged goes out of the judgment area.
  - IN : Judges to be NO GOOD when the waveform to be judged goes into the judgment area.
- REACTION:
  - NONE : Carries out nothing even when NO GOOD phenomena occur.
  - HOLD : Holds the waveform on the screen when NO GOOD phenomena occur.
  - SAVE : Saves the waveform in the built-in memory or IC memory card when NO GOOD pheno-mena occur.
  - PRINT : Produces hard copy on the built-in printer when NO GOOD pheno-mena occur.
  - SRQ : Feeds out the SRQ signal to the GPIB interface when NO GOOD phenomena occur.

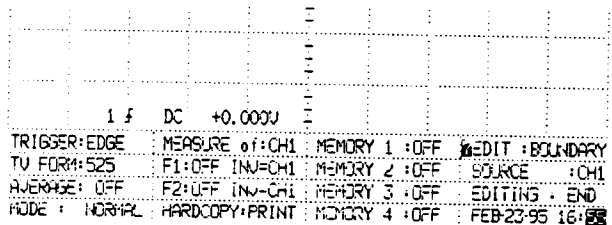

**Page menu Page 7  
(GO-NOGO judgment area creation menu)**

- EDIT:
  - BOUNDARY : Select this mode to create the judgment boundary of GO-NOGO.
  - RANGE : Select this mode to create the judgment boundary of GO-NOGO in the horizontal direction.
- SOURCE:
  - CH1 to CH4 : Select the reference waveform to create BOUNDARY.  
(CH1, CH2 for the VC-7502)
- EDITING:
  - Select START to start to create the judgment boundary of GO-NOGO and select END to finish the creation
- MONTH-DAY-YEAR  
HOUR:MINUTE:
  - Set time in the built-in clock in the order of month, day, year, hour and minute

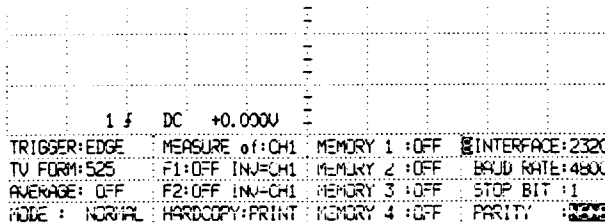

### Page menu Page 8 (Set menu of input and output interface)

- INTERFACE: \_\_\_\_\_ 232C : RS-232C can be used.
- \_\_\_\_\_ GPIB : GPIB can be used.
- MODE: \_\_\_\_\_ TALKONLY : Select this when connecting the plotter.
- \_\_\_\_\_ ADDRESSED : Select this when connecting the controller.
- MY ADDRESS: \_\_\_\_\_ 1 to 30 : Set the address of the GPIB interface of this oscilloscope.
- EOI: \_\_\_\_\_ ON : Turns on EOI when a delimiter occurs in the communication through GPIB.
- \_\_\_\_\_ OFF : Does not turn on EOI when a delimiter occurs.
- BAUD RATE: \_\_\_\_\_ 300 to 9600 : Set the baud rate of the RS-232C interface.(300, 600, 1200, 2400, 4800 or 9600)
- STOP BIT \_\_\_\_\_ 1, 2 : Sets the stop bit.
- PARITY \_\_\_\_\_ NONE : Sets the parity bit.
- \_\_\_\_\_ ODD
- \_\_\_\_\_ EVEN

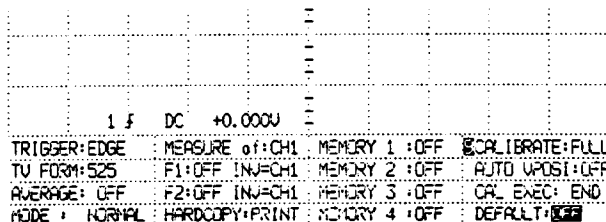

### Page menu Page 9 (Calibration menu)

- CALIBRATE: \_\_\_\_\_ FULL : Carries out automatic calibration for all the items.
- \_\_\_\_\_ VPOSI : Carries out only the calibration of the vertical axis offset voltage.
- \_\_\_\_\_ TRIG : Carries out only the calibration of the trigger skew.
- \_\_\_\_\_ SKEW : Carries out the skew calibration between channels.
- AUTO VPOSI: \_\_\_\_\_ OFF : Does not carry out periodic calibration automatically.
- \_\_\_\_\_ ON : Carries out only the calibration of the vertical axis offset voltage at fixed intervals.

**CAL:** Select **START** to execute the calibration specified by **CALIBRATE**. When the calibration finishes, **END** is established.

**DEFAULT:** When turning **ON** from **OFF**, the setup by the factory is called and set.

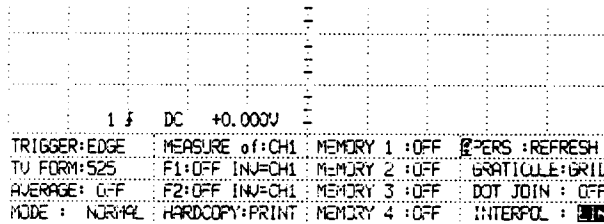

### Page menu Page A (Display menu)

- PERS:**
  - REFRESH : Clears the previous data and displays new data.
  - INFINITE : Does not clear the previous data, but overwrite data one after another.
- GRATICULE:**
  - GRID : Displays all the frame, the axes, and the scales.
  - FRAM : Displays only the frame.
  - AXES : Displays the frame and the axes.
- DOTJOIN:**
  - ON : Connects between waveforms by a straight line and displays them.
  - OFF : Displays waveform data by dots.
- INTERPOL:**
  - SIN : Inserts sine-interpolated data between waveform data in the magnified waveform mode.
  - LIN : Inserts linear-interpolated data between waveform data in the magnified waveform mode.
  - OFF : Interpolation is not performed in the magnification mode.

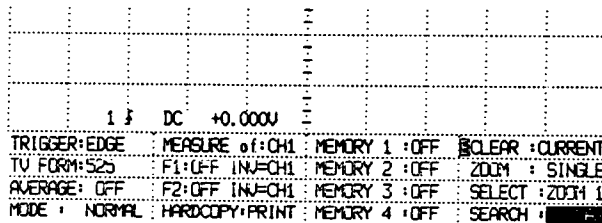

### Page menu Page B

- CLEAR:**
  - CURRENT : All waveforms except for recalled waveforms are cleared.
  - RECALL : Only recalled waveforms are cleared.
  - ALL : All waveforms are cleared.
- ZOOM:**
  - SINGLE : The magnified waveform data of one section are displayed on one screen.
  - DUAL : The magnified waveform data of two sections are displayed on two screens.

- SELECT:      ┌── ZOOM1      : Select to set the delay of magnified waveform1.  
                  └── ZOOM2      : Select to set the delay of magnified waveform2.
- SEARCH:      ┌── MAX            : Retrieves the block with the waveform data whose  
 (VC-7524 only) │                            value exceeds the value indicated by the horizontal  
                  │                            cursor in the large capacity collection mode or the  
                  └── MIN            : Retrieves the block with the waveform data whose  
                  │                            value is lower than the value indicated by the  
                  │                            horizontal cursor in the large capacity collection  
                  └── PATTERN       : Retrieves the segments conforming to or not  
                  │                            conforming to the judgment region in the memory  
                  │                            split mode.  
                  └── SCREEN        : The magnified waveform displayed on one screen is  
                  │                            scrolled as one block to left or right in LONG or  
                  │                            SPLIT mode.

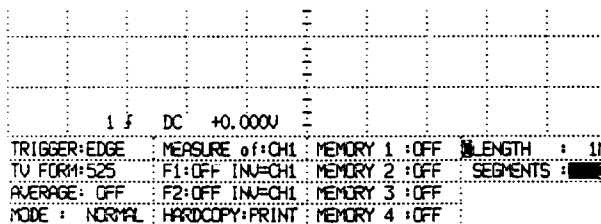

**Page menu Page C(VC-7524 only)**

- LENGTH:      ┌── 2M            : When the acquisition mode is LONG, the acquired  
 (VC-7524 only) │                            data is 2Mw/CH.  
                  │                            1M            : When the acquisition mode is LONG, the acquired  
                  │                            data is 1Mw/CH.  
                  │                            500k        : When the acquisition mode is LONG or SPLIT, the  
                  │                            acquired data is 500kw/CH.  
                  │                            100k        : When the acquisition mode is LONG or SPLIT, the  
                  │                            acquired data is 100kw/CH.  
                  │                            50k         : When the acquisition mode is LONG or SPLIT, the  
                  │                            acquired data is 50kw/CH.  
                  │                            10k         : When the acquisition mode is LONG or SPLIT, the  
                  │                            acquired data is 10kw/CH.  
                  │                            1k          : When the acquisition mode is LONG or SPLIT, the  
                  │                            acquired data is 1kw/CH.  
                  └── 512            : When the acquisition mode is LONG or SPLIT, the  
                  │                            acquired data is 512w/CH.
- SEGMENT:      ┌── 2-2000        : Sets the number of split data in the memory split  
 (VC-7524 only) │                            mode.

# CHAPTER 5 CRT READOUT

This chapter describes the contents of readout display on the CRT.

Press the MENU key in the MENU section to clear the menu screen and display the screen for observing a waveform, and readout display of the set value and measurement results can be viewed in accordance with each operation mode. (All typical display is an example of the VC-7504.)

## 5.1 Set value display

When observing a waveform, the set values set on the operation panel and the menu, and the measured values including the cursor measured value, and the pulse parameters are displayed on the CRT in the arrangement shown below:

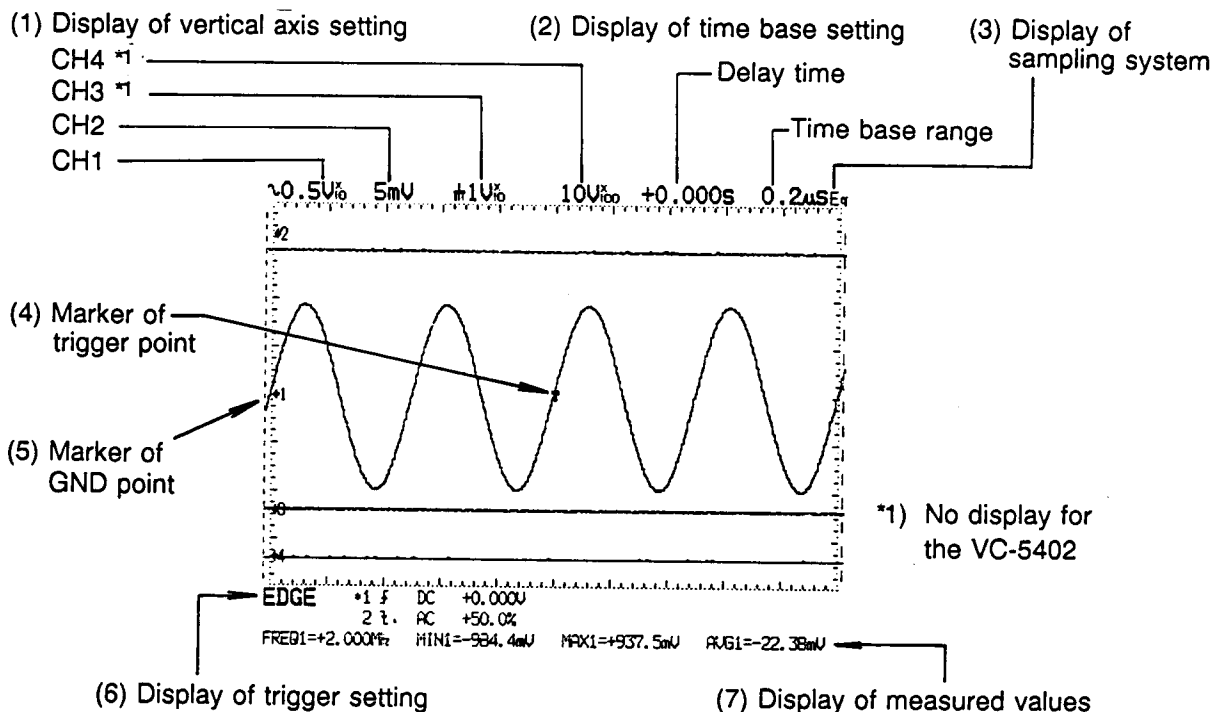

Fig. 5-1 Typical display of set values

### (1) Display of vertical axis setting

The set values of the vertical axis are displayed.

The set values are displayed in the order of CH1, CH2, CH3 and CH4 (CH1 and CH2 for the VC-7502) from the left.

The setting value of the vertical axis of the channel whose DISPLAY is OFF is not displayed.

The display on each channel contains set values of the coupling, the vertical range and the probe factor.



## Typical display of vertical axis setting

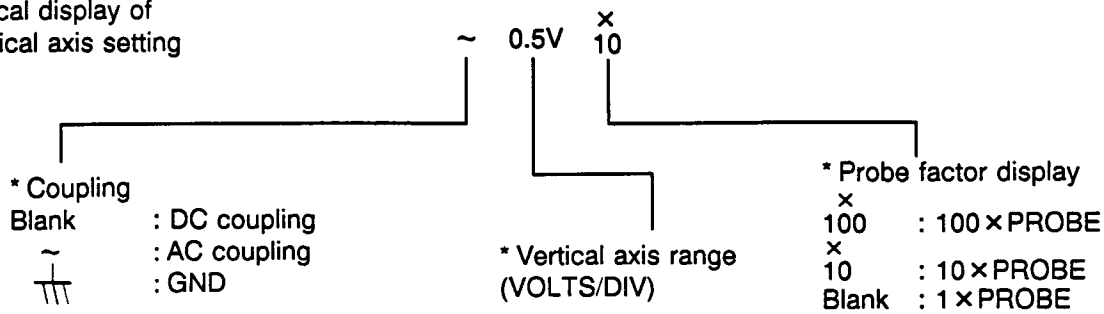

## (2) Display of time base setting

The delay time (left) and the time base range (right) are displayed. When TIME/DIV is changed, a sampling rate is momentarily displayed below the time axis range.

Delay time: Shows the delay time from the trigger point on the vertical axis at the center of the screen.

Time base range: Shows the value set by the TIME/DIV control.

## (3) Display of sampling system

This section shows which sampling system the waveform display is based on,

Blank: Real-time sampling system

Eq: Equivalent sampling

Ro: ROLL mode

Av: Average mode

PD: PEAK DETECT operation of realtime sampling

PR: PEAK DETECT operation of ROLL mode

Ev: Envelope operation of realtime sampling

EE: Envelope operation of equivalent sampling

## (4) Marker of trigger point

This marker shows the horizontal position and the level of the trigger point.

## (5) Marker of GND point

This marker shows the position of the GND level on the screen. The position is displayed for the channel of DISPLAY ON.

## (6) Display of trigger setting

The set trigger function and two pairs of trigger setups are displayed. One of two pairs of trigger setups can be selected alternately by pressing the SELECT 1st/2nd key.

The setup is displayed in the order of SOURCE, SLOPE, COUPLING and the trigger level.

When the menu is displayed, the setting value selected by the SELECT key is displayed at the bottom left of the scale.

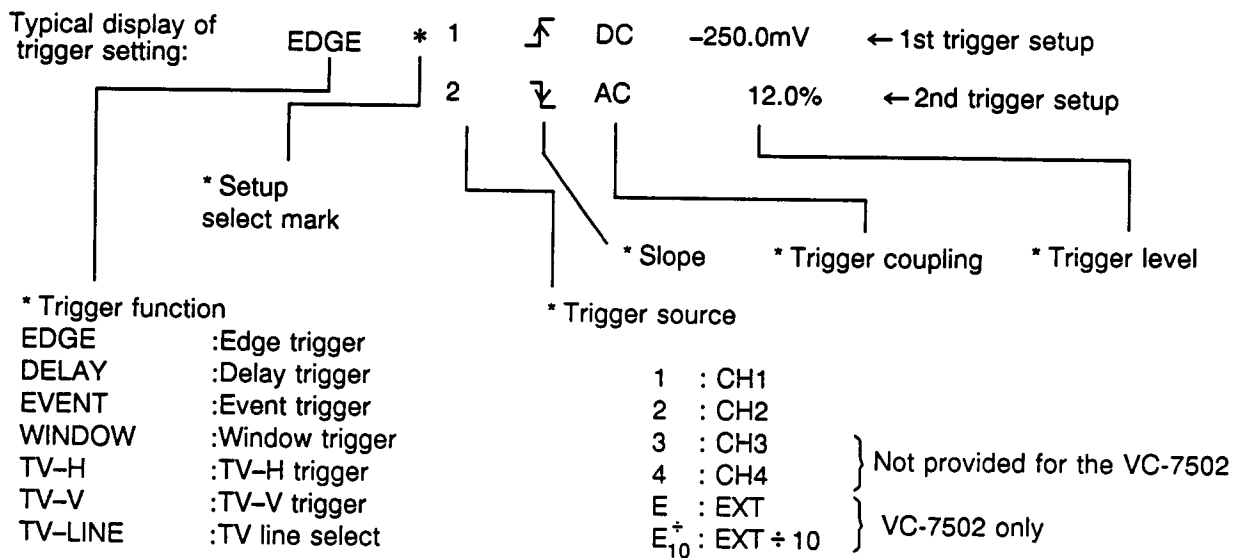

## 5.2 Display of measured values

When selecting the functions of cursor measurement and the pulse parameter measurement with keys in the MEASURE section of the operation panel, the measured values are displayed at the position of Fig. 5-1 (7).

In this case, the vertical axis position (POSITION) is not displayed.



## CHAPTER 6 FUNCTIONAL DESCRIPTION AND OPERATION

This chapter describes the functional description and operation.

All description is for the VC-7524/VC-7504, but is almost same for the VC-7502.

In addition to the functions available by the keys and knobs on the operation panel, the functions operated by using menus are included.

For the keys and knobs on the operation panel, see Chapter 2. For the configuration, operation and terminology of menus, refer to Chapter 4. In this chapter, the description is made on the assumption that Chapters 2 and 4 have been understood. Therefore, if some query arises, read Chapters 2 and 4 again.

### 6.1 RUN/HOLD/SINGLE operation

< Repetitive acquisition of signal and single shot sweep >

Whether the acquisition and display of a signal are made continuously or whether the acquired signal is held for detailed observation can be selected by the RUN key and the HOLD/SINGLE key.

#### (1) RUN function

○ RUN



When the RUN key at the STORAGE section is pressed and its LED is being lit, data is acquired and displayed continuously.

When trigger is not applied and trigger wait state is established, the data on the screen is not updated even in the RUN mode. Check that the relationship between the trigger setting and the signal is correct.

#### (2) HOLD function and SINGLE operation

HOLD/  
SINGLE



##### ① HOLD function

When the HOLD/SINGLE key is pressed while data is displayed repeatedly in the RUN mode, only the data acquired last is displayed continuously on the screen. This state is called the HOLD state. In this case, the RUN key LED goes off.

Though a new signal is not acquired in the HOLD state, it is possible to observe the displayed data by moving the waveform vertically, magnifying it horizontally or moving the magnified waveform horizontally.

HOLD/  
SINGLE



##### ② SINGLE operation

When the HOLD/SINGLE key is pressed in the HOLD state, a single shot sweep is performed. When the key is pressed, a signal is acquired and displayed only once, then the HOLD state is established again.

When performing a single shot after setting the trigger mode to AUTO, a signal is acquired and displayed even though trigger is not applied by the signal. Therefore, this can be used to check the steady state level of a DC signal or in no-signal mode. When a single shot is activated after setting the trigger mode to NORM, the wait state continues until trigger is applied by the signal, and the acquisition of the signal ends after trigger is applied. Then, the displayed waveform is updated.

This is convenient to measure a single shot phenomenon like mechanical vibration, impact, explosion or electrical signal.

## 6.2 Auto setup function (AUTO SETUP)

< Automatic panel control for easy  
signal measurement >

**Functional description** Front panel setting can be performed automatically so that optimum waveform display can be obtained for an input signal.  
With this function, the following items can be set automatically according to the characteristics of the signal

- \* ON/OFF of waveform display (DISPLAY)
- \* Horizontal axis (TIME/DIV)
- \* Vertical axis (VOLTS/DIV)
- \* Trigger (SOURCE, LEVEL)

**Operation method** Connect the signal to be measured to the input BNC connector.  
At this time, connect the signal to be seen as the reference of the time axis and trigger to the channel labeled the youngest number.

### AUTO SETUP



Press the AUTO SETUP key.

**Operation conditions** (1) The auto setup function is effective only for the stable repetitive input signal.  
(2) For stable operation, it is needed for the input signal to satisfy the following conditions.

- Frequency: 20Hz to 20MHz
- Duty factor: 20 to 80%
- Amplitude: 5mV to 50V

For example, when an input signal is a square wave of 20MHz, the pulse width in excess of 10ns is needed.

When an input signal having an amplitude of approximately 5mV or less, the signal is judged to be absent.

### Operation

- (1) When an effective signal is connected to more than one channel, the channels to which the signal is connected become DISPLAY ON, and the waveforms are displayed.  
No-signal channels become DISPLAY OFF and waveforms are not displayed.
- (2) When a signal is connected to plural channels, the horizontal axis and trigger are set to the channel labeled the youngest number. The vertical axis sensitivity is set to each channel to which the signal is connected.

### List of settings

With the auto setup function, the following settings are performed.

- (1) Items changed automatically according to the characteristics of an input signal

**Table 6-1**

Item	Name	Setting	No signal on all channels
Waveform display	DISPLAY	Channels to which a signal is connected are set to ON. Channels to which a signal is not connected are set to OFF.	All channels: ON
Vertical axis sensitivity	VOLTS/DIV	Set so that amplitude of displayed waveform becomes approximately 2-5div <sup>*2</sup>	All channels: 100mV/div <sup>*1</sup>
Vertical axis position	POSITION	Average level of waveform is set to center of screen	CH1 300mV <sup>*1</sup> CH2 100mV CH3 -100mV <sup>*3</sup> CH4 -300mV <sup>*3</sup>
Time axis range	TIME/DIV	Set so that the signal of the youngest number channel is displayed for 2-5 cycles.	1ms/div
Trigger source	SOURCE	The youngest channel having a signal is selected.	ch1
Trigger level	LEVEL	Around the center of the amplitude of the channel selected as a trigger source	0V

\*1 When probe factor is set to  $\times 10$ : 1V/div

When probe factor is set to  $\times 100$ : 10V/div

\*2 When plural channels are ON, the sensitivity and position of the vertical axis are adjusted by the number of the ON channels.

\*3 Not provided for the VC-7502.

**(2) Items set regardless of input signal**

**Table 6-2**

Item	Name	Setting
Storage mode	RUN,HOLD	RUN
Input coupling	COUPLING	DC
Trigger type	TRIGGER	EDGE
Trigger mode	AUTO/NORM	AUTO
Trigger coupling	COUPLING	DC
Trigger setup	SELECT 1st/2nd	1st
Delay time	DELAY	0 sec(Center of screen)
Trigger slope	SLOPE	Rise

## 6.3 Operation of vertical axis(CH1,CH2,CH3,CH4)

<Vertical axis operation by keys and knobs provided for each channel >

### (1) ON/OFF of channel

○DISPLAY



Press the DISPLAY key to display the input signal of each channel.

The channels which the DISPLAYED key LEDs are lit are ON, and their waveforms are displayed.

Only the waveform and vertical axis setting value of the channel whose LED is lit are displayed.

### (2) Setting of input coupling

DC·AC·GND



DC, AC and GND are available as the input signal coupling and selected by the DC-AC-GND key for each channel.

The selected coupling mode is displayed as a symbol on the display section of the vertical axis setting value at the top left of the screen.

DC: An input signal is connected directly to the amplifier, and the signal including a DC component is displayed.

(Symbol displayed on vertical axis setting value section: No symbol)

AC: An input signal is connected to the amplifier via a capacitor.

A DC component is eliminated and only an AC component is displayed.

(Symbol displayed on vertical axis setting value section: ~)

GND: An input signal is separated and the input signal to the vertical amplifier is grounded.(Symbol displayed on vertical axis setting value section:  $\overline{\text{TTT}}$  )

### (3) Setting of vertical axis sensitivity

VOLTS/DIV



The vertical axis sensitivity is set by the VOLTS/DIV knob provided for each channel.

The set sensitivity is displayed at the top left of the screen in the order of CH1, CH2, CH3 and CH4(CH1 and CH2 for the VC-7502).

Range of setting value

When PROBE FACTOR is x1: 2mV-5V (1-2-5 steps)

When PROBE FACTOR is x10: 20mV-50V (1-2-5 steps)

When PROBE FACTOR is x100: 200mV-500V (1-2-5 steps)

### (4) Vertical movement of waveform

POSITION



-The waveform of a channel can be moved vertically by the POSITION knob of the corresponding channel.

Though the mark ←1 displayed at the inside of the left edge scale line indicates the GND level of the channel indicated by a number, this mark is moved accordingly by the POSITION knob.

### ① Readout of vertical position

When the waveform measurement operation mode is established, the vertical position of each channel is read out as illustrated below.

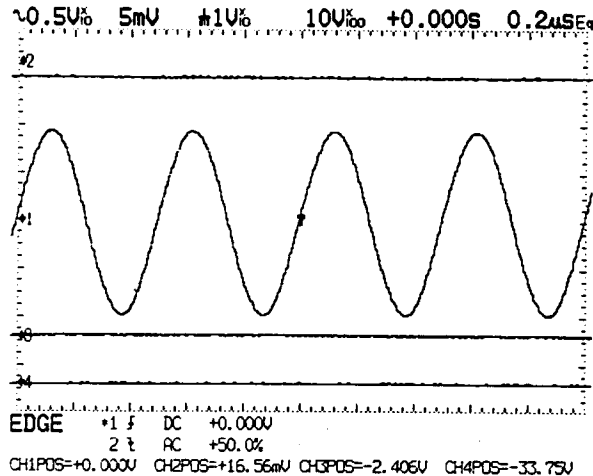

**Fig. 6-1 Example of vertical position read-out (During RUN mode)**

This indicates the GND position of each channel with respect to the horizontal center line. If the GND position of a channel is above the horizontal center line, the sign + is added. If it is below the horizontal center line, the sign - is added. When this value is read, it is possible to know the voltage level of the measured signal with respect to the GND of the channel.

(Note) To display the read-out of the vertical position,

- (A) Allow the menu display to disappear, and
- (B) Make the cursor measurement and the pulse parameter measurement of the MEASURE function off.

### ② Vertical movement and reset to OV in RUN mode

Sampling of data is performed, while applying the voltage corresponding to the amount of vertical movement to the input signal, and the result is displayed.

(Note) When the vertical movement is continued by rotating the POSITION knob, the waveform is tracked slowly because of the voltage setting work.

SET TO OV



The read-out of the vertical position in the RUN mode is displayed as shown in Fig. 6-1. When the vertical position in the RUN mode is set to other than OV, press the SET TO OV key. Then, the POSITION of the corresponding channel is reset to OV, and the GND point is displayed at the center of the screen.

### ③ Vertical movement after HOLD and reset of vertical movement amount.

The waveform held on the screen can be moved vertically and displayed.

When the waveform held on the screen is superimposed on other signal or scale, the waveform held on the screen can be moved for easy measurement.

When the vertical position is moved after HOLD, only the channel of the signal whose vertical position is different from that in the HOLD mode is reversed as shown in Fig. 6-2.



SET TO 0V



This reversed display disappears when the value is returned to that in the HOLD mode by the POSITION knob.

When the RUN mode is established again, the HOLD mode is set to maintain the position movement amount in a possible range.

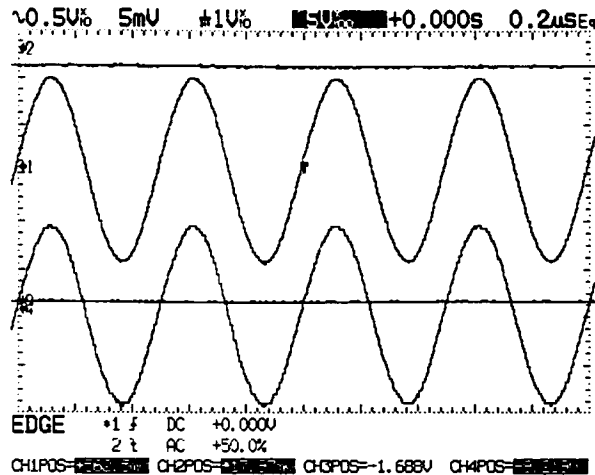

**Fig. 6-2 Example of vertical position read-out (moved after HOLD)**

### (5) Setting of probe factor

When adjusting the probe factor to the magnification of the used probe, the read-out on the screen and the measured value coincide with the measured voltage value.

If the probe factor is not adjusted to the magnification of the used probe, the reading from the screen must be converted using the magnification of the probe.

The setting menu for four channels is provided on page 1 of page menu.

For channel 1, set as follows.

CH1 PROBE: ×1      When a 1:1 probe is used or a signal is connected directly by a coaxial cable.

CH2 PROBE: ×10     When a 10:1 probe is used.

CH3 PROBE: ×100    When a 100:1 probe is used.

Set channels 2 thru 4(Channel 2 for the VC-7502) in the same way

### (6) Magnification of waveform

When the VOLT/DIV control is operated after holding a waveform, the waveform can be magnified vertically and displayed. This function is convenient to magnify the change of a small signal.

(A hold waveform cannot be compressed.)

## 6.4 Selection of acquisition mode (MODE)

< 512W acquisition and 8kW,  
2MW(VC-7524 only) acquisition >

- Outline** This instrument has a memory capacity of 8kW/CH (2MW/CH for the VC-7524) and the following three kinds (5 kinds for the VC-7524) of operations are available by selecting acquisition mode.
- NORMAL mode:** This instrument works as an instrument having a memory capacity of 512W/CH. Principally, it is impossible to see the other 7.5kW portion of the memory. In this mode, the highest refresh speed of the displayed waveform is available. This mode is useful to observe the fast changing component (AM or FM modulation) included on a signal.
- HIGH DENSITY mode :** In this mode, the data of 8kW/CH is sampled realtime. The data of 8kW/CH is acquired continuously at one sampling and the data of 8kW is all displayed on the screen. This mode is useful for the waveform analysis and detailed observation of a single shot phenomenon. It takes more time than the other mode to refresh a waveform, because data of large capacity is acquired and displayed.
- PILE mode:** A displayed waveform is configured by the data of 8kW/CH. However, 8kW data is not acquired at one shot. Data of 512W is acquired at a time. This data is overwritten in 16 phases to configure one waveform. The 16-phase data is updated in sequence from the phase acquired newly. In this mode, a waveform is not written completely until at least 16 times of phenomena (data update) occur. Therefore, the changing signals look as if waveforms are changing gradually. In other words, the persistence characteristic of the luminescent screen is observed. When an abnormal phenomenon occurs instantly for the steady-state signal, the abnormal phenomena are displayed in the form of discontinuity. In addition, it is left on the screen for a while. This means that the probability to find an abnormal phenomenon is high. Fig. 6-3 shows the examples that the amplitude lowered instantaneously due to slight change of the frequency of a signal generator is captured in this operation mode.

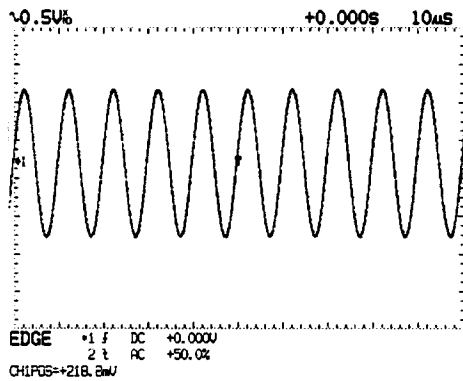

**(A) Normal output signal of signal generator**

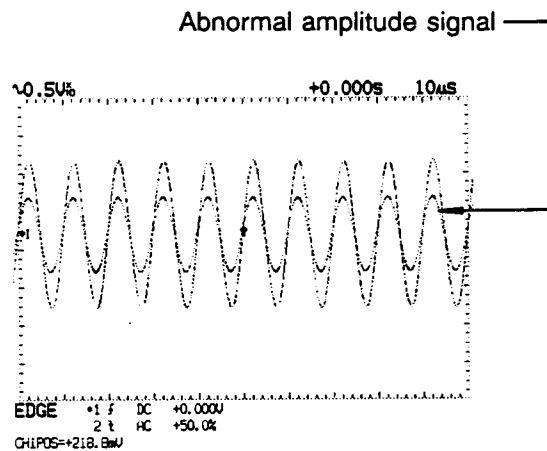

**(B) Abnormal signal with instantaneously small amplitude when a frequency is changed**

**Fig. 6-3 Examples of abnormal phenomena observed in PILE mode**

**PEAK/DETECT mode (VC-7502/04 only)**

The instrument operates as the equipment having the memory capacity of 1kw/CH. In this mode, maximum and minimum sampling values at the adjacent sampling intervals are acquired by 512w each and displayed. This mode is convenient to measure a signal containing glitches.

When the time range is set to the range that the equivalent sampling is available, the same operation as the NORMAL mode is available. (PEAK DETECT operation is not available.)

**ENVELOPE mode:**

The instrument operates as the equipment having the memory capacity of 1kw/CH. In this mode, the maximum and minimum sampling values over triggers of many times are acquired by 512w each and displayed.

This mode is convenient to measure the change of a waveform for each trigger. In this mode, the accumulation time of data can be specified.

The maximum and minimum values at each point are obtained and displayed on the screen by comparing the sampled value acquired for each trigger with the maximum and minimum sampled values acquired previously.

In the roll mode, the same operation as the PEAK DETECT mode (VC-7502/04) or as the NORMAL mode (VC-7524) is available.

(VC-7502/04 only)

In the ENVELOPE mode, the PEAK DETECT function works each trigger.

**LONG mode: (VC-7524 only)**

The data of up to 2MW/CH are continuously sampled in real time at are sampling. The sampled data is compressed horizontally to 1kW and displayed on the screen. Therefore, this mode is effective for the analysis and detailed measurements of single shot phenomena. The refreshing time is longer than the other models, because large capacity data are acquired and displayed.

**SPLIT mode: (VC-7524 only)**

The data of up to 512W/CH are sampled in real time. The waveform record memory is split up to 2000(512W/CH), and the single shot signal which occurs several times is acquired in sequence to the split record memories. The acquired data are

compressed horizontally to 1kW and displayed on the screen. However, the SPLIT operation is not available in the equivalent sampling mode or the roll mode.

In case of the SPLIT mode triggering, the number of split waveforms set based on the NORMAL trigger is acquired. In the AUTO trigger mode, only one-split waveform is displayed regardless of the number of split waveform set previously. Therefore, use this mode to check the voltage level setting, etc.

(Lates, the waveform data acquired at the memory length set for one trigger is expressed as one-split or one segment)

### Setting of the number of acquired data (VC-7524 only)

When the acquisition mode is LONG or SPLIT, the number of the data to be acquired can be set on the first row of page A of the page menu.

Example of waveform when the number of the acquired data is 512W/CH

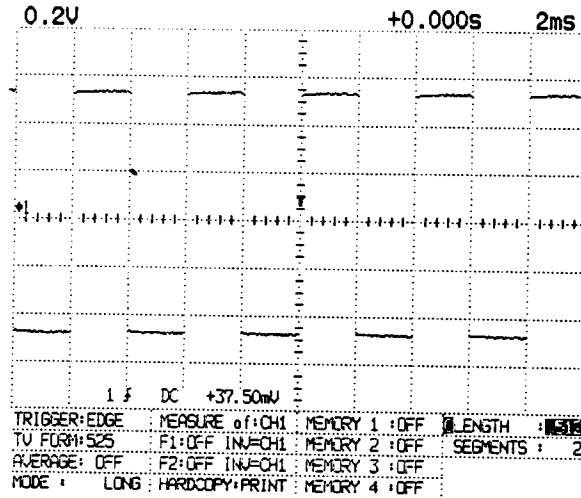

Example of waveform when the number of the acquired data is 2MW/CH

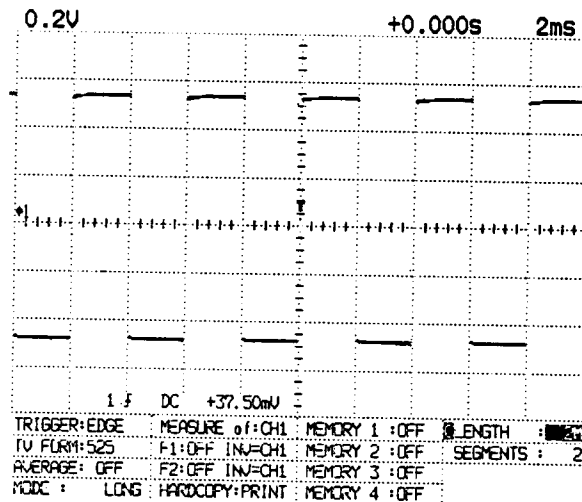

Selection of mode Use the fixed menu (4 lines, 1 column)  
mode

### Comparison of modes

	NORMAL	HIGH DENSITY	PILE	PEAK DETECT (only VC-7502/04)	ENVELOPE
No. of data acquired at one time	512W	8kW (*1)	512W(*2)	1kW	1kW (VC-7502/04) 512W (VC-7524)
No. of data of displayed waveform	512W	8kW	8kW	1kW	1kW
No. of event phases of displayed waveform	1	1(*1)	16(*2)	1	1
Tracking to change of signal	High speed	Low speed	Medium speed	Medium speed	Medium speed
Converging speed of waveform	High speed	Medium speed	Low speed	High speed	Low speed
Applications	Measurement on screen	Data analysis Detailed observation	Measurement of repetitive steady-state signal Check and capture of instantaneously abnormal phenomenon	Measurement of a signal containing glitches	Confirmation and capture of instantaneous abnormal events

	LONG(VC-7524only)							SPLIT(VC-7524 only)						
No. of data acquired at one time	(*3) 1M	(*3) 2M	(*3) 500k	(*3) 100k	(*3) 50k	(*3) 10k	1k	512	(*3) 500k	(*3) 100k	(*3) 50k	(*3) 10k	1k	512
No. of data of displayed waveform	1kW						512W	1kW						
No. of event phases of displayed waveform	1(*1)							(MAX) 2	(MAX) 10	(MAX) 20	(MAX) 100	(MAX) 1000	(MAX) 2000	
Tracking to change of signal	Low speed							Low speed						
Converging speed of waveform	Midle speed							Midle speed						
Applications	Data collection for long time Data analysis Detailed observation							Observation of repetitive normal signal Capture of instant abnormal phenomena						

- \*1) In case of the high speed range from 2ns/div to 20ns/div, the number of data acquired at a time is decreased and the number of event phases is increased.
- \*2) In case of the time axis range of 20mV/div or less and 0.2μs/div or higher, the number of data acquired at a time is increased. Accordingly, the number of event phases is decreased.
- \*3) In the high speed range of 2ns/div to 0.5ms/div the number of data acquired each time is decreased.(See next page.)

When the number of the acquired data is set to 1kW/CH or more in the LONG or SPLIT mode, the number of the acquired data is changed according to the set range. (VC-7524 only)

	1000s	0.1s	1ms	0.5ms	0.1ms	50μs	10μs	5μs	1μs	0.5μs	0.1μs	2ns
LENGTH												
2M	2M Roll (1000s-0.2s)	2M Real sample (1000s-2ms)	1M Real (1ms)	500k Real (0.5ms)	200k Real (0.2ms)	100k Real (0.1ms)	50k Real (50μs)	20k Real (20μs)	10k Real (10μs)	5k Real (5μs)	8k Equivalent sample (2μs-2ns)	
1M	1M Roll (1000s-0.2s)	1M Real sample (1000s-1ms)		500k Real (0.5ms)	200k Real (0.2ms)	100k Real (0.1ms)	50k Real (50μs)	20k Real (20μs)	10k Real (10μs)	5k Real (5μs)	8k Equivalent sample (2μs-2ns)	
500k	500k Roll (1000s-0.2s)	500k Real sample (1000s-0.5ms)			200k Real (0.2ms)	100k Real (0.1ms)	50k Real (50μs)	20k Real (20μs)	10k Real (10μs)	5k Real (5μs)	8k Equivalent sample (2μs-2ns)	
100k	100k Roll (1000s-0.2s)	100k Real sample (1000s-0.1ms)				50k Real (50μs)	20k Real (20μs)	10k Real (10μs)	5k Real (5μs)	8k Equivalent sample (2μs-2ns)		
50k	50k Roll (1000s-0.2s)	50k Real sample (1000s-50μs)					20k Real (20μs)	10k Real (10μs)	5k Real (5μs)	8k Equivalent sample (2μs-2ns)		
10k	10k Roll (1000s-0.2s)	10k Real sample (1000s-10μs)						5k Real (5μs)	8k Equivalent sample (2μs-2ns)			
1k	1k Roll (1000s-0.2s)	1k Real sample (1000s-1μs)							512 Real (0.5μs)	512 Equiv (0.2μs-2ns)		
512	512 Roll (1000s-0.2s)	512 Real sample (1000s-0.5μs)								512 Equiv (0.2μs-2ns)		

Relation ship between memory length, sampling modes and TIME/DIV

## 6.5 Operation of time axis

< Setting of time axis range and measurement of pre-trigger and post-trigger sections >

### (1) Setting of time axis range (TIME/DIV)

#### TIME/DIV



The time axis range is set by the TIME/DIV knob.

The high speed sweep range is selected by the clockwise rotation, and the low speed sweep range is selected by the counterclockwise rotation.

The read-out of the time axis range is displayed at the top right of the screen. Changing the TIME/DIV value changes the sampling modes. The change position of a sampling mode is changed by the setting of the acquisition mode.

When TIME/DIV is operated, a sampling rate is momentarily displayed below the time axis range setting value display.

**Fig. 6-5 Relationship between TIME/DIV and sampling modes**

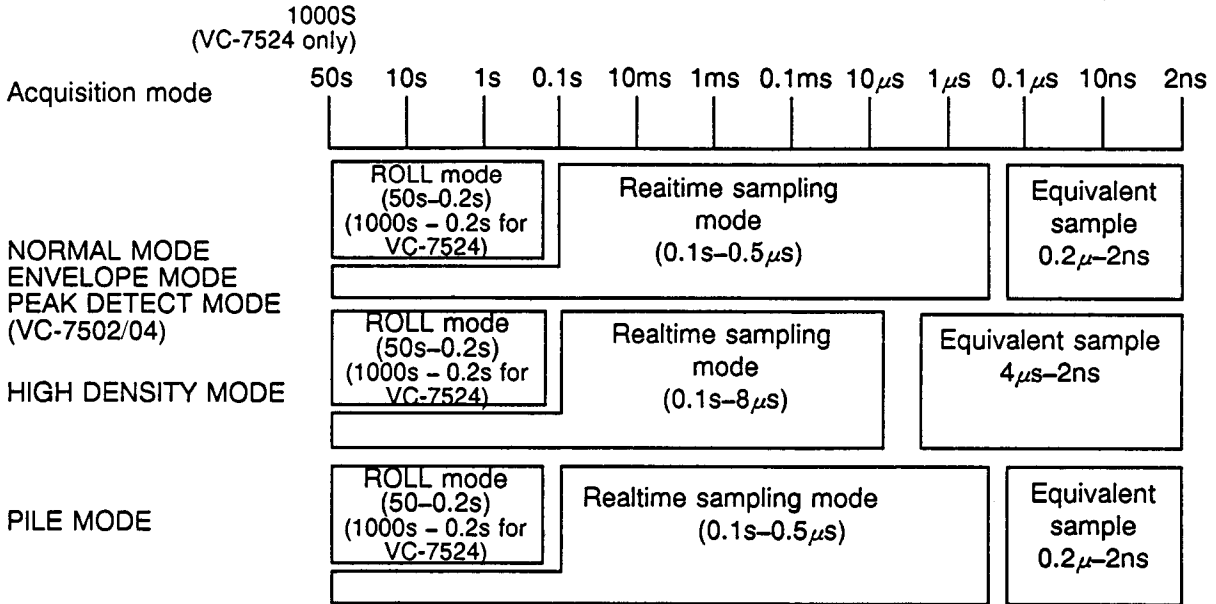

**Note:** 50s-0.2S(1000s - 0.2s for VC-7524)

When the AUTO (ROLL) NORM key of the TRIGGER section is set to AUTO (ROLL) (LED is lit), the ROLL mode is established. When the NORM is selected, realtime sampling is performed in this range. For the relationship between TIME/DIV and sampling modes in the LONG mode or the SPLIT mode (VC-7524 only), see previous page.

Acquisition mode \ Sampling mode	Roll mode (50-0.2s)	Realtime mode*1 (50-0.2s) (0.1s-1.0 $\mu$ s)	Equivalent mode
ENVELOPE mode	Glitch detection operation	Glitch detection	Glitch not detected
PEAK DETECT mode	Glitch detection operation	Glitch detection operation	Normal operation without glitch detection

**Fig. 6-5(C) Relationship between sampling modes and detection operation (VC-7502/04 only)**

\*1 : The instrument does not perform glitch detection operation at 0.5 $\mu$ s, and works as 512W/ch at 100Ms/s.

**(A) Realtime sampling mode**

In this mode, an input signal is continuously sampled, and both single shot waveform and repetitive waveform can be stored.

A sampling speed is changed for each time range.

The maximum frequency bandwidth of the input signal in this mode is 25MHz.

**Table 6-3 Relationship between sweep time and sampling frequency of each mode**

Sweep time	Sampling frequency $f_s$ (S/s)		
	NORMAL	HIGH DENSITY	PILE (*1)
0.5 $\mu$ s	100M	—	100M
1 $\mu$ s	50M	—	50M
2 $\mu$ s	25M	—	25M
4 $\mu$ s	—	—	—
5 $\mu$ s	10M	—	10M
8 $\mu$ s	—	100M	—
10 $\mu$ s	5M	80M	5M
20 $\mu$ s	2.5M	40M	2.5M
50 $\mu$ s	1M	16M	1M
0.1ms	500k	8M	500k
0.2ms	250k	4M	250k
0.5ms	100k	1.6M	100k
1ms	50k	800k	50k
2ms	25k	400k	25k
5ms	10k	160k	10k
10ms	5k	80k	5k
20ms	2.5k	40k	5k
50ms	1k	16k	4k
0.1s	500	8k	4k
0.2s	250	4k	4k
0.5s	100	1.6k	1.6k
1s	50	800	800
2s	25	400	400
5s	10	160	160
10s	5	80	80
20s	2.5	40	40
50s	1	16	16
100s(VC-7524 only)	0.5	8	8
200s(VC-7524 only)	0.25	4	4
500s(VC-7524 only)	0.1	1.6	1.6
1000s(VC-7524 only)	0.05	0.8	0.8

\*1) The sampling frequencies of the data acquired once and displayed are listed.



**Tble 6-3 Relationship between sweep time and sampling frequency of each mode(Continued)**

Sweep time	Sampling frequency fs (S/s)							
	LONG/SPLIT(VC-7524 only)							
	512w	1kw	10kw	50kw	100kw	500kw	1Mw (LONG only)	2Mw (LONG only)
0.5 $\mu$ s	100M	—	—	—	—	—	—	—
1 $\mu$ s	50M	100M	—	—	—	—	—	—
2 $\mu$ s	25M	50M	—	—	—	—	—	—
4 $\mu$ s	—	—	—	—	—	—	—	—
5 $\mu$ s	10M	20M	—	—	—	—	—	—
8 $\mu$ s	—	—	—	—	—	—	—	—
10 $\mu$ s	5M	10M	100M	—	—	—	—	—
20 $\mu$ s	2.5M	5M	50M	—	—	—	—	—
50 $\mu$ s	1M	2M	20M	100M	—	—	—	—
0.1ms	500k	1M	10M	50M	100M	—	—	—
0.2ms	250k	500k	5M	25M	50M	—	—	—
0.5ms	100k	200k	2M	10M	20M	100M	—	—
1ms	50k	100k	1M	5M	10M	50M	100M	—
2ms	25k	50k	500k	2.5M	5M	25M	50M	100M
5ms	10k	20k	200k	1M	2M	10M	20M	40M
10ms	5k	10k	100k	500k	1M	5M	10M	20M
20ms	2.5k	5k	50k	250k	500k	2.5M	5M	10M
50ms	1k	2k	20k	100k	200k	1M	2M	4M
0.1s	500	1k	10k	50k	100k	500k	1M	2M
0.2s	250	500	5k	25k	50k	250k	500k	1M
0.5s	100	200	2k	10k	20k	100k	200k	400k
1s	50	100	1K	5k	10k	50k	100k	200k
2s	25	50	500	2.5k	5k	25k	50k	100k
5s	10	20	200	1k	2k	10k	20k	40k
10s	5	10	100	500	1k	5k	10k	20k
20s	2.5	5	50	250	500	2.5k	5k	10k
50s	1	2	20	100	200	1k	2k	4k
100s (VC-7524 only)	0.5	1	10	50	100	500	1k	2k
200s (VC-7524 only)	0.25	0.5	5	25	50	250	500	1k
500s (VC-7524 only)	0.1	0.2	2	10	20	100	200	400
1000s (VC-7524 only)	0.05	0.1	1	5	10	50	100	200

## **(B) Equivalent sampling mode (EQUIVALENT)**

In this mode, sampling is performed several times by using the repetitiveness of an input signal and the sampled waveforms are composed to produce one waveform.

In this mode, only the repetitive waveform can be stored. (This mode is not used for a single shot signal.)

Because of the above characteristics, it takes some time to converge waveforms when the signal of a low frequency is observed.

## **(C) ROLL mode**

In this mode, a waveform is displayed flowing from right to left on the screen.

The right edge of a trace becomes the update point of a new data, and the newly sampled data are added.

This mode is useful to measure a signal of approximately 100Hz or less.

To stop the ROLL mode and fix the final waveform on the screen, press the HOLD/SINGLE key.

The SINGLE sweep cannot be selected in the ROLL mode.

### **Note: Aliasing**

When an input signal having the frequency of more than half of the sampling frequency in the sweep range is applied, aliasing can occur.

In this case, the waveform (input signal frequency minus sample clock frequency) is displayed and this display can be judged to represent a correct input signal. Such a waveform as aliasing is occurring represents following nature.

If these phenomena are observed, check the waveform carefully.

- Though trigger setting is performed properly, the waveform is not seen as triggered.
- When a sweep range is changed to a faster range, the waveform is not seen as magnified horizontally and it is disordered.

To check the waveform more accurately, select the HIGH DENSITY mode and set to the same range. Then, check if the same waveform is displayed.

## **(2) Delay setting (DELAY) and reset of setting amount (SET TO Os)**

### **DELAY**



A trigger position can be moved horizontally by the DELAY knob. When the DELAY knob is set to zero, the trigger position is displayed at the horizontal center of the screen.

When the DELAY knob is turned clockwise to move the trigger position to the right side, the waveform after trigger (post-trigger section) can be observed.

Though the range where the post-trigger is observed is changed according to the selected time axis range, the maximum range is 500DIV.

The read-out of the set DELAY time is displayed at the left side of the TIME/DIV display on the screen. This display indicates the center position of the screen with respect to the trigger point in term of the time.

When the fast sweep range is set by the TIME/DIV knob with the delay time set appropriately, the portion delayed from the trigger by the set delay time can be observed more accurately.

### **In case of VC-7524**

When the acquisition mode is set to other than SPLIT and the H MODE is set to ALT or B, delay setting for magnified waveform is performed.

When the acquisition mode is set to SPLIT and the H MODE is set to ALT, the desired

split portion of the original waveform to be selected and magnified can be set. When the H MODE is set to B, the delay of the magnified waveform is set. (When the acquisition mode is set to SPLIT and the H MODE is set to A, delay is fixed.)

**SET TO 0s**



To clear the set delay amount to zero, press the SET TO 0s key.

When the acquisition mode is set to SPLIT and the H MODE is set to ALT (VC-7524 only), the first split data is magnified by pressing the SET TO 0S key.

**(3) Horizontal magnification and movement**

The horizontal magnification of a waveform is made by setting H MODE to ALT or B. In this case, the time axis range of the magnified waveform is displayed in inverse video.

① When the acquisition mode is LONG (In case of VC-7524)

(a) A

The number of the acquired data selected by LENGTH at the first row of page A of the page menu are compressed horizontally to 1kW/CH and displayed on the screen.

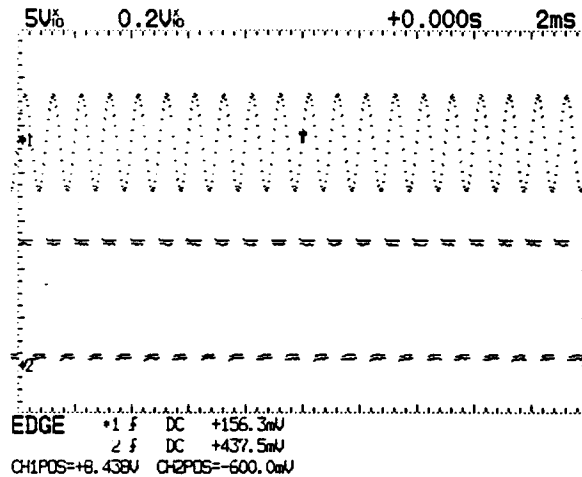

(b) ALT

The original waveforms which all the acquired data are compressed horizontally to 1kW/CH, and a part of the original waveforms which are magnified are displayed simultaneously. The magnified position is indicated on the original waveforms by the vertical cursor. Horizontal magnification is performed according to the TIME/DIV setting. The magnified waveform can be shifted horizontally by the DELAY control. Though the magnification ratio is subject to change by the number of the acquired data, the data can be magnified until the sampled data which is not compressed is displayed as is. (more magnification can be done.)

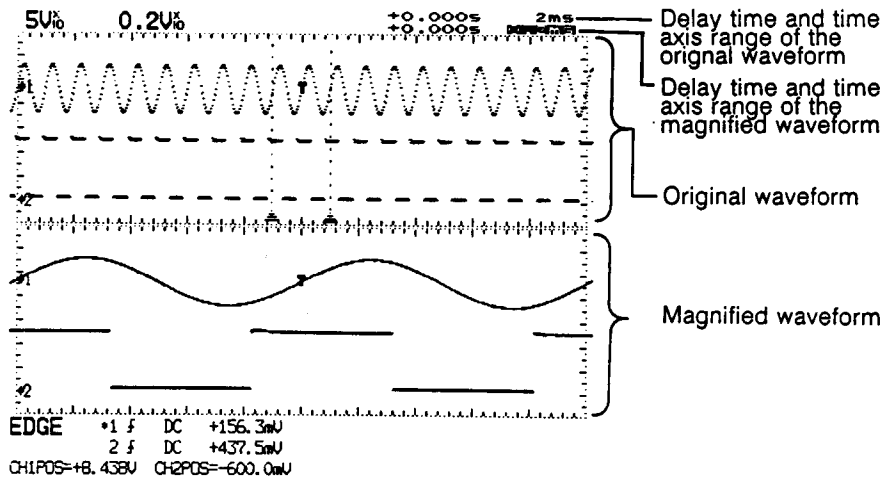

(c) B

The waveform magnified horizontally is displayed on the screen.

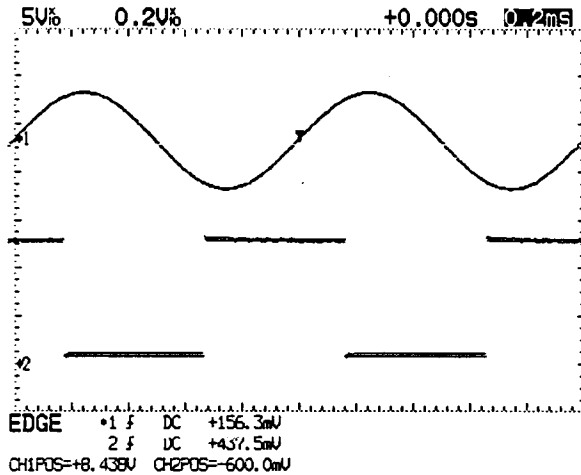

② When the acquisition mode is NORM, HI DENSE, ENVELOPE, PEAK DETECT (VC-7502/04) or PILE, take the same operating procedure as in the LONG mode.  
The maximum magnification ratio of a waveform is 100 times.

③ When the acquisition mode is SPLIT (In case of VC-7524)

(a) A

Sampling and split data are compressed horizontally to 1kW/CH and displayed on the screen

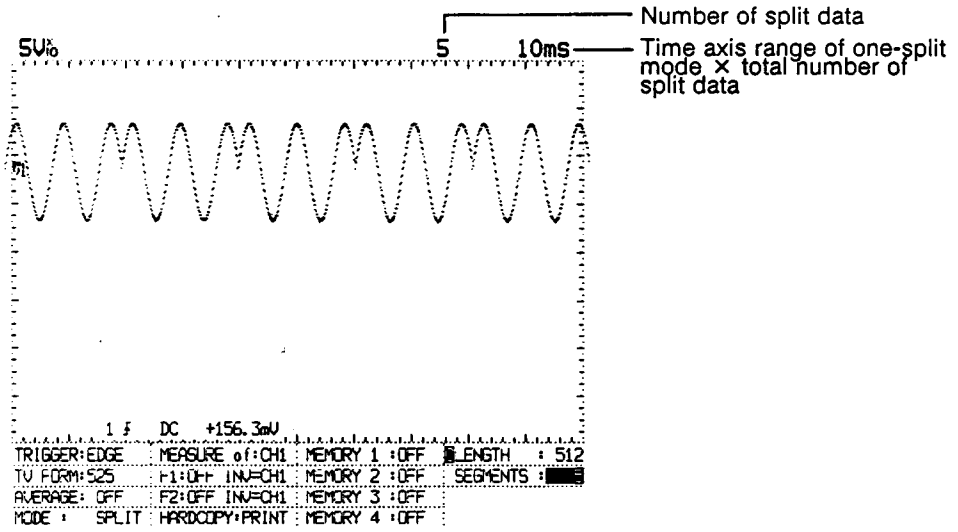

(b) ALT

The original waveform which all split data are compressed horizontally to 1kW/CH and the specified split data are displayed on the screen. The number of the magnified split data is displayed at the upper part of the screen by the vertical cursor. The split data of a different number can be displayed by the DELAY control.

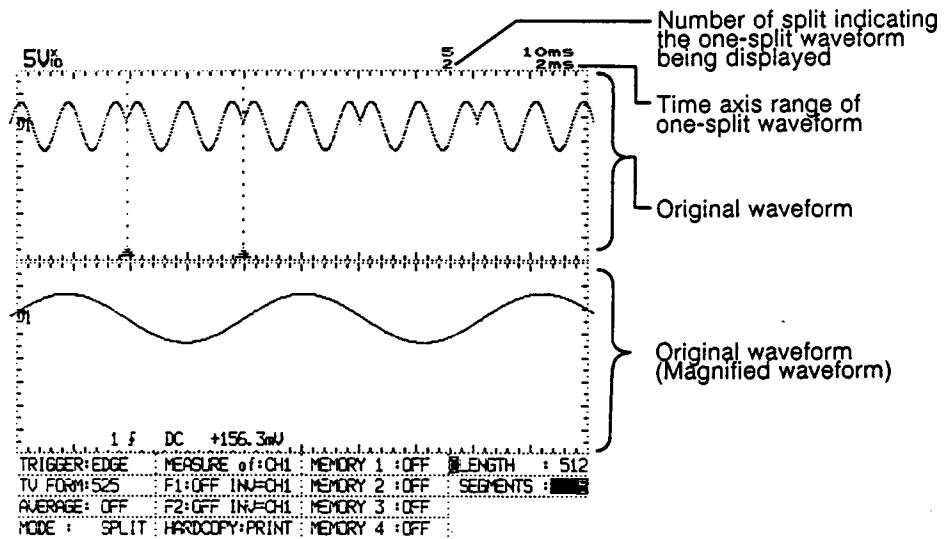

(c) B

One-split waveform is magnified horizontally and displayed on the screen.  
The number of the displayed split data is displayed at the upper part of the screen.  
When the TIME/DIV control is set to a high speed range, the waveform is magnified horizontally according to the TIME/DIV setting. The magnified waveform can be shifted horizontally by the DELAY control.

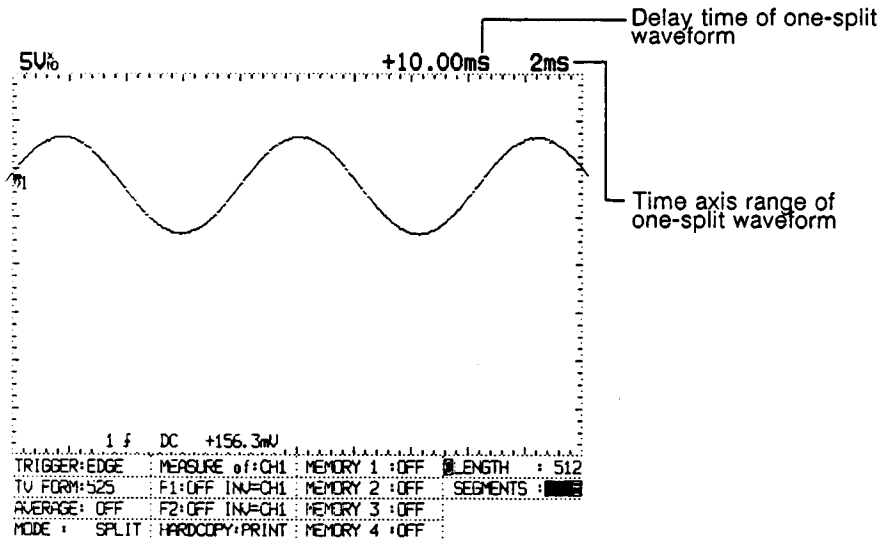

**(4) Selection of interpolation modes at the time of horizontal magnification.**

When a waveform is magnified horizontally interpolation is performed when sampled waveforms become absent between displayed dots. Thus, the magnified waveform is easily observed.

Two interpolation algorithms, the SIN, linear and OFF (VC-7124 only) interpolation modes, are available using the fourth line on page A of the page menu.

The SIN interpolation is convenient for a SIN waveform, and the linear interpolation is convenient for a pulse waveform.

**(5) Switching of magnified waveform display**

The single or dual display mode can be selected on the second row of page 9 of the page menu.

①When the acquisition mode is NORM, LONG(VC-7524), HI DENSE, ENVELOPE, PEAK DETECT (VC-7502/04) or PILE

**(a) Single display**

The magnified waveform of one section is displayed.

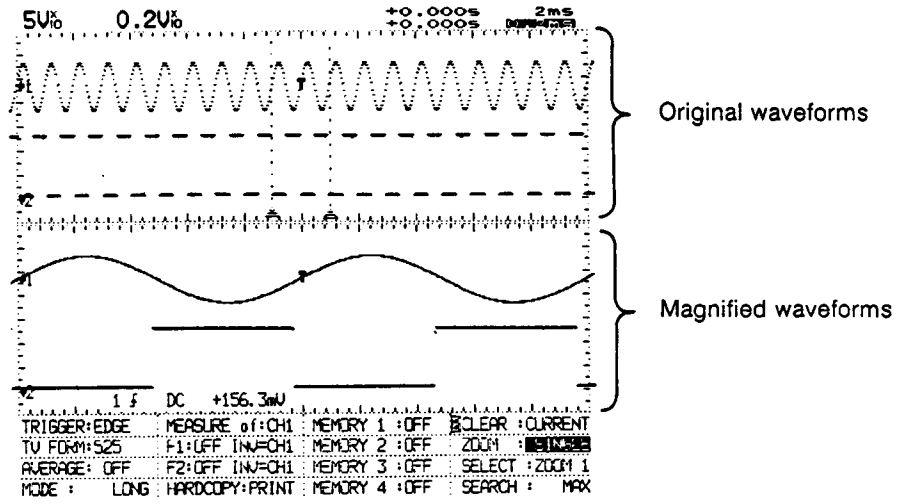

**(b) Dual display**

The magnified waveforms of two sections can be displayed at the same time.

Both magnified waveforms can be shifted horizontally by the TIME/DIV control. When the SELECT is set to ZOOM1, the magnified waveform 1 can be moved in the horizontal direction by the DELAY control.

When the SELECT is set to ZOOM2, the magnified waveform 2 can be moved in the horizontal direction by the DELAY control.

- When H MODE is ALT, the original waveforms and the magnified waveforms 1 and 2 are displayed.

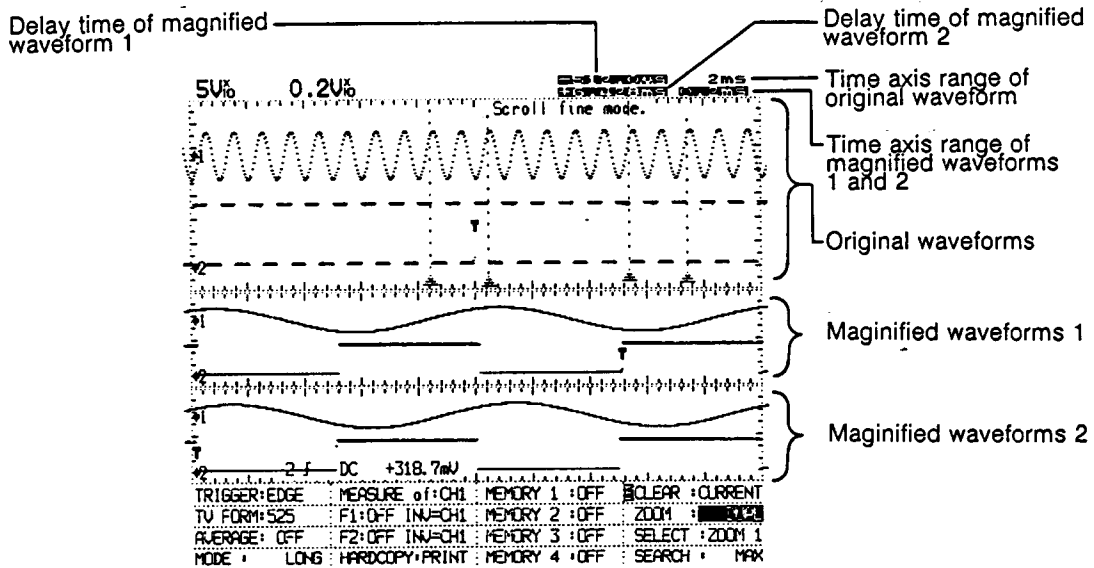

- When the H MODE is set to B, the magnified waveforms 1 and 2 are displayed.

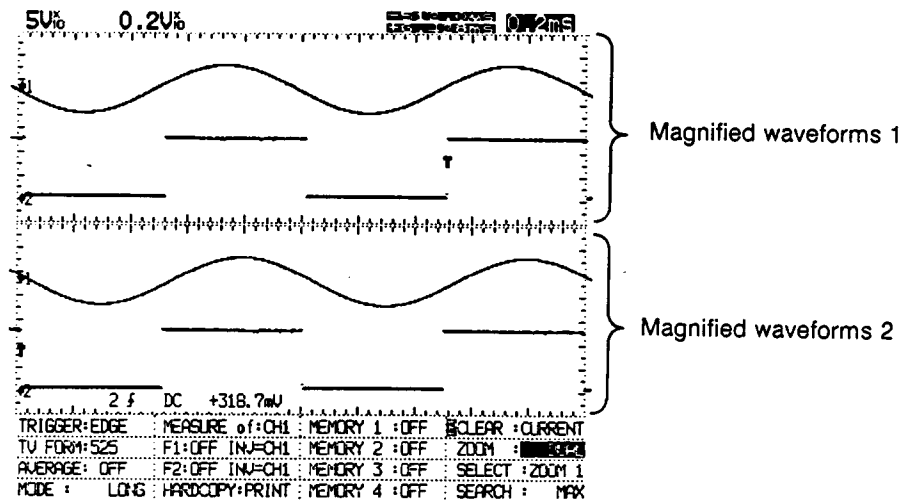

② When the acquisition mode is SPLIT (only VC-7524)

**(a) Single display**

One-split waveform at one place is displayed.

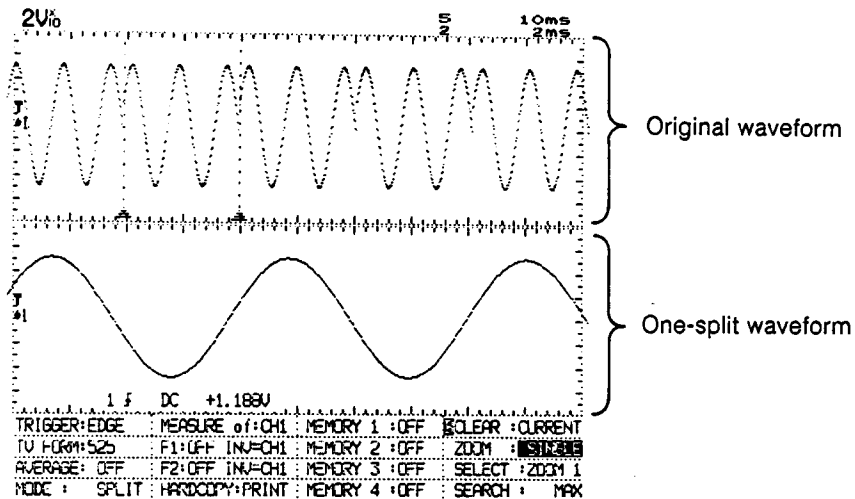

**(b) Dual display**

One-split waveforms at two places are displayed.

- When the H MODE is set to ALT, the original waveform and the one-split waveforms 1 and 2 are displayed.

When the SELECT is set to ZOOM1, one-split waveform having the different split number from one-split waveform 1, by the DELAY control.

When the SELECT is set to ZOOM2, one-split waveform having the different split number from one-split waveform 2, by the DELAY control.



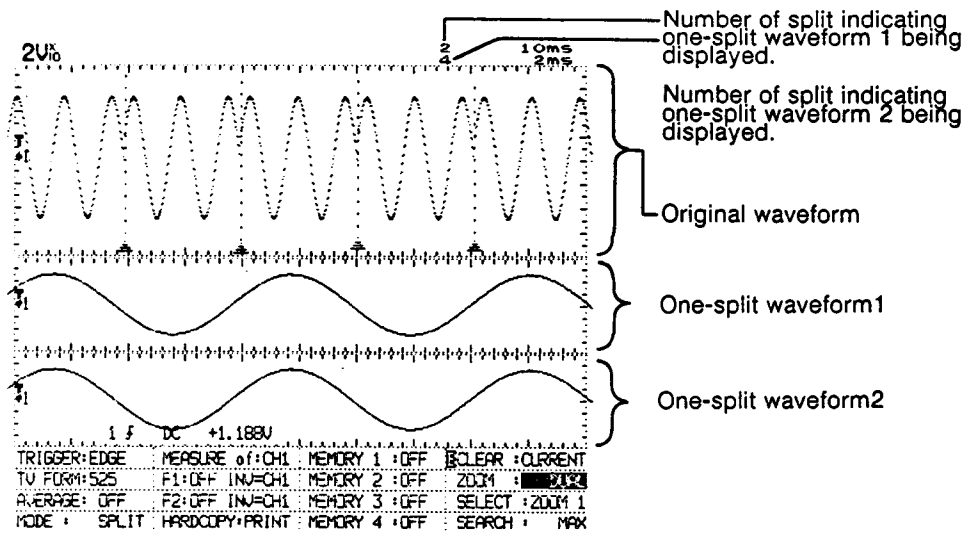

- When the H MODE is set to B, one-split waveforms 1 and 2 are displayed.

When the SELECT is set to ZOOM1, one-split waveform 1 can be moved horizontally by the DELAY control.

When the SELECT is set to ZOOM2, one-split waveform 2 can be moved horizontally by the DELAY control.

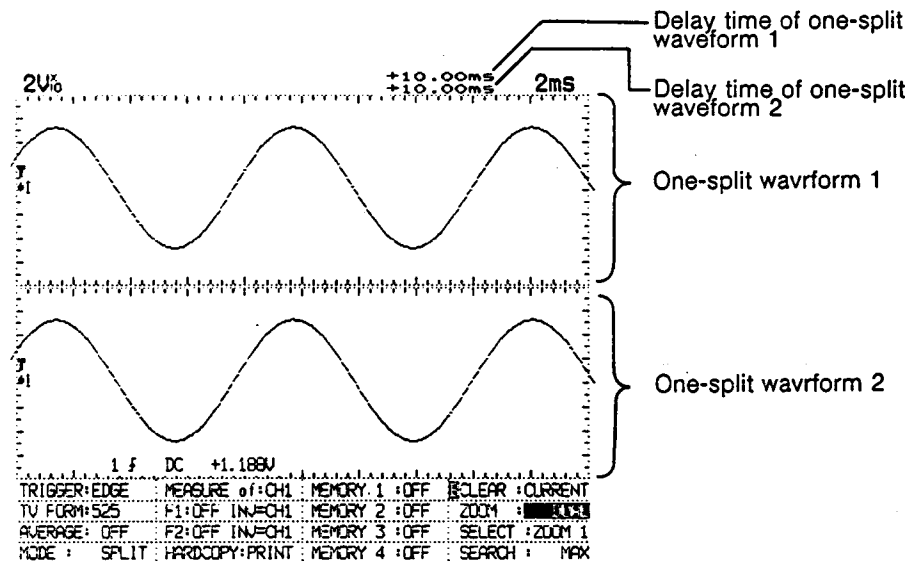

## 6.6 Operation of trigger function

In addition to the most popular edge trigger function, this instrument has various trigger functions including the delay trigger, event trigger, window trigger and TV line select trigger. Further, this instrument has the trigger setup function.

With this function, two sets of trigger setup conditions can be switched when the edge trigger function is selected. While the menu is being displayed, the setting value selected by the SELECT key is displayed at the bottom left of the scale.

### 6.6.1 Edge trigger function (EDGE) < Most popular trigger function- Edge trigger >

This function provides a trigger level to a trigger source signal and applies trigger at the trigger level.

#### Selection of edge trigger

Select by the fixed menu (1 line, 1 column)  
Select TRIGGER EDGE.

#### Setting method

Allow the menu to disappear and select the waveform observation screen.

#### SELECT

○ 1st/2nd



Select 1st by this key (LED is lit).

For the use of this key, refer to section 6.6.2.

In this case, the trigger setup selection mark (\*) is displayed at the upper portion of the trigger setting read-out.

Fig. 6-7 shows the example of the screen when the EDGE trigger is selected.

As described in section 5.1 (6), the trigger settings are displayed on this screen as follows.

Trigger source: CH1  
Slope: Rising edge  
Trigger coupling: DC

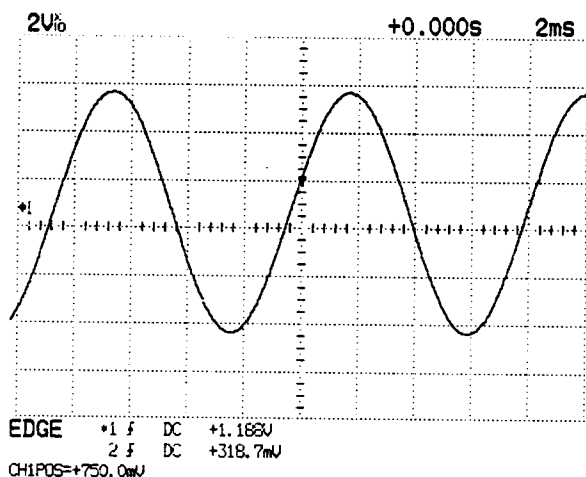

Fig. 6-7 Example of screen in EDGE trigger mode

**SOURCE**

Select the channel of a signal to be used as a trigger source.

CH1, CH2, CH3 and CH4 are available for the VC-7524/VC-7504.

CH1, CH2, EXT and EXT ÷ 10 are available for the VC-7502.

**SLOPE**

Select a rising edge or falling edge.

**COUPLING**

Select a coupling type between a trigger source signal and a trigger circuit.

DC: A trigger signal containing a DC component is coupled. Trigger is applied when the DC level of the signal crosses the trigger level.

AC: The DC component of a trigger signal is cut and only the AC component is coupled. The cut-off frequency is 10Hz.

H Frej: The high frequency component of a trigger signal is cut and coupled. The cut-off frequency is approx. 50kHz.

L Frej: The low frequency component of a trigger signal is cut and coupled. The cut-off frequency is approx. 50kHz.

Select the AUTO trigger mode or the NORM trigger mode.

AUTO  
(ROLL)  
/NORM

AUTO: When a signal is triggered, the screen is updated by each trigger signal.

When no signal is connected or trigger is un locked, the screen is automatically updated.

When the TIME/DIV switch is set to 0.2s or less, the ROLL mode is established.

NORM: The waveform on the screen is updated only when a signal is triggered.

When no signal is connected or trigger is unlocked, the screen is not updated until trigger is applied. Use this mode to apply trigger to a very low frequency signal (30Hz or less) or to measure a single shot signal.

**LEVEL**



Apply trigger by matching the level of a trigger signal to the trigger level.

**DC or HFrej COUPLING**

The T-shape mark is displayed. As the vertical level of this mark indicates the trigger level, match this level to the signal. In this case, the read-out of the trigger level indicates the voltage with respect to the GND level of trigger source signal.

**AC or LFrej COUPLING**

In this case, the T-shape mark is not displayed.

The read-out of the trigger level is displayed in the units of %.

The trigger level setting range is approx. 8DIV with respect to the horizontal center of the screen. This range is displayed by 0 to 100%. In other words, the horizontal center of the screen is 50%. Approx. 8DIV below the horizontal center line is 0% and approx. 8DIV above the horizontal center line is 100%.

## 6.6.2 Trigger setup function <Two sets of setup of edge trigger are selectable.>

**Functional description** When the edge trigger function is selected, two sets of trigger setup conditions can be selected from SOURCE, SLOPE, COUPLING and LEVEL. This is convenient to check the timings of two signals by applying triggers to the two signals alternately.

**Setting of trigger setup conditions**

**SELECT**

○1st/2nd

### ① Setting of 1st trigger

Select 1st by this key. (LED is lit.)

The trigger setup selection mark (\*) is displayed at the upper portion of the trigger setup read-out.

Set SOURCE, SLOPE, COUPLING and LEVEL appropriately according to section 6.6.1.

The set information is displayed at the 1st trigger display portion.

### ② Setting of 2nd trigger

Select 2nd by this key. (LED goes out.)

The trigger setup selection mark (\*) is displayed at the lower portion of the trigger setting read-out.

Set SOURCE, SLOPE, COUPLING and LEVEL to the respective values different from the setting ① above.

The set information is displayed at the 2nd trigger display portion.

The setting procedure is now over. Each pressing the SELECT key recalls the setting contents ① and ② alternately.

**SELECT**

○1st/2nd

## 6.6.3 Delay trigger function (DELAY) <Capture of phenomenon caused after a given time>

**Functional description** After the 1st trigger has been applied, the true trigger is applied by the 2nd trigger after elapse of the set time.

This function can be used to check the phenomenon caused first after the elapse of a given time after a control signal (called a 1st trigger) has been generated in a control system using a microprocessor.

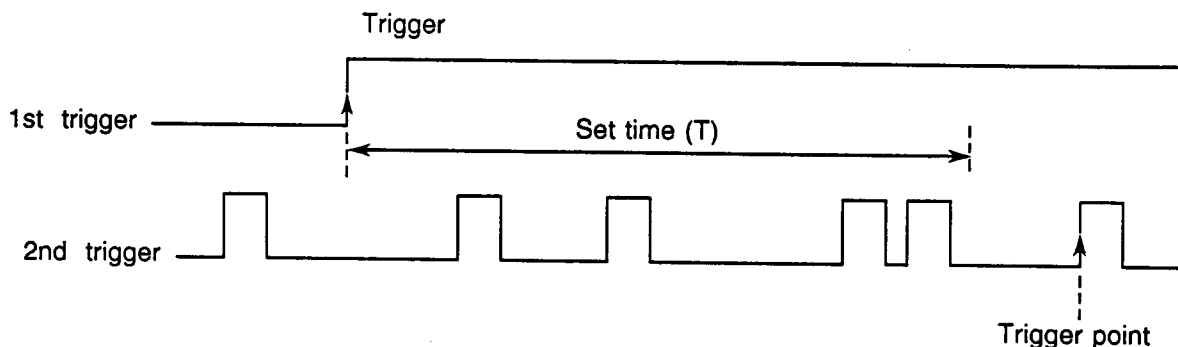

The 2nd trigger signal is ignored during the set time interval (T).

The 2nd trigger signal caused first after elapse of the set time (T) becomes a trigger point.

**Fig.6-8 Explanatory figure of delay trigger operation**

## Operation

- ① Select the EDGE trigger mode and set so that the 1st signal is triggered by the 1st trigger setup conditions. Also, set so that the 2nd signal is triggered by the 2nd trigger setup conditions.
- ② Select the DELAY trigger mode by the fixed menu (1 line, 1 column)  
TRIGGER: DELAY
- ③ The menu screen disappears and the read-out of the DELAY trigger setup is displayed.

An example of the waveform measured in the DELAY trigger mode is shown in Fig. 6-9.

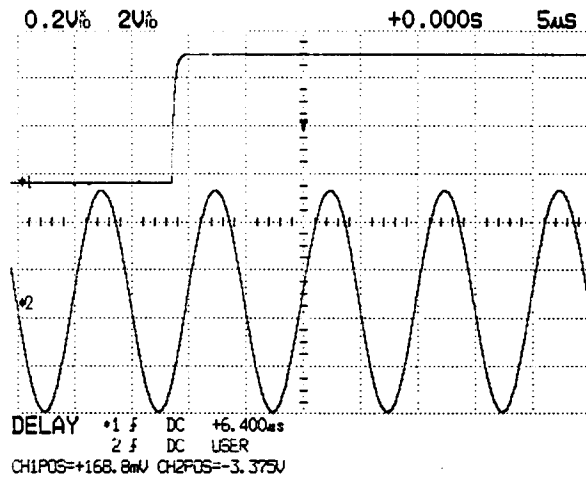

Fig. 6-9

## LEVEL



This mode plays a role different from the EDGE trigger mode.

- When the 1st trigger is selected

The DELAY time can be set by the LEVEL knob.

- When the 2nd trigger is selected

This knob can be used to select the trigger levels of the two signals from the following three levels.

USER: The levels set in the EDGE trigger mode are set to the 1st and 2nd signals.

TTL: This is the mode for the TTL signal measurement and both signal 1 and signal 2 are set to +1.6V.

ECL: This is the mode for the ECL signal measurement and both signal 1 and signal 2 are set to -1.3V.

**Note:** It is impossible to change the level of the 1st trigger and the USER level of the 2nd trigger in the DELAY trigger mode. To change them, establish the EDGE trigger mode.

## ○AUTO(ROLL) )/NORM



**AUTO:** Though the trigger signal is generated when trigger is applied by the 1st signal, the 1st trigger is automatically generated when the 1st signal trigger is unlocked or when a signal is absent.

This function is invalid for the 2nd signal (2nd trigger side).

When the TIME/DIV is set to 0.2s or less, the ROLL mode is established.

**NORM:** The 1st trigger is generated only when trigger is applied by the 1st signal.

Use this mode when the 1st signal is a very low frequency signal (30Hz or less).

**Note:** Use this trigger mode when trigger is applied by the 2nd signal.

When trigger is not applied by the 2nd signal, the screen is not updated even in the AUTO trigger mode.

Other key operations of SOURCE, SLOPE and COUPLING are the same as those in the EDGE trigger mode, and their keys can be set similarly in the DELAY trigger mode.

#### 6.6.4 Window trigger function < Capture of both positive and negative signals >

**Functional description** Two trigger levels can be set on the screen.  
Trigger can be applied when the trigger signal goes out of the range of the two levels or when it goes into the range.

**Operation**

- ① Select the WINDOW trigger mode by the fixed menu (1 line, 1 column).  
TRIGGER: WINDOW
- ② The menu screen disappears and the read-outs of the WINDOW trigger setup are displayed.  
The example of the waveform measured in the WINDOW trigger mode is shown in Fig. 6-10.

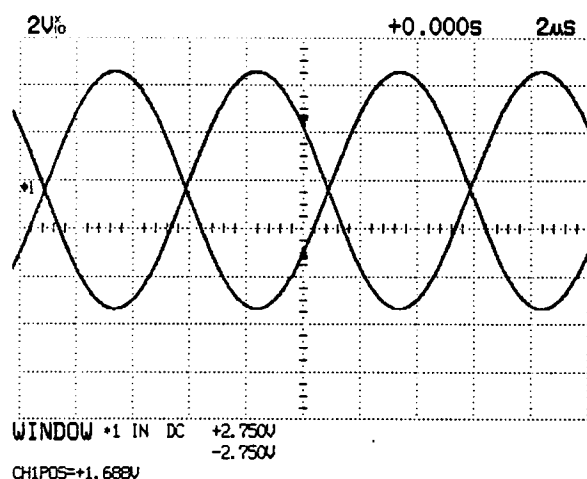

Fig. 6-10

#### LEVEL



In this operation mode, the window width of trigger can be set.

- When the 1st trigger is selected  
Set the upper level (  $\top$  ) of the window.
- When the 2nd trigger is selected  
Set the lower level (  $\perp$  ) of the window.

#### SLOPE



In this mode set IN and OUT.

- IN : Trigger is applied when an input signal goes to the inside of the window from the outside.
- OUT: Trigger is applied when an input signal goes out from the inside of the window.

Other key operations of SOURCE and COUPLING are the same as those in the trigger mode, and the key settings can be made similarly in the WINDOW mode.

### 6.6.5 Event trigger function < Application of trigger by the number of phenomena occurred >

**Functional description** The number of times of the 2nd trigger input is counted from the time when the 1st trigger is applied, and trigger is applied when the number of counted times reaches the set value (2 thru 4097).

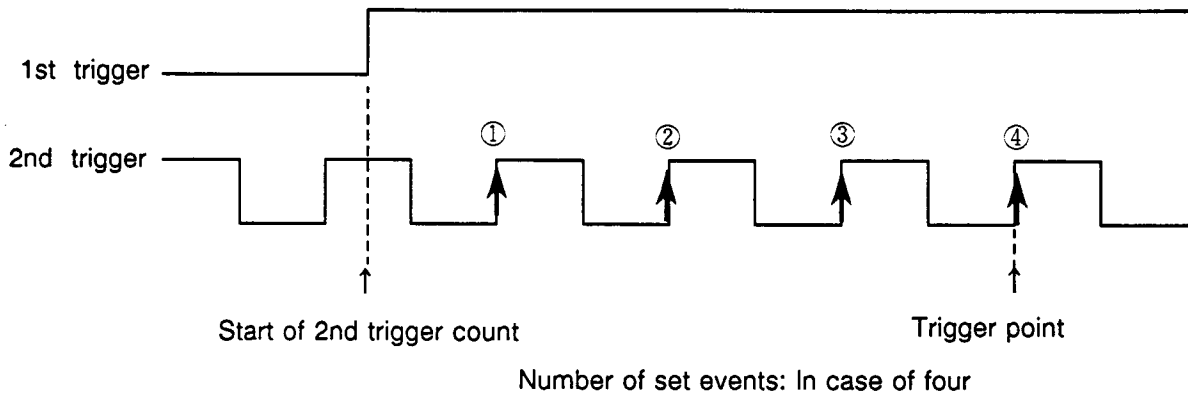

**Fig. 6-11 Explanatory figure of event**

**Operation**

- ① Set the EDGE trigger mode first. Then, set so that the 1st signal is triggered by the 1st trigger setup. Also, set so that the 2nd signal is triggered by the 2nd trigger setup.
- ② Select the EVENT trigger mode by the fixed menu (1 line, 1 column).  
TRIGGER: EVENT
- ③ The menu screen disappears and the read-outs of the EVENT trigger setup are displayed.  
An example of the waveform measured in the EVENT trigger mode is shown in Fig. 6- 12.

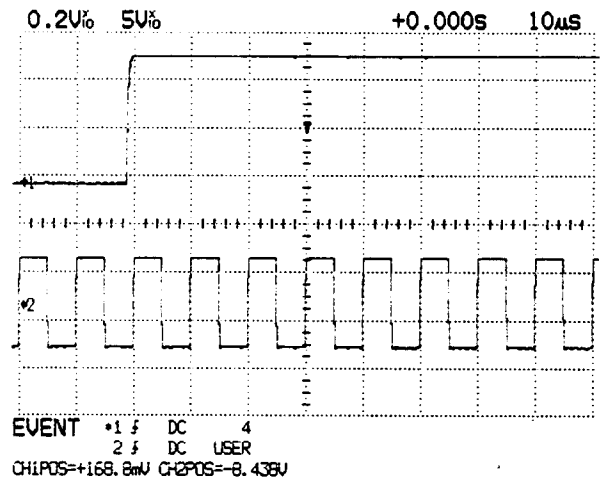

**Fig. 6-12**

## LEVEL



- When the 1st trigger is selected  
The number of events can be set by the LEVEL knob.
- When the 2nd trigger is selected.  
This knob can be used to select the trigger levels of the two signals from the following three levels.

USER: The levels set in the EDGE trigger mode are set to the 1st and 2nd signals.

TTL: This is the mode for the TTL signal measurement and both signal and signal 2 are set to +1.6V.

ECL: This is the mode for the ECL signal measurement and both signal 1 and signal 2 are set to -1.3V.

**Note:** It is impossible to change the level of the 1st trigger and the USER level of the 2nd trigger in the DELAY trigger mode. To change them, establish the EDGE trigger mode.

## AUTO(ROLL)/

### NORM



**AUTO:** Though the trigger signal is generated when trigger is applied by the 1st signal, the 1st trigger is automatically generated when the 1st signal trigger is unlocked or when a signal is absent.

This function is invalid for the 2nd signal (2nd trigger side).

When the TIME/DIV is set to 0.2s or less, the ROLL mode is established.

**NORM:** The 1st trigger is generated only when trigger is applied by the 1st signal.

Use this mode when the 1st signal is a very low frequency signal (30Hz or less).

**Note:** Use this trigger mode when trigger is applied by the 2nd signal.

When trigger is not applied by the 2nd signal, the screen is not updated even in the AUTO trigger mode.

Other key operations of SOURCE, SLOPE and COUPLING are the same as those in the EDGE trigger mode, and their keys can be set similarly in the DELAY trigger mode.

## Caution

- ① The dead time of approximately 40ns is needed until start of the 2nd trigger count after the 1st trigger.

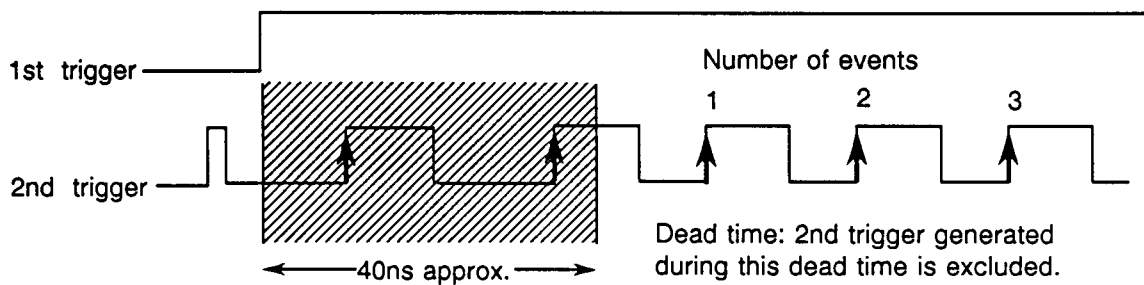

Fig. 6-13

- ② The maximum input frequency of the 2nd trigger is 30MHz.



## 6.6.6 TV trigger function < Trigger when TV signal is measured >

<b>Functional description</b>	The following three TV trigger modes are available to measure a TV signal. TV-V: Triggered by a vertical sync signal. TV-H: Triggered by a horizontal sync signal. TVLINE: Triggered by specifying an arbitrary scanning line.
-------------------------------	---

### Operation (1) TV-V trigger mode

- ① Select the TV-V trigger mode by the fixed menu (1 line, 1 column).  
TRIGGER: TV-V
- ② The menu screen disappears and the read-outs of the TV-V trigger setup are displayed.  
An example of the waveform measured in the TV-V trigger mode is shown in Fig. 6-14.

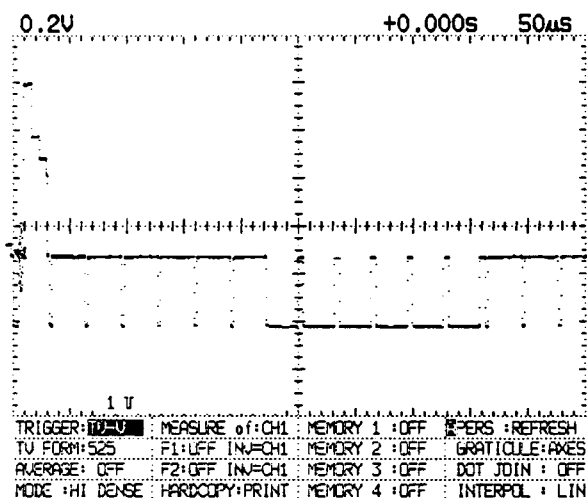

Fig. 6-14

### (2) TV-H trigger mode

- ① Select the TV-H trigger mode by the fixed menu (1 line, 1 column).  
TRIGGER: TV-H
- ② The menu screen disappears and the read-outs of the TV-H trigger setup are displayed.  
An example of the waveform measured in the TV-H trigger mode is shown in Fig. 6-15.

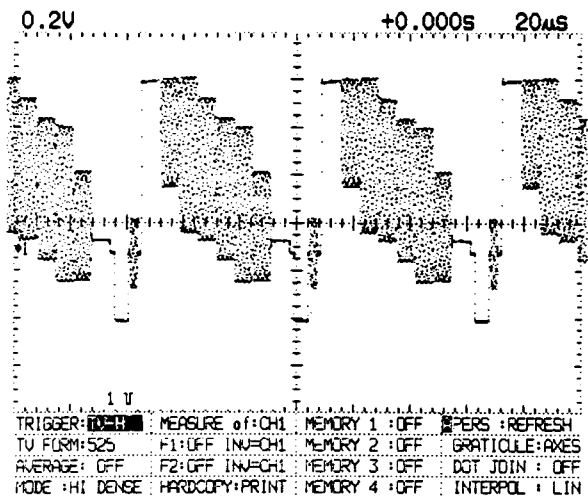

Fig. 6-15

### (3) TVLINE trigger mode

- ① Select the TVLINE trigger mode by the fixed menu (1 line, 1 column).  
TRIGGER: TVLINE
- ② Select the kind of a TV signal by the fixed menu (2 line, 1 column).  
NTSC: Set to TV FORM: 525.  
PAL: Set to TV FORM: 625.
- ③ The menu screen disappears and the read-outs of the TVLINE trigger setup are displayed.

An example of the waveform measured in the TVLINE trigger mode is shown in Fig.6-16.

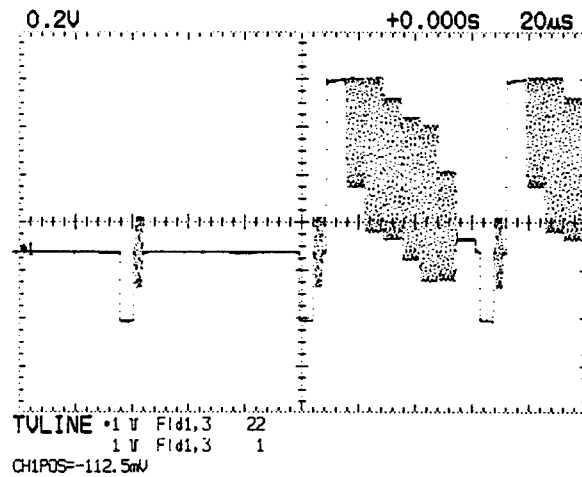

Fig. 6-16

#### (4) Panel operation in each mode

##### SOURCE



Specify a trigger source channel in the same way as the EDGE trigger mode.

CH1, CH2, CH3 and CH4 are available for the VC-7524/VC-7504.

CH1, CH2, EXT and EXT ÷ 10 are available for the VC-7502.

##### COUPLING





This key is invalid in the TV-V and TV-H trigger modes.

In the TVLINE mode, select fields 1 and 3 or 2 and 4.

##### SLOPE



(Note) Fields 1 and 3, and 2 and 4 are not discriminated.

Select the polarity (  ,  ) of a sync signal.

##### LEVEL



The LEVEL knob is invalid in the TV-V and TV-H modes.

A line number can be set by the LEVEL key in the TVLINE trigger mode.

A line number can be set within the following range according to the kind of the selected TV signal.

When TV FORM: 525 is selected

Fields 1 and 3: 1 thru 263 lines

Fields 2 and 4: 1 thru 262 lines

When TV FORM: 625 is selected

Fields 1 and 3: 1 thru 313 lines

Fields 2 and 4: 314 thru 625 lines

## 6.7 Display formats of waveform

< Overwrite display convenient for observation of jitter and noise >

### 6.7.1 Overwrite display (PERSISTENCE)

<b>Functional description</b>	The format of the waveform displayed on the screen can be selected from the following. REFRESH: Only the new data from the data acquired successively is displayed. INFINITE: New data are overwritten successively with old data displayed.
<b>Selection</b>	Select REFRESH or INFINITE by the page menu (A pages, 1 line) PERS: REFRESH In this mode, only the new data from the data acquired successively is displayed. Use this mode to measure the newest waveform only.

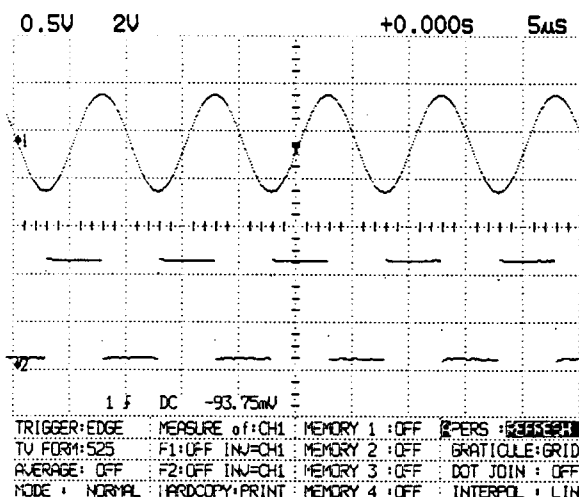

Fig. 6-17 Example of waveform display in REFRESH mode

PERS: INFINITE

In this mode, new data are overwritten successively on old data.

Use this mode to measure the magnitude of jitter and the timing margin between two signals.

**Note)** Though a hard copy of the overwritten waveform is obtained from the printer, a hard copy of only the waveform data acquired last is obtained from a plotter.

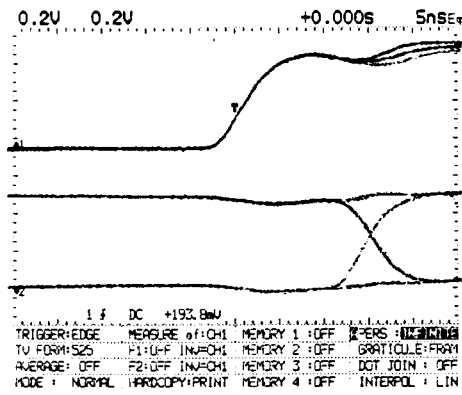

**Fig. 6-18 Example of waveform display in INFINITE mode**

### 6.7.2 Dot join display

**Functional descriptio**

This mode determines whether or not to join data and data of a waveform to be displayed.

ON : Measurement can be made by displaying dots between waveform data.

OFF: Only the collected waveform data can be displayed by dots.

**Selection**

Select ON or OFF by the page menu (A pages, 3 lines).

DOT JOIN: ON

As a waveform can be displayed with waveform data connected as shown below, a rising edge, a hazard, etc. can be easily measured.

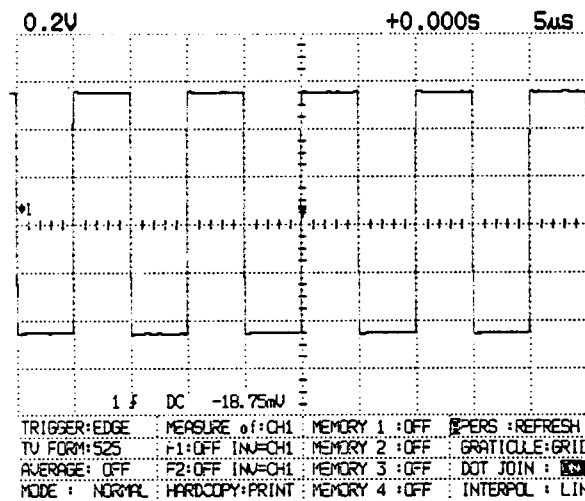

**Fig. 6-19 Example of display in DOT JOIN ON mode**

DOT JOIN: OFF

As only waveform data is displayed, a rising edge, etc. are hard to measure and data can be measured as if an oscilloscope is used.

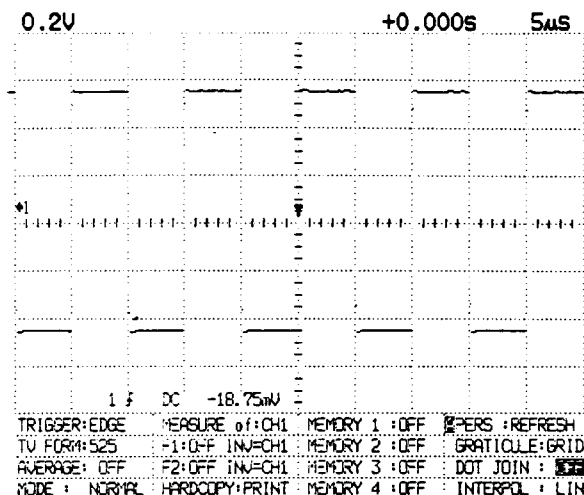

Fig. 6-20 Example of display in DOT JOIN OFF mode

**Note:** As the number of dots displayed increases in the DOT JOIN ON mode, the refresh speed of a waveform is remarkably lowered.

### 6.7.3 How to clear waveform (CLEAR WAVEFORM)

#### CLEAR WAVEFORM



To clear the displayed waveform, select the desired item on the first line CLEAR:on page menu B, and press the CLEAR WAVEFORM key. Then the waveform is cleared according to the content selected by CLEAR: on the menu.

**CLEAR:CURRENT:** All waveforms except for the recalled waveform are cleared.

**CLEAR:RECALL:** Only the recalled waveform is cleared.

**CLEAR:ALL:** All waveforms are cleared.

When RECALL or ALL is selected, all the recalled waveforms are cleared. For clear of individual recalled waveform, refer to 6. 18.

**Note:** As the waveforms cleared by this key cannot be displayed again, use care before clearing waveforms by this key.

It is recommended to save or copy important waveforms before clearing.

## 6.8 Average mode (AVERAGE)

< Measurement of only basic signal component after eliminating mixed noises >

**Functional description** When random noise (asynchronous noise) is included in an input signal, use the average mode to obtain the waveform from which noise is reduced. This instrument performs the exponential averaging. In this method, averaging is made so that the largest weighting is applied to the newest data by the specified attenuation constant and weighting applied to the past data is made smaller in sequence in term of the exponential function.

**Operation** Use the AVERAGE: on the fixed menu (3 lines, 1 column).  
 AVERAGE: OFF : Averaging is not performed.  
 AVERAGE: 2-256 : Waveforms are displayed in the average mode.  
 Select an attenuation constant in  $2^n$  steps in the range from 2 to 256.

### Algorithm

In the average mode, the following calculation is performed and the result is displayed.

$$\overline{X}_K = \underbrace{\frac{N-1}{N}}_{\text{Weight}} \overline{X}_{K-1} + \underbrace{\frac{1}{N}}_{\text{Weight}} X_K$$

$\overline{X}_k$  : Average value until kth sample data string (Kth sweep)

$X_k$  : Kth sample data string

N: Specified attenuation constant

The above formula is converted as follows.

$$\overline{X}_K = \overline{X}_{K-1} + \frac{1}{N} (X_K - \overline{X}_{K-1})$$

As shown below, this formula represents that (c) is obtained by adding "the result obtained by dividing the difference between (A) and (B) by N" to (A).

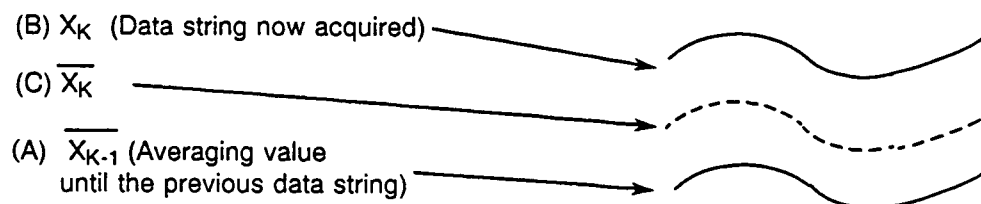

Fig. 6-21

### Caution:

- (1) When the HOLD/SINGLE key is pressed in the average mode, new processing is interrupted, and the result up to that time is held on the screen. When the RUN key is pressed, the data up to that time is cleared and processing starts from first.
- (2) The average mode is effective only for the repetitive signal. If trigger for acquiring a signal is insufficient, a waveform is distorted. To perform averaging correctly, set the trigger mode to NORMAL and connect a trigger signal to other channel.
- (3) When the acquisition mode is LONG or SPLIT(VC-7524 only), averaging is not performed.

## 6.9 Switching of scale (GRATICULE)

< Switching of scale display for easy measurement >

### Operation

Select a displayed scale from GRID, FRAME and AXES by the page menu (A pages, 3 lines).

#### ① GRID

The frame, axis and scale are all displayed, use this scale to measure waveform data value by matching a waveform to the scale.

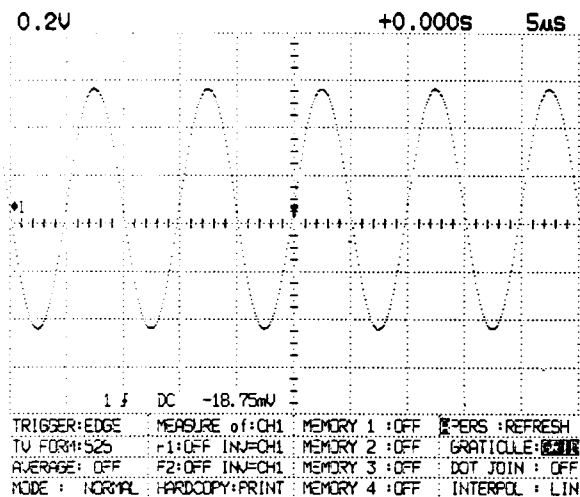

Fig. 6-22 GRID display

#### ② FRAME

Only the frame is displayed.

When it is not needed to use the scale on the screen or when the cursor or domain display are not desirable for measurement, select the FRAME mode.

This is convenient for cursor measurement, GO-NOGO function, etc.

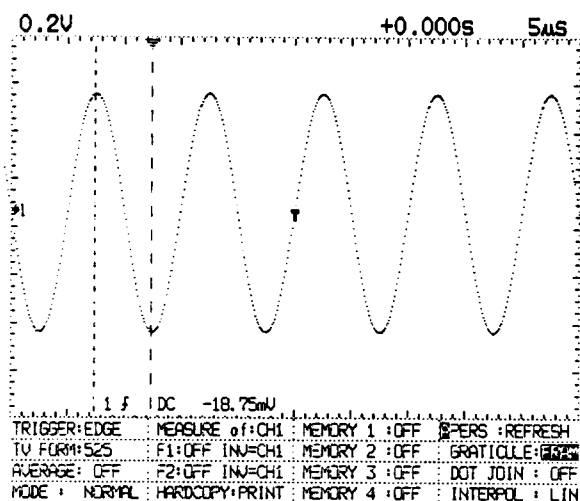

Fig. 6-23 FRAME display



### ③ AXES

The frame and axes (horizontal, vertical and center) are displayed.

Use this scale to measure a waveform by positioning on the center of the screen.

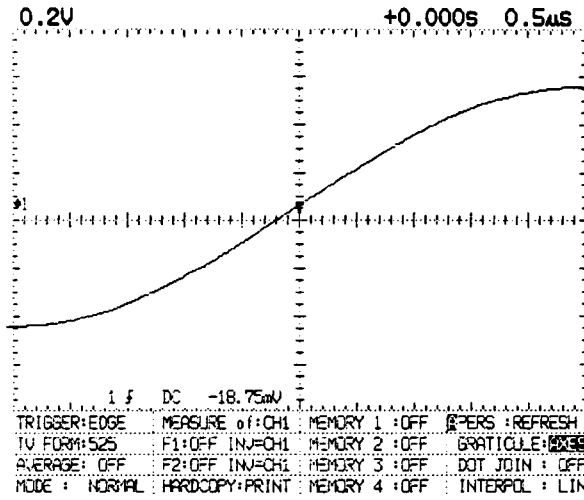

Fig. 6-24 AXES display

## 6.10 Operation function (MATHEMATIC)

<Measurement of waveform obtained by calculating signals >

**Function description** Inverted waveforms (INVERT), absolute value (ABSOLUTE) and the results of various operations (addition, subtraction and multiplication) between waveforms are displayed. The VERSUS display (X-Y display of two waveforms) is possible. Two kinds of operations can be performed at the same time.

**Operation** The ON/OFF selection of the operation function and the selection of operation items are made by the menus (2 lines, 2 columns) and (3 lines, 2 columns) of the fixed menu.

Operation 1 (F1) is selected by the menu (2 lines, 2 columns)

Operation 2 (F2) is selected by the menu (3 lines, 2 columns)

Selection of operation 1: Menu (2 lines, 2 columns)

F1:	_____ ON	:	Turns ON calculation and display of operation 1 (F1).
	_____ OFF	:	Turns OFF calculation and display of operation 1 (F1).
	_____ INV = CHi	:	Calculates the inversion (INVERT) of a waveform.
	_____ ABS = CHi	:	Calculates the absolute value (ABSOLUTE) of a waveform.
	_____ CHi + CHj	:	Adds two waveforms.
	_____ CHi - CHj	:	Performs subtraction between two waveforms.
	_____ CHi * CHj	:	Multiplies two waveforms.
	_____ CHi $\vee$ CHj	:	Displays the voltage vs voltage (X-Y) of a waveform.

In either case, select CH1, CH2, CH3, or CH4(CH1 or CH2 for the VC-7502) as a source channel signal of operations for CHi and CHj.

Selection of operation 2 (F2) = Menu (3 lines, 2 columns).

F2:	_____ ON	:	Turns ON calculation and display of operation 2 (F2).
	_____ OFF	:	Turns OFF calculation and display of operation 2 (F2).
	_____ INV = CHi	:	Calculates the inversion (INVERT) of a waveform.
	_____ ABS = CHi	:	Calculates the absolute value (ABSOLUTE) of a waveform.
	_____ CHi + CHj	:	Adds two waveforms.
	_____ CHi - CHj	:	Performs subtraction between two waveforms.
	_____ CHi * CHj	:	Multiplies two waveforms.
	_____ CHi $\vee$ CHj	:	Displays the voltage vs voltage (X-Y) of a waveform.

In either case, select CH1, CH2, CH3, or CH4(CH1 or CH2 for the VC-7502) as a source channel signal of operations for CHi and CHj.

### Operation function of each mode (VC-7524)

Acquisition mode	H MODE			
	A	ALT		B
		Original waveform	Magnified waveform	
NORM	○	○	○	○
HI DENSE	○	○	○	○
LONG	×	×	○*1	○*1
SPLIT	×	×	○*1	○*1
PILE	○	○	○	○

○ : Available

× : Not available

\*1) Available only when the displayed waveform data is magnified to less than 10kw.

### Contents of operation function

#### (1) Display of inverted waveform (INV)

(a) The waveform data of the channel specified by INV=CHi is inverted upside down with respect to the GND point.

(b) Fig. 6-25 is an example of the inverted CH1 input.

(INVERT)

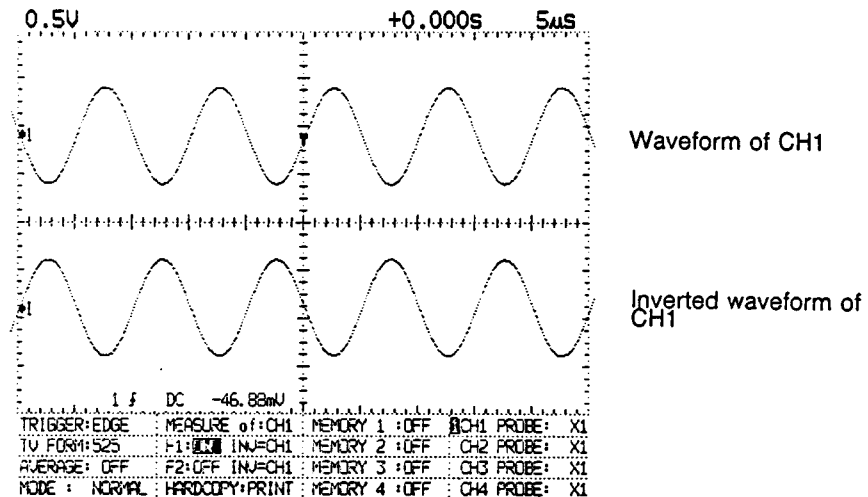

**Fig. 6-25 Example of inverted waveform (INV) by operation 1 (F1)**

- Perform the selection and setting as shown above.
  - The "I" mark is displayed at the GND point of the inverted waveform. The display position of this GND point moves differently from the vertical POSITION position of the original waveform. The purpose is to obtain the inverted waveform without being clipped in as wide a range as possible. Measure the inverted waveform with reference to this GND point.
- (c) Press the MENU key of the MENU section.
- Then, the menu disappears and the screen shown in Fig. 6-26 is displayed.

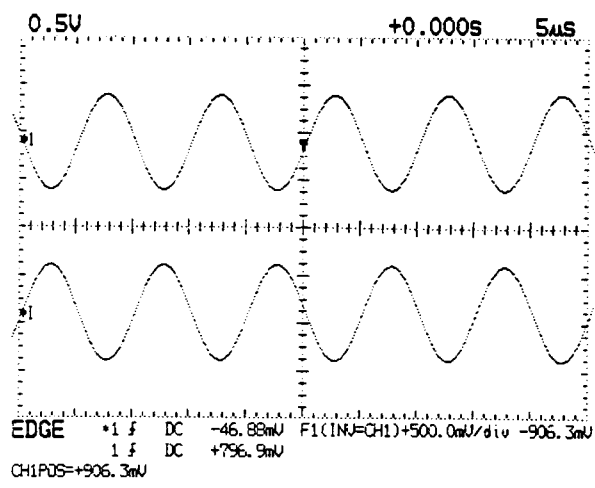
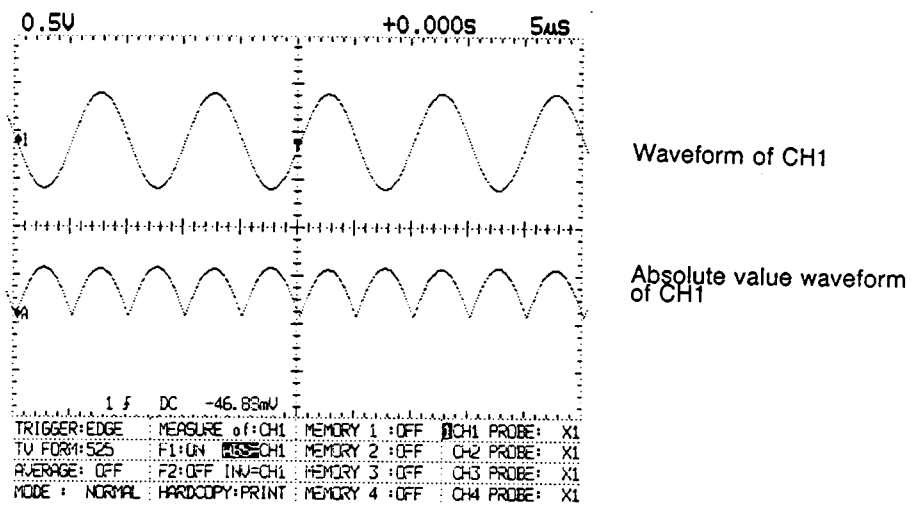

**Fig. 6-26 Example of inverted waveform screen**

- At the lower right portion of the screen, the operation number, kind of operation VOLTS/DIV value and GND level (voltage value from the center line of the screen to the GND point "I") of the operated waveform are displayed.
- When the display of CH1 is turned off by pressing the DISPLAY key of CH1, only the inverted waveform is displayed.

**(2) Display of absolute value waveform (ABS)**

- The absolute value of the channel specified by ABS = CHi is obtained with respect to the GND point.
- An example to obtain the absolute value (ABSOLUTE) of CH1 is shown in Fig. 6-27.



**Fig. 6-27 Example of inverted waveform (ABS) by operation 1 (F1)**

- Perform the selection and setting as shown in Fig. 6-27.
- The "A" mark is displayed at the GND point of the absolute value waveform.

The display position of this GND point moves differently from the vertical POSITION position of the original waveform.

The purpose is to obtain the absolute value waveform without being clipped in as wide a range as possible.

Measure the absolute value waveform with reference to this GND point.

- (c) Press the MENU key of the MENU section.

Then, the menu disappears and the screen shown in Fig. 6-28 is displayed.

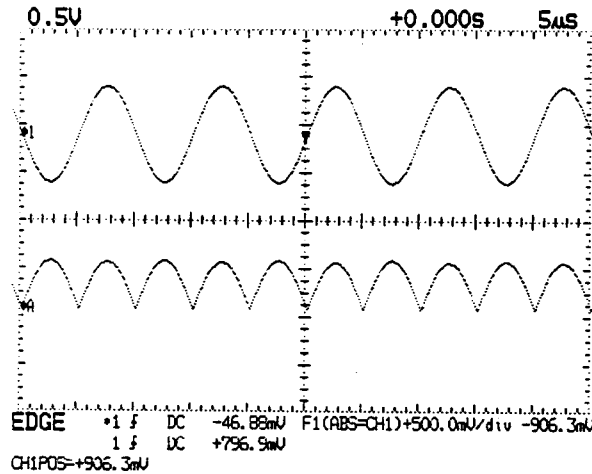
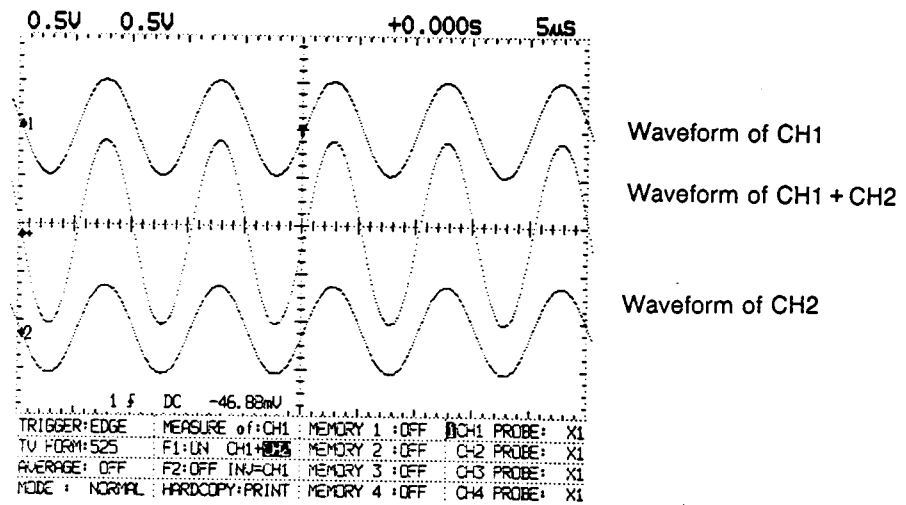

**Fig. 6-28 Example of absolute value waveform screen**

- At the lower right portion of the screen, the operation number, kind of operation, VOLTS/DIV value of the operated waveform, and GND level (voltage value from the center line of the screen to the GND point "A") are displayed.
- When the display of CH1 is turned off by pressing the DISPLAY key of CH1, only the inverted waveform is displayed.

### (3) Display of added waveform ( + )

- (a) The added value of the waveform data of channels i and j specified by CHi + CHj is obtained.
- (b) An example of the CH1 input waveform plus the CH2 input waveform is shown in Fig. 6-29.



**Fig. 6-29 Example of CH1 + CH2 selected by operation 1 (F1)**

- Perform the selection and setting as shown above.
  - The "+" mark is displayed at the GND point of the CH1 + CH2.  
The display position of this GND point moves differently from the vertical POSITION position of the original waveform.  
The purpose is to obtain the added waveform without being clipped in as wide a range as possible.  
Measure the added waveform with reference to this GND point.
- (c) Press the MENU key of the MENU section.  
Then, the menu disappears and the screen shown in Fig. 6-30 is displayed.

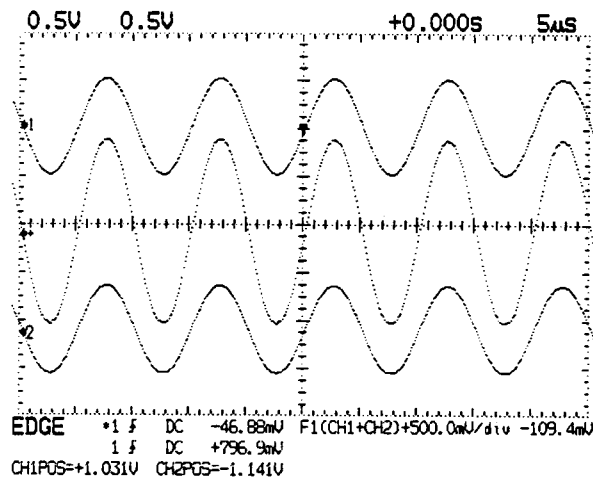

**Fig. 6-30 Example of added waveform screen**

- At the lower right portion of the screen, the operation number, kind of operation, VOLTS/DIV value of the operated waveform, and GND level (voltage value from the center line of the screen to the GND point" +") are displayed.

**Note:** The VOLTS/DIV value and the GND level value of the added waveform are displayed only when the VOLTS/DIV values of the two original waveforms are equal.

- When the displays of CH1 and CH2 are turned off by pressing the DISPLAY keys of CH1 and CH2, only the added waveform is displayed.

#### (4) Display of subtracted waveform (-)

- The waveform data of the channels i and j specified by CHi-CHj is obtained.
- An example of the CH1 input waveform minus CH2 input waveform is shown in Fig 6-31.

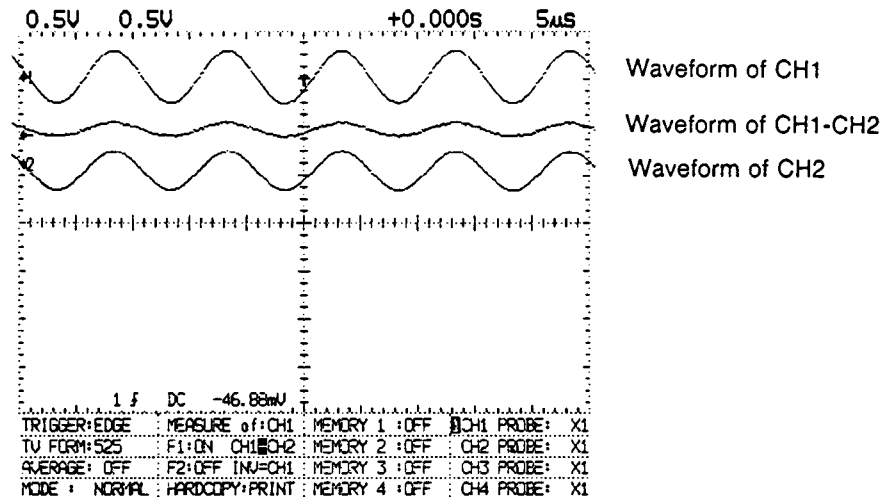

**Fig. 6-31 Example of CH1-CH2 selected by operation 1 (F1)**

- Perform the selection and setting as shown above.
- The "-" mark is displayed at the GND point of the CH1-CH2.  
The display position of this GND point moves differently from the vertical POSITION position of the original waveform.  
The purpose is to obtain the subtracted waveform without being clipped in as wide a range as possible.  
Measure the subtracted waveform with reference to this GND point.
- (c) Press the MENU key of the MENU section.  
Then, the menu disappears and the screen shown in Fig. 6-32 is displayed.

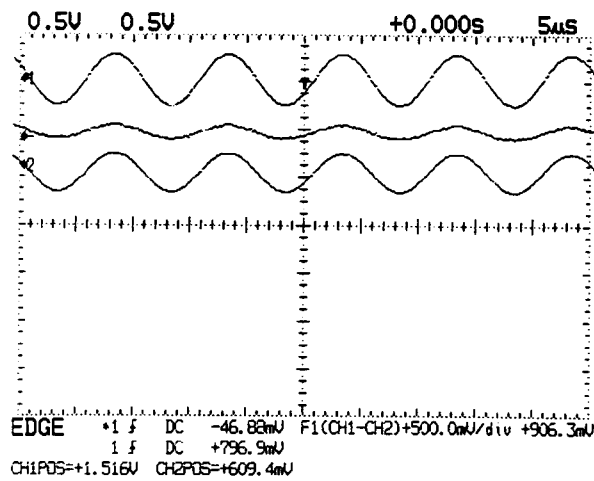

**Fig. 6-32 Example of subtracted waveform screen**

- At the lower right portion of the screen, the operation number, kind of operation, VOLTS/DIV value of the operated waveform, and GND level (voltage value from the center line of the screen to the GND point "-") are displayed.

**Note:** The VOLTS/DIV value and GND level value of the subtracted waveform are displayed only when the VOLTS/DIV values of the two original waveforms are equal.

- When the displays of CH1 and CH2 are turned off by pressing the DISPLAY keys of CH1 and CH2, only the subtracted waveform is displayed.

**(5) Display of multiplied waveform (\*)**

- The waveform data of the channels i and j specified by CHi\*CHj is obtained.
- An example of the CH1 input waveform \* CH2 input waveform is shown in Fig. 6-33.

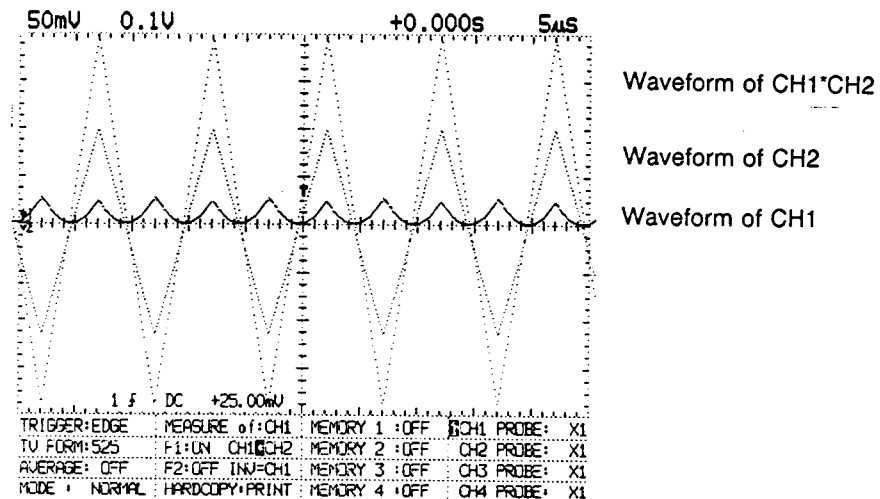

**Fig. 6-33 Example of CH1\*CH2 selected by operation 1 (F1)**

- Perform the selection and setting as shown above.



(c) Press the MENU key of the MENU section.

Then, the menu disappears and the screen shown in Fig. 6-34 is displayed.

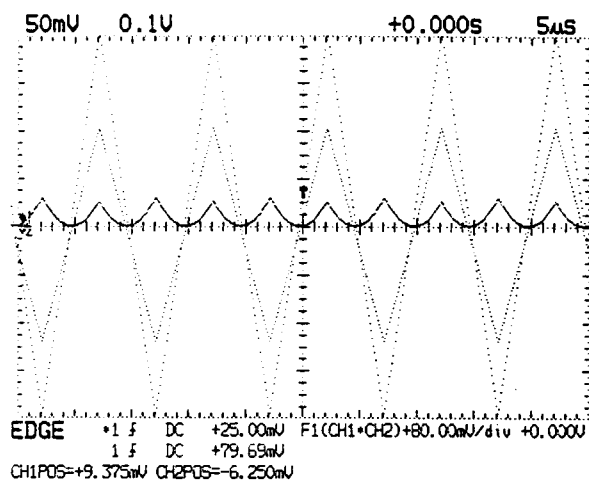

**Fig. 6-34 Example of multiplied waveform screen**

- At the lower right portion of the screen, the operation number, kind of operation, VOLTS/DIV value of the operated waveform, and GND level (voltage value from the center line of the screen to the GND point) are displayed.

**Note:** The VOLTS/DIV value and GND level value of the multiplied wave form are displayed only when the vertical positions of the two original wave forms are zero.

- When the displays of CH1 and CH2 are turned off by pressing the DISPLAY keys of CH1 and CH2, only the multiplied waveform is displayed.

## (6) Voltage vs voltage display (VERSUS)

- The voltage vs voltage display is performed with the waveform of channel i specified by CHi vs CHj as a horizontal axis (X axis) and with the waveform of channel j as the vertical direction (Y axis).
- An example of the voltage vs voltage display (VERSUS) is shown in Fig. 6-35.

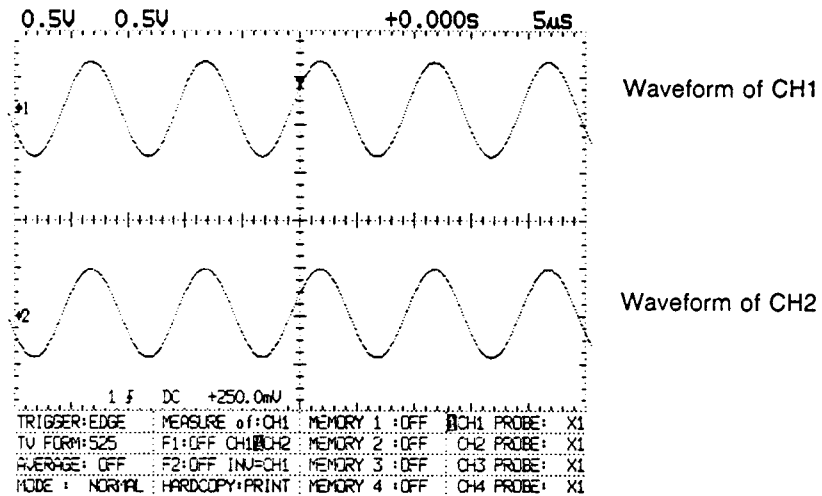

Fig. 6-35 Example of CH1 vs CH2 selected by operation 1 (F1)

- Perform the selection and setting as shown above.
  - When F1:ON is set, the VERSUS waveform is displayed.
  - At this stage, the original CH1 waveform, original CH2 waveform and VERSUS waveform are all overlaid on the screen.
  - When CH1 and CH2 displays are turned off by pressing the DISPLAY keys of CH1 and CH2, only the VERSUS waveform is displayed and measurement is made easily.
- Press the MENU key of the MENU section.  
Then, the menu disappears and the screen shown in Fig. 6-36 is displayed.

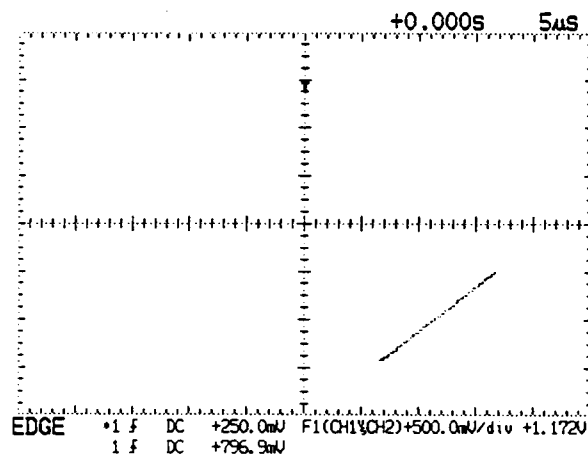

Fig. 6-36 Example of voltage vs voltage screen (VERSUS)

- At the lower right portion of the screen, the operation number, kind of operation, VOLTS/DIV value and GND level of the X-axis signal are displayed.

- When H MODE is set to ALT, a VERSUS waveform is displayed within the scale that magnified waveform is displayed.
- When H MODE is set to ALT or B and ZOOM is set to DUAL, a VERSUS waveform is displayed within the scale that the magnified waveform selected by the SELECT key is displayed.

**(7) Waveform operation display in the LONG or SPLIT mode (VC-7524 only)**

Select the desired operation item INV, ABS, +, -, \*, or VS as described in (1) to (6). Following is the description on the inversed waveform display (INV).

- (a) When the acquisition mode is LONG and the display mode is ALT, the inversed waveform as illustrated below is displayed.

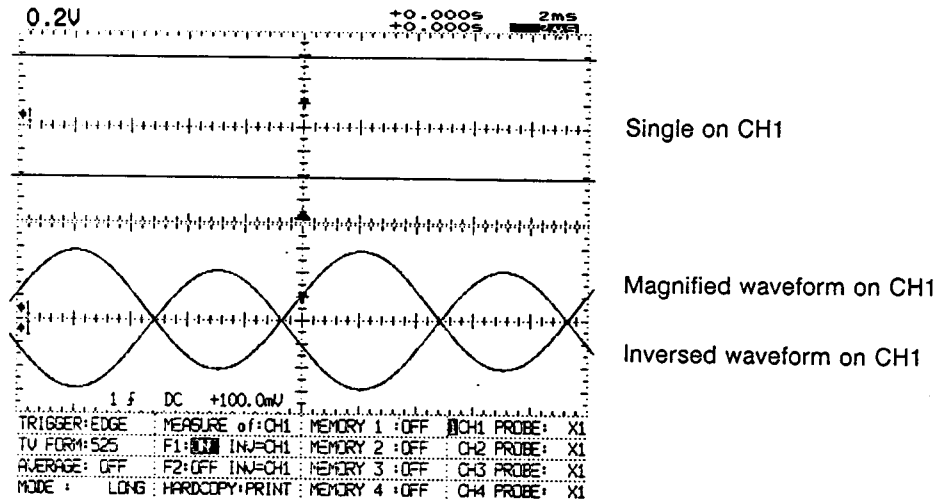

- Perform the selection and setting as shown above.
- The magnified waveform on CH1 and its inversed waveform are displayed on the same scale.

- (b) When the acquisition mode is SPLIT and the display mode is ALT, the inversed waveform is displayed as follows.

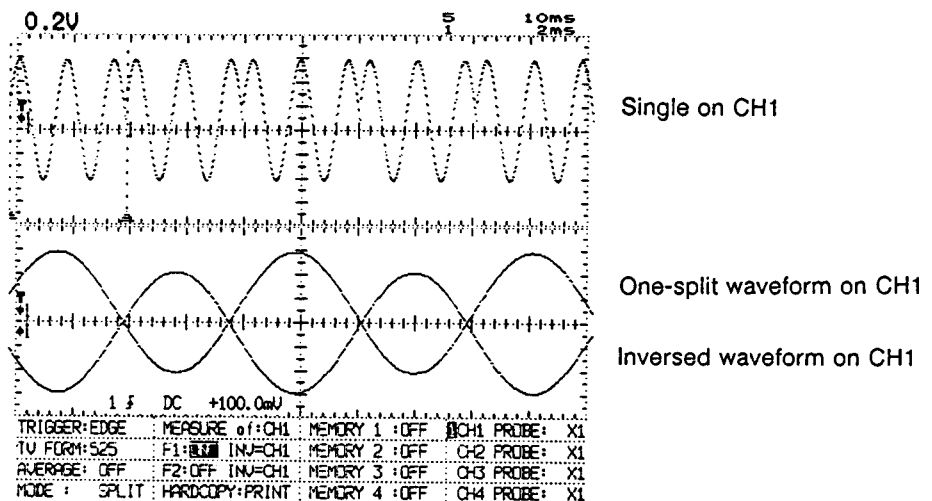

- Perform the selection and setting as shown above.
- The split waveform on CH1 and its inversed waveform are displayed on the same scale.

## 6.11 Calibration (CALIBRATION)

<Optimization of measurement environments >

### Functional description

The changes in measurement accuracy due to use environments (temperature, humidity, cable length of a probe, etc.) can be optimally corrected automatically or manually by activating the calibration.

It is recommended to perform calibration when any of the following cases applies.

- ① Before a customer starts to use this instrument first.
- ② When an ambient temperature changes more than 10°C , compared with that at the time of the previous calibration.
- ③ Every six months or 1000 hours
- ④ Optimization of measurement accuracy is required.

The following four kinds of calibration functions are available.

#### (1) FULL CALIBRATION

The changes in measurement accuracy of the vertical axis and trigger system caused by the change in use environments are all calibrated automatically.

#### (2) VPOS CALIBRATION

The VPOSITION of the vertical axis which is apt to be changed due to the change in temperature, etc. is calibrated automatically  
This calibration can be performed periodically.

#### (3) TRIG CALIBRATION

The time-related changes of the trigger inside the instrument can be calibrated manually. This calibration must be performed for each channel.

#### (4) SKEW CALIBRATION

The time-related changes of the trigger inside the instrument and for the cable length of a probe can be calibrated manually.

This calibration must be performed for the three pairs of channels; CH1 and CH2, CH1 and CH3, and CH1 and CH4,(CH1 and CH2 one pair only for the VC-7502) because the time difference between CH1 and another channel is calibrated.

### Operation

#### (1) Selection of calibration function

Four kinds of calibration function can be selected by the page menu (9 pages, 1 line).

#### (2) Setting of AUTO VPOS

When "AUTO VPOS" on the 2nd line on page 9 of the page menu is turned on, the POSITION of the vertical axis can be calibrated at the specified intervals, i.e. approx. 15 minutes after AUTO VPOS has been turned on, and later every approx. one hour. These intervals have been set previously.

Use this function to minimize the deviation of trace with respect to POSITION.

When this function is selected, the message "Calibration ... " is displayed, and this instrument does not accept any operation for approx. 5 to 10 seconds.

The time required for calibration is changed according to use environments.

### (3) Execution of FULL CALIBRATION

When "CAL EXEC" on the third line on page 9 of the page menu is selected and the VARIABLE knob is turned after the FULL CALIBRATION function has been selected, START is displayed and FULL CALIBRATION starts.

The following items to be executed by the FULL CALIBRATION function are displayed on the screen.

- ① INTERPOLATOR . . . . . Deviation of equivalent sample waveform.
- ② 2ND ATT BAL . . . . . Deviation of trace caused when attenuators are switched.
- ③ VERTICAL POSITION 1 . . . . . Deviation of trace at offset zero.
- ④ VERTICAL GAIN . . . . . Deviation of sensitivity of vertical axis
- ⑤ VERTICAL POSITION 2 . . . . . Readjustment of deviation of trace at offset zero
- ⑥ TRIGGER GAIN & LEVEL . . . . . Deviation of trigger point

When FULL CALIBRATION ends, the message "COMPLETE" is displayed, and the calibrated data are backed up.

### (4) Execution of VPOS CALIBRATION

When "CAL EXEC" on the third line on page 9 of the page menu is displayed and the VARIABLE knob is turned after the VPOS CALIBRATION function has been selected, START is displayed and VPOS CALIBRATION starts.

CAL VERTICAL POSITION1 is displayed on the screen.

When VPOS CALIBRATION ends, the message "COMPLETE" is displayed, and the calibrated data are backed up.

### (5) Execution of TRIG CALIBRATION

The deviation of waveform trigger point with respect to the DELAY=0.000s point (center of graticule) on the screen is adjusted.

When "CAL EXEC" on the third line on page 9 of the page menu is displayed and the VARIABLE knob is turned after the TRIG CALIBRATION function has been selected, START is displayed and TRIG CALIBRATION starts.

"Trigger skew +0.000s CH1" is displayed at the lower left portion of the screen.

At this time, this instrument is automatically set for calibration.

#### < Selection of a channel to be calibrated >

At the start of TRIG CALIBRATION, calibrate the youngest channel among of the channels turned on. The channel to be calibrated can be changed by pressing the DISPLAY key.

#### < Change of Trig skew >

After the desired channel is selected, the trig skew of the channel can be changed by the DELAY knob.

Thus, adjust so that the rising edge of the channel comes to the center of the screen as shown in Fig. 6-37.

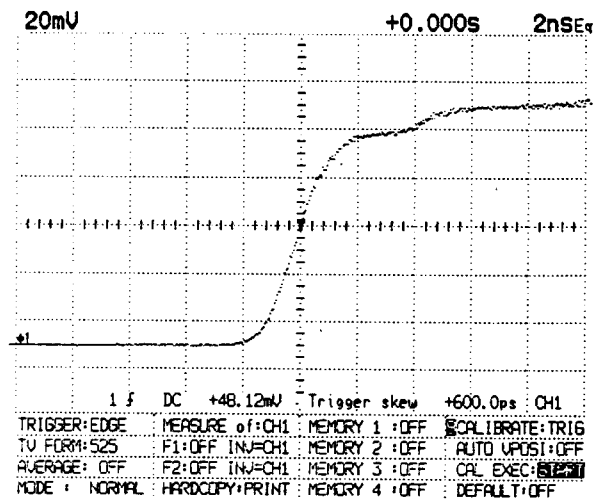

**Fig. 6-37 Execution of TRIG CALIBRAION**

**(6) Execution of SKEW CALIBRAION**

Prior to execution of this calibration, be sure to perform the trig skew correction described under (4).

In a high speed sweep range, the time difference between channels can cause due to the length of the cable or probe from the circuit under measurement.

With the SKEW CALIBRATION function, the time difference between the reference channel CH1 and other channels can be corrected to ensure accurate measurement.

When "CAL EXEC" on the third line on page 9 of the page menu is selected and the VARIABLES knob is turned after SKEW CALIBRATION has been selected, START is displayed and SKEW CALIBRATION starts. "Channel skew + 0.000s CH2" is displayed at the lower left of the screen.

At this time, this instrument is automatically set for calibration.

**< Selection of a channel to be calibrated >**

At the start of TRIG CALIBRATION, calibrate channel 1 and the youngest channel among of the channels turned on.

The channel to be calibrated can be changed by pressing the DISPLAY key of channels 2 thru 4(VC-7502 is not provided with channel 3 and 4 ).

**< Change of channel skew >**

After the desired channel is selected, the channel skew of the channel can be changed by the DELAY knob.

Adjust so that the rising edges of the two calibrated channels coincide as shown below.

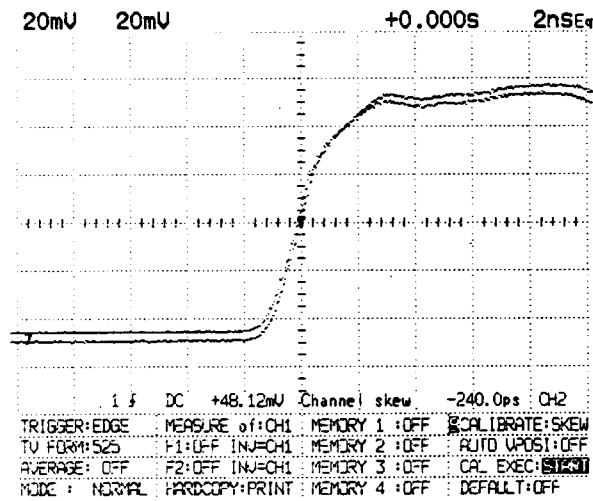
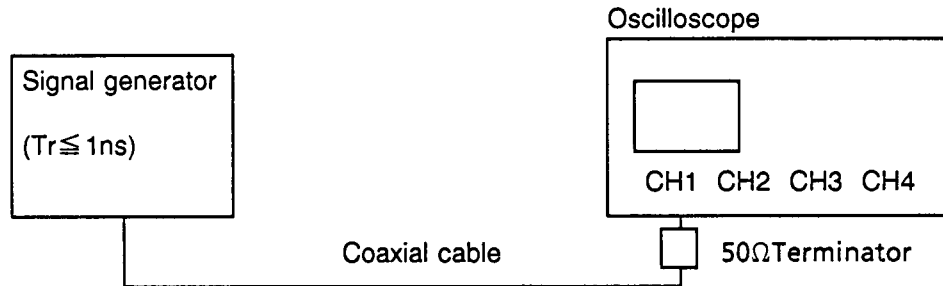

**Fig. 6-38 Execution of SKEW CALIBRAION**

**(7) Connection in TRIG CALIBRATION and SKEW CALIBRATION mode**

**(a) Example of connection in TRIG CALIBRATION**

To correct the trig skew of CH1, connect the units as shown in Fig. 6-39.



**Fig. 6-39 Connection diagram in trig skew correction mode**

Connect a square wave having excellent rise characteristics to CH1 and set as follows.

- CH1 INPUT: ON
- VOLTS/DIV: Amplitude of 4 to 6 DIV on screen
- OFFSET: Half amplitude at horizontal center scale line
- TIME/DIV: 2ns
- TRIGGER SOURCE: CH1

**(b) Example of connection in SKEW CALIBRATION**

To correct the channel skew between CH1 and CH2, connect the units as shown in Fig. 6-40.

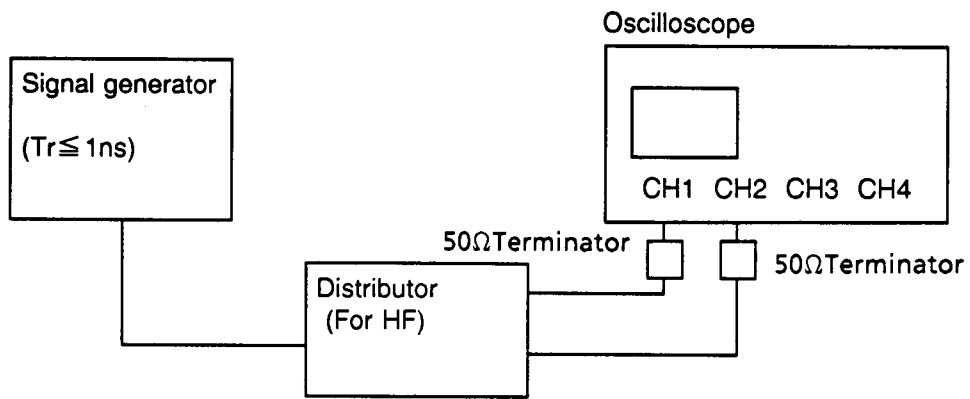

**Fig. 6-40 Connection diagram in channel skew correction mode**

Connect a square wave having excellent rise characteristics to CH1 and CH2 simultaneously via the distributor and set as follows.

INPUT (CH1 and CH2): ON

VOLTS/DIV: Amplitude of 4 to 6 DIV on screen (Same setting for CH1 and CH2)

OFFSET: Half amplitude at horizontal center scale line (Same setting for CH1 and CH2)

TIME/DIV: 2ns

TRIGGER SOURCE: CH1 or CH2

**Caution:**

When the message "NOT COMPLETE" is displayed during execution of FULL CALIBRATION, try to perform the calibration from the start several times.

If "NOT COMPLETE" is still displayed, contact your local Hitachi Denshi sales representative.



## 6.12 Cursor measurement function(CURSORS)

< Numerical measurement of voltage and time differences between two points of waveform >

### Functional description

The voltage and time of the displayed waveform can be measured automatically only by setting the position of cursors. At the same time, the results (cursor readouts) are displayed at the lower portion of the screen.

### Kinds of cursors

Three kinds of cursors are available for the cursor measurement function.

- Voltage measurement cursors (V CURSORS)  
Voltage measurement is performed by two horizontal cursors.
- Time measurement cursors (T CURSORS)  
Time and frequency measurements are performed by two vertical cursors.
- Cross cursor (+ CURSORS)  
Time and voltage between two points where the T cursor crosses a waveform are measured simultaneously.

### Operation

Take the following procedure for measurement.

- (1) Select the desired cursors.
- (2) Specify the desired channel.
- (3) Move the two cursors to the desired position.
- (4) Read the cursor read-out values displayed at the lower portion of the screen.

### CURSORS



### PARAMETERS

#### (1) Selection of the desired cursors

Each pressing the CURSORS key of the MEASURE section selects cursor function and pulse parameter function in the following order.  
For the pulse parameter function, see Section 6.13.

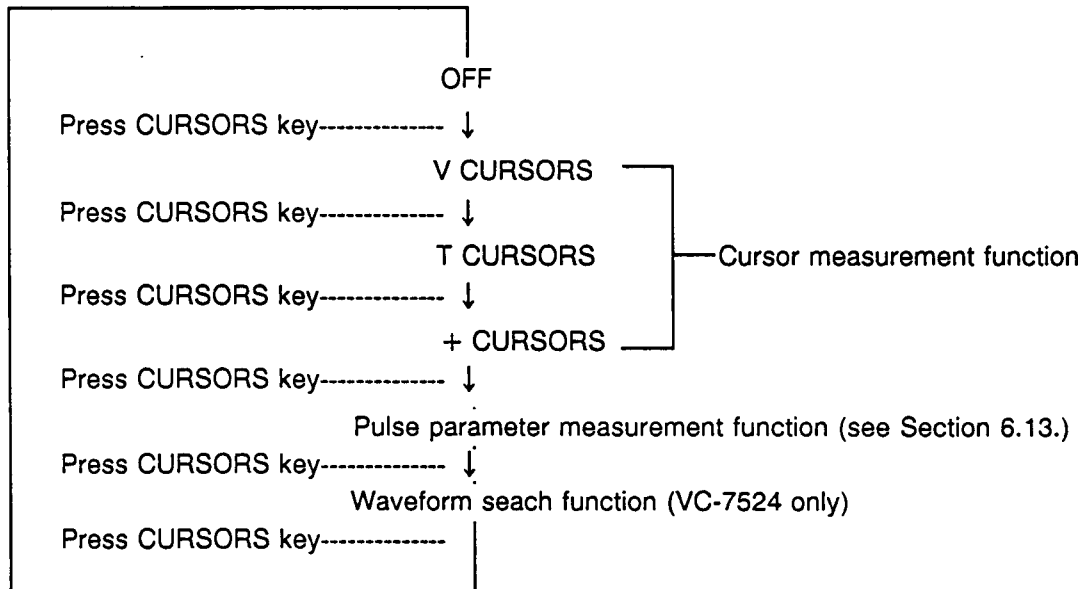
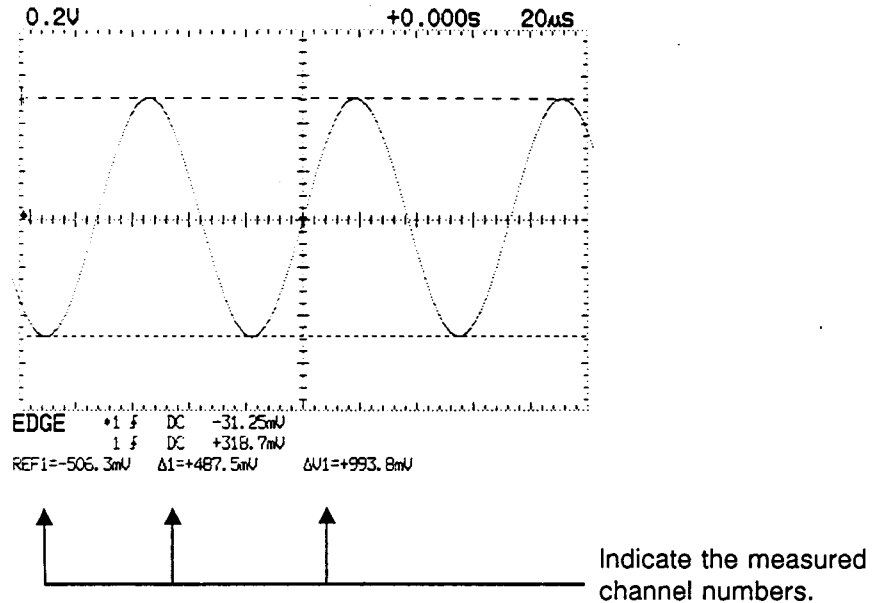

Fig. 6-41

Fig. 6-41 shows an example of cursors displayed in each selection mode.

## (2) Specification of the measurement channel

When the cursor measurement function is selected, the cursor read-outs are displayed as follows.



The suffix of each parameter represents the measured channel number.  
To perform correct cursor measurement, specify the desired channel.

Fig. 6-42

### How to specify a measurement channel

Specify a measurement channel by the fixed menu (1 line, 2 columns).  
MEASURE of: Specify a channel corresponding to the measurement channel.

### (3) Movement of cursor

In case of V CURSORS, the cursor marked ► at the left edge can be moved.  
In case of T CURSORS and + CURSORS, the cursor marked ▼ at the top edge can be moved.

The cursor to be moved can be selected by the REF.△. TRACK key of the MEASURE section.

Each pressing this key moves the mark from one cursor to the other.

The cursor with a mark can be moved by the VARIABLES key.

REF.△  
·TRACK  
[ ]  
SELECT

### VARIABLES



When two cursors are marked, the two cursors move parallel with equal space maintained.

## Cursor read-outs

The measured values as listed below are displayed according to the selected cursors.

(1) In case of voltage measurement cursors (V CURSORS) (See Fig. 6-44 )

Symbol	Content
REFi	Voltage level of REF cursor (with reference to GND)
$\Delta i$	Voltage level of $\Delta$ cursor (with reference to GND)
$\Delta Vi$	Voltage of $\Delta$ cursor - Voltage of REF cursor

(2) In case of time measurement cursors (T CURSORS) (See Fig. 6-45)

Symbol	Content
REFi	Time of REF cursor (with reference to trigger)
$\Delta i$	Time of $\Delta$ cursor (with reference to trigger)
$\Delta Ti$	Time of $\Delta$ cursor - Time of REF cursor
$1/\Delta Ti$	Reciprocal of $\Delta Ti$ (Frequency)

(3) In case of cross cursors ( + CURSORS) (See Fig.6-46 )

Symbol	Content
REFi	Voltage level at point where REF cursor crosses waveform (with reference to GND)
$\Delta i$	Voltage level at point where $\Delta$ cursor crosses waveform (with reference to GND)
$\Delta Vi$	Voltage of $\Delta$ cursor - Voltage of REF cursor
$\Delta Ti$	Time of $\Delta$ cursor - Time of REF cursor

## Example of cursor displays

(1) When OFF is selected

No cursor is displayed.

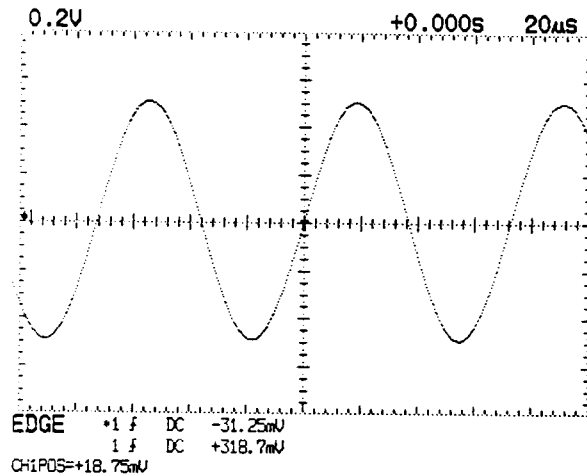

Fig. 6-43

(2) When V CURSORS is selected

Two horizontal cursors (REF and  $\Delta$  cursors) are displayed.

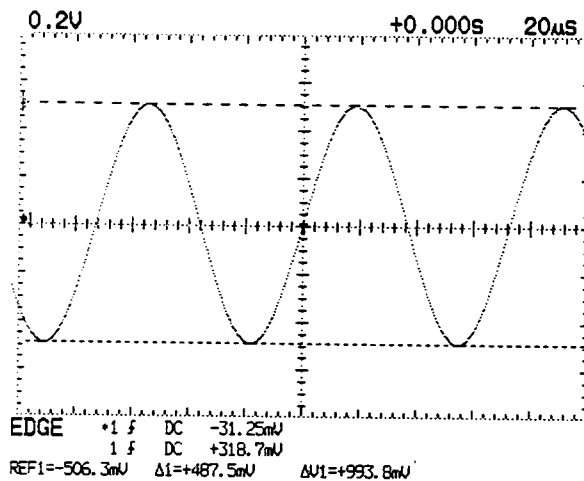

Fig. 6-44

**Note:** Clockwise rotation of the VARIABLES knob moves the V CURSORS upward, while counterclockwise rotation of the knob moves the cursors downward.

(3) When T CURSORS is selected

Two vertical cursors (REF and  $\Delta$  cursors) are displayed.

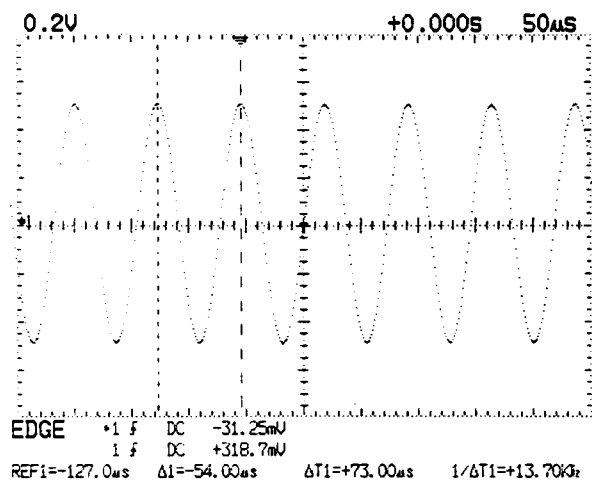

Fig. 6-45

Note: Clockwise rotation of the VARIABLES knob moves the T CURSORS rightward while counterclockwise rotation of the knob moves the cursors leftward.

(4) When + CURSORS is selected

Four cursors (two horizontal cursors and two vertical cursors) are displayed.

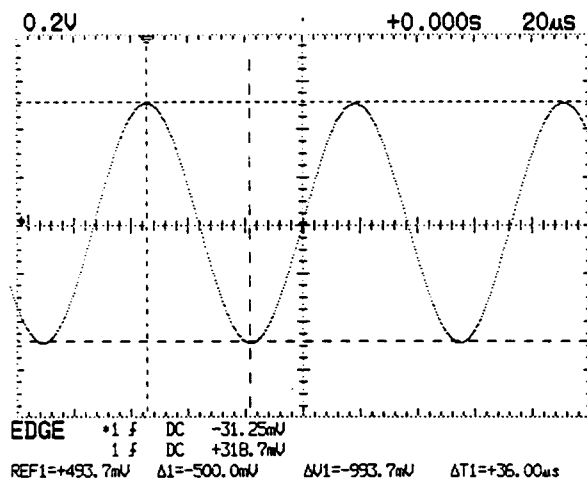
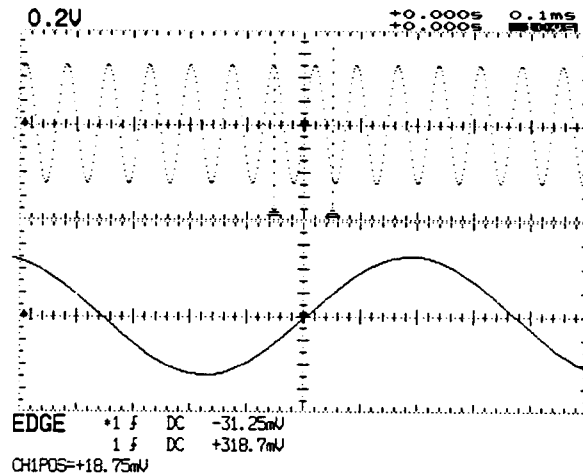

Fig. 6-46

## Example of cursor displays(In H MODE:ALT mode) VC-7124 only

(1) When OFF is selected

No cursor is displayed.



(2) When V CURSORS is selected

Two horizontal cursors (REF and  $\Delta$  cursors) are displayed.

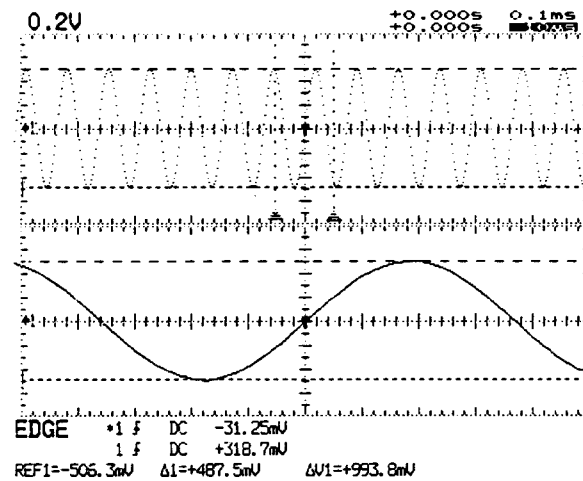

**Note:** Clockwise rotation of the VARIABLES knob moves the V CURSORS upward, while counterclockwise rotation of the knob moves the cursors downward.

(3) When T CURSORS is selected

Two vertical cursors (REF and  $\Delta$  cursors) are displayed.

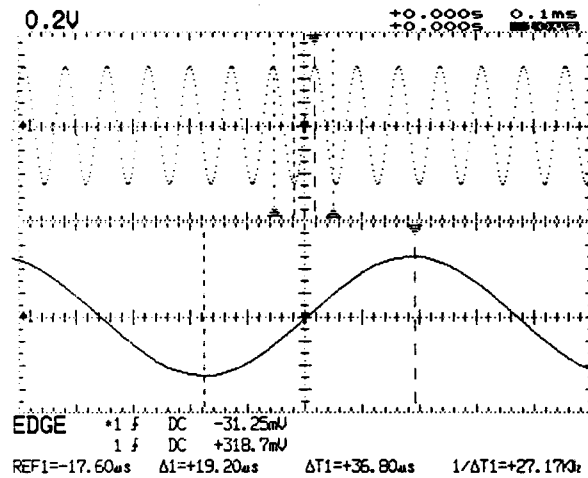

**Note:** Clockwise rotation of the VARIABLES knob moves the T CURSORS rightward while counterclockwise rotation of the knob moves the cursors leftward.

(4) When + CURSORS is selected

Four cursors (two horizontal cursors and two vertical cursors) are displayed.

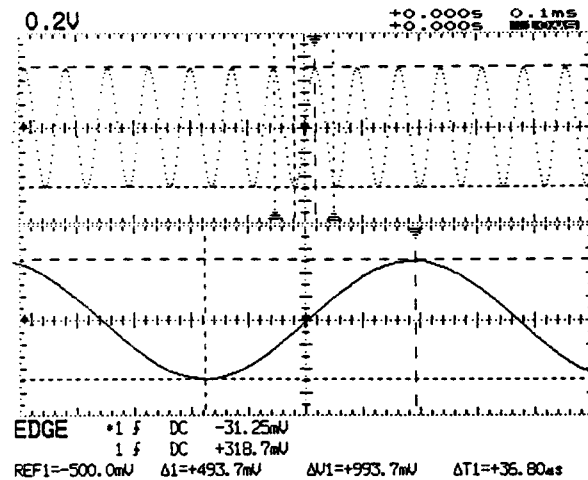

## 6.13 Pulse parameter measurement function (PARAMETERS)

<Numerical measurement of waveform pulse parameters>

### Functional description

The pulse parameters of the waveform displayed on the screen are automatically measured.

This instrument has the calculation function for 17 kinds of pulse parameters, and the results of four pulse parameters are displayed simultaneously on the screen.

Measured results are updated whenever waveforms are updated.

### Measured items

Table 6-4 lists the measurable pulse parameters.

The definition of each parameter conforms to IEEE std. 194-1977 IEEE Standard Pulse Terms and Definitions. (See Fig. 6-47. )

**Table 6-4**

No.	Parameter	Abbr.	Unit	Definition
1	Frequency	FREQ	Hz	The reciprocal of the time of the first period of a waveform. 0Hz when one period is not present.
2	Period	PER	Sec	The time of the first period of a waveform. 0sec when one period is not present.
3	Rise-time	RISE	Sec	The time interval between 10% point and 90% point of the amplitude (difference between TOP value and Base value) at the first rising edge of a waveform.
4	Fall-time	FALL	Sec	The time interval between 90% point and 10% point of the amplitude (difference between TOP value and Base value) at the first falling edge of a waveform.
5	Positive-width	+WID	Sec	The time interval between two points where the first positive pulse of a waveform crosses the 50% level of the amplitude (difference between TOP value and Base value).
6	Negative-width	-WID	Sec	The time interval between two points where the first negative pulse of a waveform crosses the 50% level of the amplitude (difference between TOP value and Base value).
7	Duty-cycle	DUTY	%	The ratio of a positive pulse width to a period at the first period of a waveform.
8	Minimum	MIN	Volt	The minimum value of a waveform.
9	Maximum	MAX	Volt	The maximum value of a waveform.
10	Peak-to-peak	VP-P	Volt	The difference between the maximum value and the minimum value (MAX-MIN).



**Table 6-4 (Continued)**

No.	Parameter	Abbr.	Unit	Definition
11	Base	BASE	Volt	The value of the highest frequency point below 5% frequency among the points which are below the middle point between the maximum value and the minimum value of a waveform. If the maximum frequency is below 5%, the Minimum value becomes the Base value.
12	Top	TOP	Volt	The value of the highest frequency point below 5% frequency among the points which are below the middle point between the maximum value and the minimum value of a waveform. If the maximum frequency is below 5%, the Maximum value becomes the TOP value.
13	Amplitude	AMP	Volt	The difference between TOP and Base of a waveform.
14	Preshoot	PRE	Volt	The amount of the transient of a waveform which occurs immediately before the first rising or falling edge of a waveform. When the first edge is rising: Base-Minimum When the first edge is falling: Maximum-TOP
15	Overshoot	OVER	Volt	The amount of the transient of a waveform which occurs immediately after the first rising or falling edge of a waveform. When the first edge is rising: Maximum-TOP When the first edge is falling: Base-Minimum
16	RMS	RMS	Volt	The RMS voltage of the first period of a waveform. 0V when one period is absent.
17	Average	AVG	Volt	The average voltage of the first period of a waveform. 0V when one period is absent.

**Note)** For details of formula of each parameter, see Appendix A.

**Note:** Pulse parameter measurement is performed for the pulse of the first cycle within the calculation range. As this measurement is performed with the reference to the edge crossing the 10% and 90% points of the amplitude of the pulse, an effective value is not obtained if a waveform of more than one cycle is not available for a sine wave or the like.

When a whole pulse is not displayed on the screen or when an effective value is not calculated for the measured parameter, the message "notfound" is displayed.

In the equivalent sampling mode, measurement cannot be performed until the data are converged and all data are displayed. In this case, the message "Data not Available" is displayed.

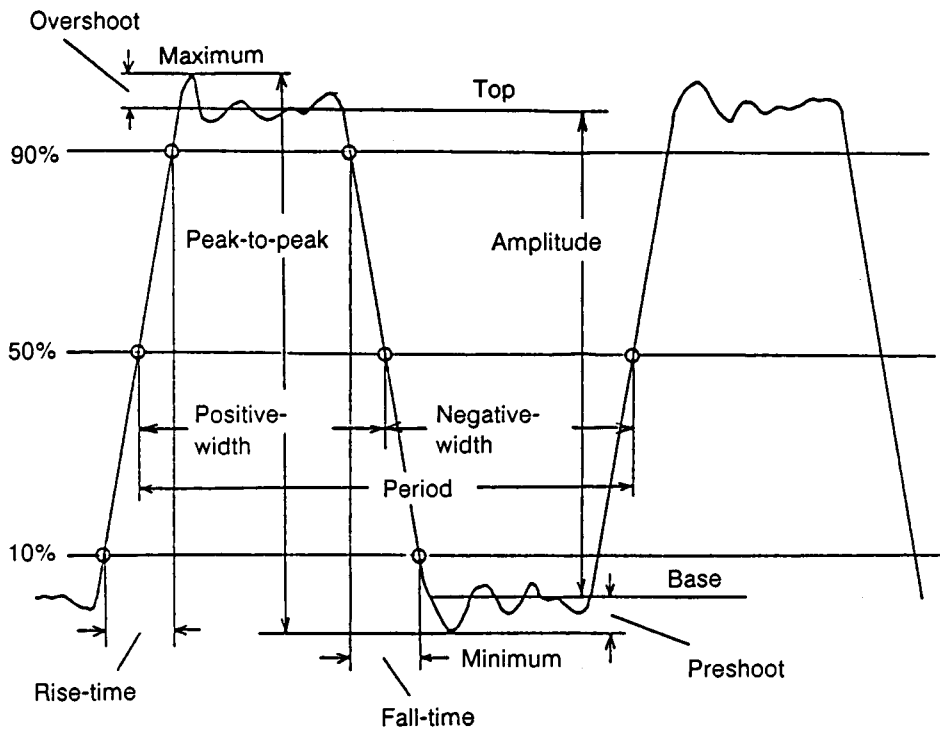

Fig. 6-47

Operation

CURSORS



PARAMETERS

(1) Selection of pulse parameter measurement function.

Pulse parameter functions can be selected by pressing the PARAMETERS key of the MEASURE section.

The MEASURE function includes the cursor measurement functions and the pulse parameter function, and these functions are selected in the following order by pressing this key.

The pulse parameter measurement function mode is established by pressing this key after the + CURSOR has been selected.

While the pulse parameters are being selected, four formulas after the respective pulse parameter's abbreviations are displayed as shown in Fig. 6-49 and Table 6-4 .

For the cursor measurement functions, see Section 6.12.

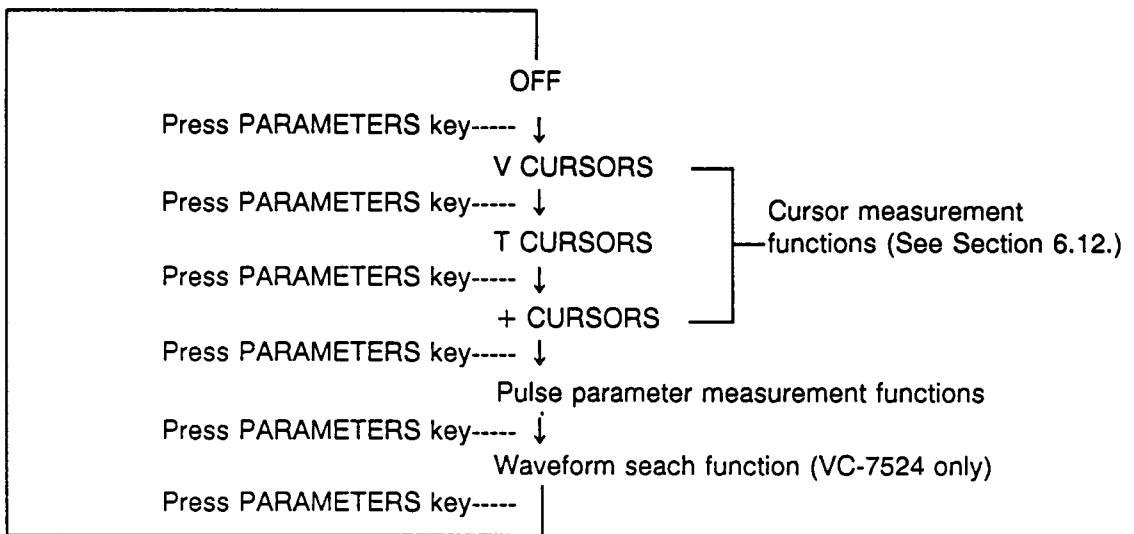
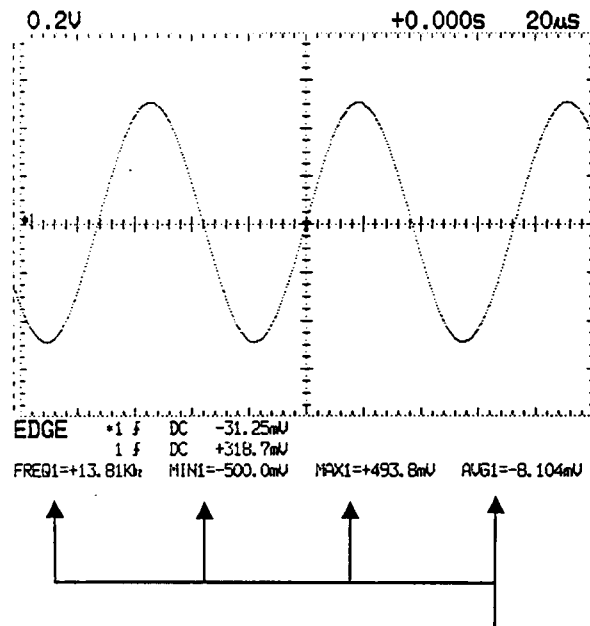

Fig. 6-48

## (2) Specification of the measurement channel

When the pulse parameter measurement function is selected, the pulse parameter read-outs are displayed as follows.

< Example of pulse parameter read-out display >



Indicate the measured channel numbers

The suffix of each parameter represents the measured channel number.  
To perform correct cursor measurement, specify the desired channel.

Fig. 6-49 Example of pulse parameter measurement function

**How to specify a measurement channel**

Specify a measurement channel by the fixed menu (1 line, 2 columns).

MEASURE of: CH1~CH4 (VC-7502 : CH1, CH2 only), M1~M4.

Specify a channel corresponding to the measurement channel.

**(3) Selection of parameter measurement items**

With the pulse parameter measurement function, four kinds of parameters among the parameter items listed in Table 6-4 can be measured simultaneously.

Select the desired parameter by the SELECT key and the VARIABLES knob.

- ① Pressing the SELECT key reverses the first parameter item of the displayed pulse parameter read-outs to indicate that this item can be changed. Another pressing this key moves the reversed mark to the item at the right side.

Move the reversed mark to the desired item.

- ② Select the desired item by rotating the VARIABLES knob.

REF.   
·TRACK



SELECT  
VARIABLES



**(4) Selection of parameter measurement calculation range**

In the factory setting mode, the parameter of each waveform of the first cycle is measured for all displayed waveforms.

Pulse parameter can be calculated for the desired portion of the displayed waveform by changing the pulse parameter measurement calculation range.

Pulse parameter calculation range can be changed by the SELECT key and the VARIABLES control.

- ① Press the SELECT key until the rightmost item of the pulse parameter read-out. Press the SELECT key further, then ▼ is displayed at the top of the vertical key. The cursor marked ▼ can be moved.

REF.   
·TRACK



SELECT

VARIABLES



- ② Rotate the VARIABLES control to move the cursor marked ▼ . The desired calculation range is thus selected.

For example, when it is needed to measure the pulse of the second cycle of the displayed waveform, set the cursor to the immediate before the rising (or falling) edge of the pulse so that the whole pulse of the second cycle is within the calculation range between the cursors.

**Caution:**

**(1) Waveform to which parameters are calculated**

- When two or more waveforms, edges or pulses are displayed, parameters are calculated for the first phenomenon (leftmost phenomenon on the screen)
- When the acquisition mode is SPLIT (VC-7524 only) and H MODE is A, the parameters are not calculated, and "Data Not Available" is displayed at the upper part of the screen. To allow the parameters to be calculated, set H MODE to ALT or B so that the magnified waveform (less than 10kW) is handled.
- In the equivalent sampling mode, the parameters are not calculated until all data are sampled.  
"Data Not Available" is displayed until all data are sampled.
- When a waveform is magnified horizontally and the number of data is insufficient (VC-7524 only), the parameters are not calculated, and "Data Not available" can be displayed. In this case, select LIN or SIN for INTERPOL.

## **(2) Conditions required for the waveform to calculate parameters**

To calculate each parameter, the waveform must satisfy the following conditions.

When the waveform does not satisfy such conditions, "not found" is displayed for the specified parameter.

- ① Parameters having no condition  
Minimum (MIN), Maximum (MAX), Peak-to-peak (Vp-p), Base (BASE), Top (TOP), Amplitude (AMP)
- ② Parameter for which at least one rising edge or falling edge must be present  
Preshoot (PRE)  
Overshoot (OVER)  
Rise-time (RISE) ... Rising edge required  
Fall-time (FALL) ... Falling edge required
- ③ Parameter for which at least one pulse must be present  
Position-width (+Wid) ... Positive pulse required  
Negative width (-Wid) ... Negative pulse required
- ④ Parameters for which one cycle of waveform must be present  
Frequency (FREQ), Period (PER), Duty-cycle (DUTY), RMS (RMS), Average (AVG)

## **(3) Relation with acquisition mode**

- ① When the acquisition mode is HIGH DENSITY or PILE, the displayed waveform is as many as 8kW. Therefore, the measured value may not be displayed for a long time, because it takes much time until the waveform is converged in the equivalent sampling mode. In this case, use the NORMAL mode for measurement.
- ② When HIGH DENSITY is selected in acquisition mode, the measurement resolution can be enhanced for the measurement items regarding the axis.
- ③ When the acquisition mode is LONG or SPLIT (VC-7524 only), the parameters are not calculated for the waveform whose data is 10kW or more, and "Too Many Data" is displayed at the upper point of the screen. To allow the parameters to be calculated, set the number of displayed data to less than 10kW, using a horizontally magnified waveform or LENGTH.

## 6.14 Waveform search function (VC-7124 only)

< The acquired waveform is searched and displayed according to the setting conditions >

**Function description** When the acquisition mode is LONG or SPLIT, select the desired search condition from the following three items.

**PATTERN:** Searches and displays the waveform having the segment conforming (or not conforming) to the judgment region in the SPLIT mode.

**MAX:** Searches and displays the waveform of the block including the data in excess of the value indicated by the horizontal cursor in the LONG or SPLIT mode.

**MIN:** Searches and displays the waveform of the block including the data lower than the value indicated by the horizontal cursor in the LONG or SPLIT mode.

**Operation**

**SCREEN:** The magnified waveform displayed on one screen is scrolled as one block to left or right in the LONG or SPLIT mode.

(1) PATTERN search

- ① Hold the data in the memory split sampling (SPLIT) mode.
- ② Select PATTERN on the fourth row of page B of the page menu.
- ③ Create the desired judgment region. (Note 1)
- ④ Set the H mode to ALT.
- ⑤ Close the menu.
- ⑥ Press the CURSOR switch to display the judgment region.
- ⑦ When the  > ( <  ) key on the MENU section, search is started for the segments at the right (or left) side of the segments of the displayed original waveform.
- ⑧ When the segments conforming (or not conforming) to the judgment region are present, the segments are displayed, when such segments are absent, the information is displayed.

← Pressing the <  key starts to search data at the left side.

↓ Segments currently displayed.

→ Pressing the  > key starts to search data at the right side.

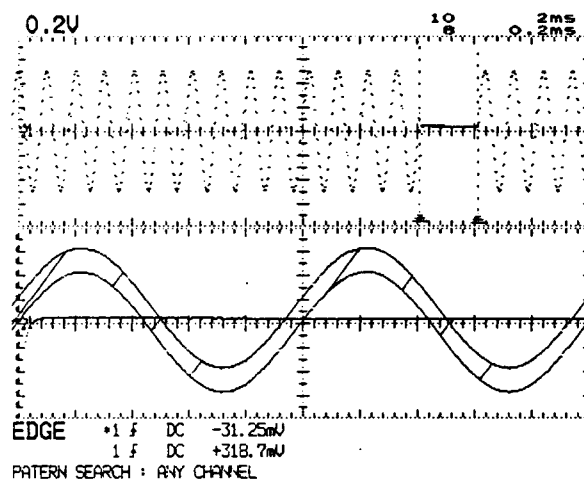

**(Note 1)**

- To reate the judgment region, refer to the edit of Boundary of the GO–NOGO judgment function.
- To select the desired channel and the judgment condition, refer to the selection of the NO–GOOD judgment conditions of the GO–NOGO judgment function.
- When the acquisition mode is other than SPLIT, the PATTERN search is not performed.
- In the equivalent sample mode, the PATTERN search is not performed even of the acquisition mode is SPLIT.

**(2) MAX and MIN searches**

- ① Hold in the LONG or SPLIT sampling mode.
- ② Select MAN or MIX on the fourth row of page B of the page menu.
- ③ Set the H mode to ALT.
- ④ Close the menu.
- ⑤ Press the CURSOR switch continuously until the horizontal cursor for reference is displayed.
- ⑥ Move the horizontal cursor by the VARIABLE control to set the reference value.
- ⑦ When the  > (< ) key on the MENU section, search is started for the block at the right (or left) side of the displayed original waveform.
- ⑧ When the blocks including data in excess of or lower than the value indicated by the horizontal cursor are present, the blocks are displayed. When such blocks are absent, the information is displayed.

Pressing the  > key starts to search data at the right side.      Pressing the <  key starts to search data at the left side.

Blocks currently displayed.

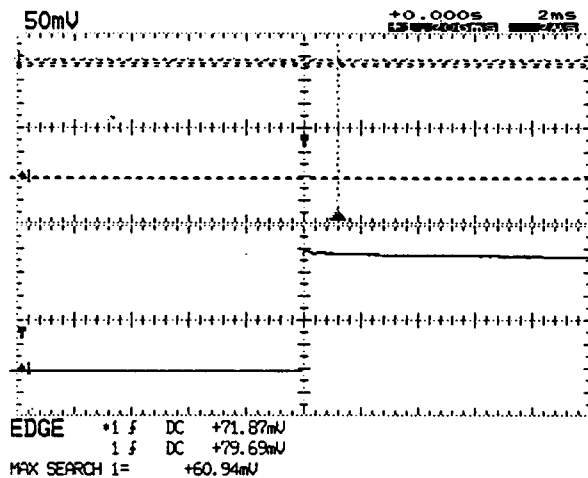

**(Note)**

- To select the desired channel, refer to the setting of the channel of MEASURE OF on the fixed menu (first row, second column).
- When the acquisition mode is other than LONG or SPLIT, the MAX and MIN searches are not performed.
- In the equivalent sampling mode, the MAX and MIN searches are not performed even if the acquisition mode is LONG or SPLIT.

### (3) SCREEN search (screen scroll)

- ① Hold the screen in the LONG or SPLIT mode.
- ② Select SCREEN on the found line on page B of page menu.
- ③ Set H MODE to ALT or B.
- ④ Close the menu.
- ⑤ Press the CURSOR switch until " SCREEN SEARCH" is displayed at the bottom left of the screen.
- ⑥ Press the key  > (or < ), then, the magnified waveform displayed on the screen is scrolled to right (or left).

Blocks currently displayed.

Pressing the key <  scrolls the waveform to left.      Pressing the key  > scrolls the waveform to right.

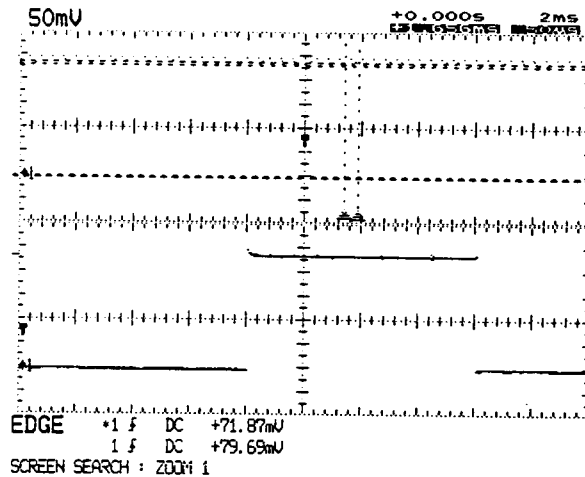

#### (Note)

- When DUAL is selected on ZOOM on the second line on page B of page menu, the magnified waveform selected by SELECT on the third line is scrolled.
- When the magnified waveform is scrolls at the right (left) edge of the original waveform, the scroll amount may be less than one screen.
- When the displayed segment range is exceeded when the waveform on one screen is scrolled in the SPLIT mode, the scroll amount is within the display segment. When a waveform is scrolled at the right (left) edge of the display segment, the first part of the next segment or the last part of the previous segment is magnified.
- When the acquisition mode is set to other than LONG or SPLIT, SCREEN search is not performed.
- In the equivalent sampling mode, SCREEN search is not performed even when the acquisition mode is set to other than LONG or SPLIT.



## 6.15 GO-NOGO judgment function

<Automatic judgment of signals, compared with preset conditions>

### Functional description

The GO-NOGO judgment function is used to judge if the acquired signal is in the judgment domain (Boundary) set on the screen.

The input signals collected in sequence are compared with the boundary. When the results satisfy the conditions, the waveform is sent to the built-in printer to produce a hard copy, or the waveform data are saved to the IC memory card. These processings are performed automatically.

This function is used to monitor abnormal phenomena which will occur not so frequently, or to detect undesired samples which will output signals different from the reference signal. Thus, only the signals which satisfy some conditions can be recorded.

The functions as listed below are available to select and set the conditions for judgment, processing performed after judgment, etc. so that the GO-NOGO judgment function can be used for various applications.

### (1) Edit function of boundary

The judgment domain can be created simply by using the waveform acquired previously as the reference waveform and by moving it horizontally and vertically.

### (2) Selection function of GO-NOGO judgment conditions.

The conditions to issue NO-GOOD can be selected. Select the condition to issue NO-GOOD from the following two options.

- ① When a waveform is within the judgment domain, or
- ② When a waveform is out of the judgment domain.

### (3) Selection function of processing Performed after judgment

If the result is GOOD, an L level signal is delivered from the BNC connector ( $\overline{\text{GO/NOGO}}$ ) on the rear. If NO-GOOD, an H level signal is delivered. This signal is delivered at any time when the GO-NOGO judgment function is activated.

In addition to this signal output, the processings listed below can be performed simultaneously.

- ① HOLD . . . . . Holds a NO-GOOD waveform on the screen.
- ② SAVE . . . . . Saves a NO-GOOD waveform to the IC memory card.
- ③ PRINT . . . . . Produces a hard copy of a NO-GOOD waveform by the built-in printer.
- ④ SRQ . . . . . When NO-GOOD is issued when this instrument is connected to a personal computer via the GPIB, the service request command is issued.

### (1) Edit of judgment domain

A judgment domain can be determined by editing the judgment boundary (Boundary) in the vertical direction and the boundary (Range) in the horizontal direction.

The menu (judgment domain edit menu) to perform this edit is on page 7 of the page menu.

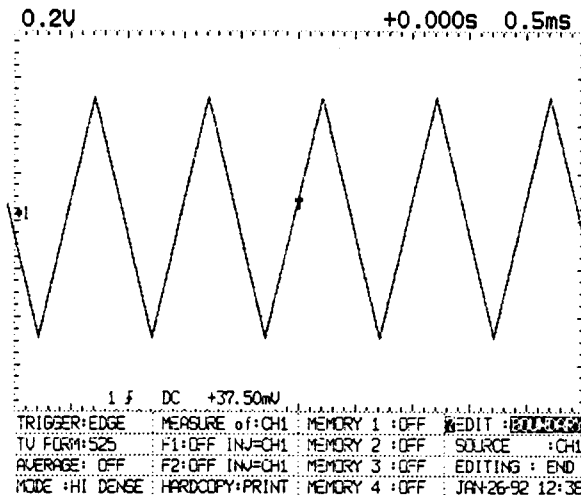

**Fig. 6-50 Example of display of judgment domain edit menu**

#### <Explanation of each menu of judgment domain edit menu>

- EDIT: To edit the boundary (judgment boundary in the vertical direction) or to set the range (judgment boundary in the horizontal direction) can be selected.
- SOURCE: The reference channel signal used to edit boundary can be selected.
- EDITING: To edit or not can be selected.  
 When START is selected, the boundary edit mode is established and the boundary can be created.  
 When END is selected, the edit mode ends.

#### <Edit of Boundary>

The boundary represents the boundary of the domain used to judge a signal in the vertical direction. Take the following procedure to perform this edit.

- ① Select boundary at the EDIT column (first line) of the judgment domain edit menu.  
 EDIT: BOUNDARY
- ② Select a channel whose signal is to be used as a reference at the BOUNDARY of the SOURCE column (second line).  
 The waveform which remains on the screen when EDINTING is started is used as a source of edit.  
 When editing is started in the RUN mode, a source waveform must be selected while the waveform on the screen change in sequence. To use the desired waveform as a source, determine the waveform in the HOLD mode, first, and then, perform edit.

- ③ START is selected at the EDITING column (third line), the EDIT mode starts, and the waveform of the channel selected at the SOURCE column is displayed on the screen.

EDITING: START ... Editing starts.

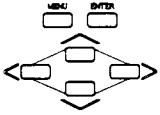

Create a boundary by moving the original waveform vertically and horizontally.

To move the waveform, specify the moving directions by the four keys of the MENU section, first and then rotate the DELAY knob of the HORIZONTAL section.

When the up and down keys are pressed, the boundary of the domain is moved upward by rotating the DELAY knob clockwise and downward by rotating the knob counterclockwise.

**DELAY**



When the left and right keys are pressed, the boundary is moved rightward by rotating the DELAY knob clockwise and leftward by rotating the knob counterclockwise.

Slant lines appear in the region enclosed by the upper and lower boundaries to indicate the NO-GOOD judgment domain.

The movement amount of the area for the referenced waveform is displayed on the screen.

UPPER indicates the movement amount to the upper direction. LOWER indicates the movement amount to the lower direction. RIGHT indicates the movement amount to the right direction. LEFT indicates the movement amount to the left direction. The movement amount to the direction that the figure is displayed in inverse video can be changed by the DELAY control.

- ④ After completion of the boundary creation, operate the ENTER key or the VARIABLES control to register the boundary.

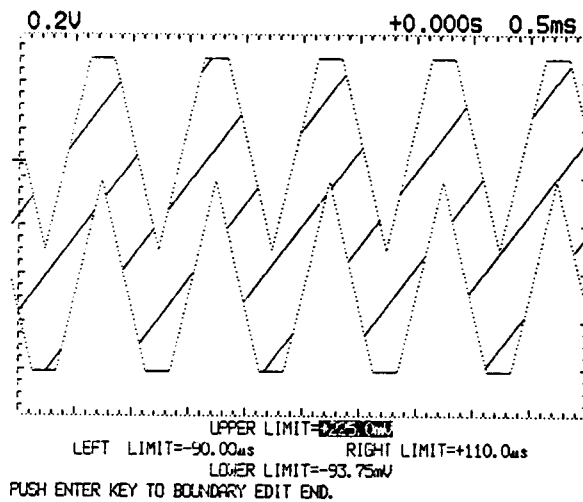

**Fig. 6-51 Example of boundary editing**

## <Setting of Range>

Range is used to limit and compare the width in the direction of the time axis within the set boundary range.

The time width is limited by using two bars (LEFT and RIGHT bars).

The comparison judgment range is specified by the two bars.

Take the following procedure to set the two bars.

- ① Select RANGE at the EDIT column (first line) of the judgment domain edit menu.  
EDIT: RANGE
- ② When START is selected at the EDITING column (third line), the EDIT mode starts and the two vertical bars appear.  
EDITING: START ... Setting starts.

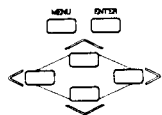

Determine the range by moving the two bars left and right.

Specify the bar to be moved by the left and right keys of the MENU section, and move the specified bar by the DELAY knob of the HORIZONTAL section.

DELAY



To move the bar (LEFT bar) which specifies the left edge of the judgment domain, press the left key  $\leftarrow$  and allow the  $\blacktriangledown$  mark to appear above the LEFT bar. Then, rotate the DELAY knob.

To move the bar (RIGHT bar) which specifies the right edge of the judgment domain, press the right key  $\rightarrow$  and allow the  $\blacktriangledown$  mark to appear above the RIGHT bar. Then, rotate the DELAY knob.

At this time, the movement amount of the area set by the boundary edit is displayed on the screen.

- ③ After completion of the range creation, operate the ENTER key or the VARIABLES control to register the range.  
EDITING: END ... Editing ends and the domain is registered.

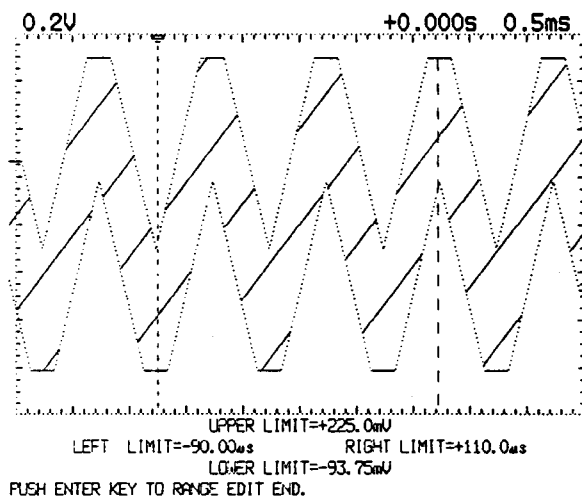

Fig. 6-52 Example of range setting

## (2) Selection of NO-GOOD judgment conditions

Select the conditions to perform the NO-GOOD judgment for the set domain by using the judgment condition selection menu.

This menu is on the second and third lines on page 6 of the page menu (see Fig. 6-53).

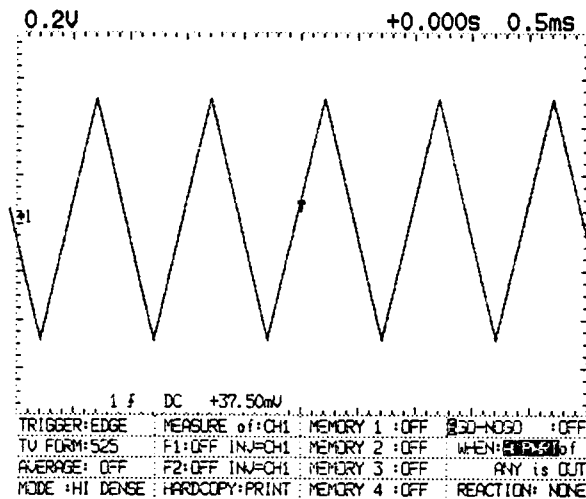

Fig. 6-53 Judgment condition selection menu

Judgment conditions can be specified by completing the following statement.

WHEN \*\*\*\* OF \*\*\* IS \*\*\*  
 ①                      ②                      ③

①, ② and ③ indicate options. Select the desired options by rotating the VARIABLES key after moving the highlighted marker to these positions.

The following options can be selected.

- ①:A PART or ALL
- ②:CH1, CH2, CH3, CH4, F1, F2 or ANY(VC-7502 is not provided with CH3, CH4 )
- ③:OUT or IN

For ②, select a channel whose signal is to be judged.

Four kinds of conditions can be selected by combination of the options of ① and ③. Following is an example of judging the signal of CH1.

(A) WHEN A PART OF CH1 IS OUT  
 ①                      ②                      ③

If any part of the measured waveform (CH1) between the LEFT and RIGHT bars is out of boundary, NO-GOOD judgment is issued.

(B) WHEN ALL OF CH1 IS OUT  
 ①                      ②                      ③

If all of the measured waveform (CH1) between the LEFT and RIGHT bars is out of boundary, NO-GOOD judgment is issued.

(C) WHEN A PART OF CH1 IS IN  
 ①                      ②                      ③

If any part of the measured waveform (CH1) between the LEFT and RIGHT bars is in boundary, NO-GOOD judgment is issued.

(D) WHEN ALL OF CH1 IS IN  
 ①                      ②                      ③

If all of the measured waveform (CH1) between the LEFT and RIGHT bars is in boundary, NO-GOOD judgment is issued.

**(3) Selection of processings required after judgment**

While the GO-NOGO judgment function is being executed, the TTL signal is delivered at all times according to the result of judgment.

Further the functions performed together with the GO-NOGO judgment function are available.

The selection of processings performed according to the result of judgment is performed on the fourth line on page 6 of the page menu.

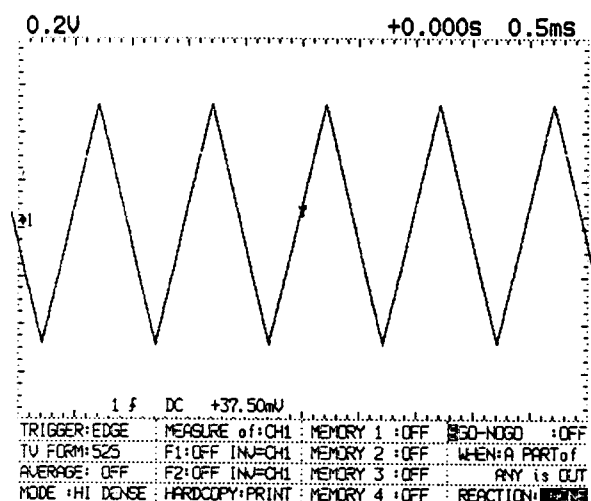

**Fig. 6-54 Selection menu of processing required after judgment**

One of the following options can be selected.

- ① HOLD ---- If the acquired signal is judged to be NO-GOOD, its waveform is held on the screen.  
 Press the RUN key to perform judgment next.
- ② SAVE ---- If the acquired signal is judged to be NO-GOOD, the waveform data is saved to the IC card. When all data is saved, the next sampling starts automatically and the GO-NOGO judgment is repeated.  
 Therefore, if the signals satisfying the NO-GOOD conditions are entered continuously, the waveforms are saved to the IC memory card continuously.
- ③ PRINT ---- If the acquired signal is judged to be NO-GOOD, the waveform is displayed and also sent to the built-in printer to produce a hard copy. After a hard copy is produced, the next sampling starts automatically, and the GO-NOGO judgment is repeated.

It takes approximately 50 seconds to produce a hard copy for data of one screen, and judgment is not performed for the signal entered during that period.

- ④SRQ ---- If the acquired signal is judged to be NO-GOOD, the service request command is issued to a personal computer via the GPIB to notify that the waveform satisfying the NO-GOOD conditions is obtained.
- ⑤NONE ---- If the acquired signal is judged to be NO-GOOD, only the TTL signal is delivered and other action is not taken.

#### (4) Execution of GO-NOGO judgment function

When the desired settings and selection of the above items (1)-(3) are performed correctly, execute the GO-NOGO judgment function. According to the first line menu on page 6 of the page menu.

Fig. 6-55 shows an example of this menu.

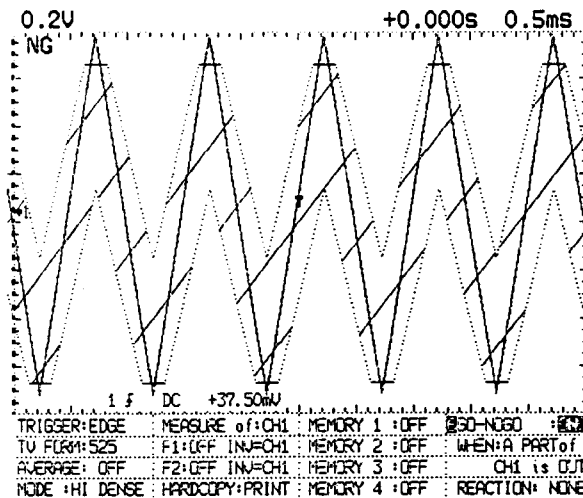

**Fig. 6-55 Execution command menu of GO-NOGO judgment function**

In the above figure,

GO-NOGO: ON ..... The GO-NOGO judgment function is executed.

GO-NOGO: OFF .... The GO-NOGO judgment function ends, and the normal operation mode is established.

#### (5) When H MODE is ALT, execution of GO-NOGO judgment function

When the desired settings and selection of the above items (1)-(3) are performed correctly, execute the GO-NOGO judgment function. According to the first line menu on page 6 of the page menu.

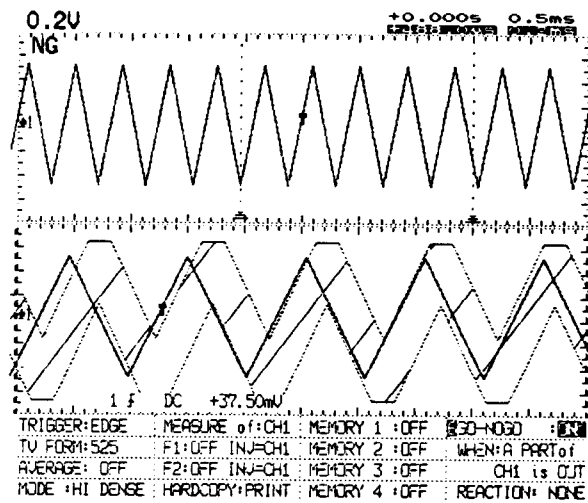

### Execution command menu of GO-NOGO judgment function

In the above figure,

GO-NOGO: ON ..... The GO-NOGO judgment function is executed.

GO-NOGO: OFF .... The GO-NOGO judgment function ends, and the normal operation mode is established.

#### Caution

1. The signal delivered by the GO-NOGO judgment function is an open-collector output. It is recommended to receive the output signal by the circuit as illustrated in Fig. 6-56.

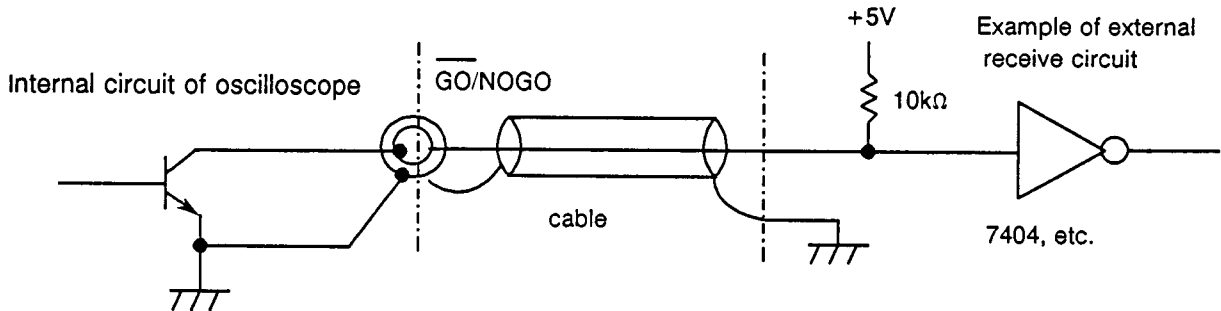

Fig. 6-56

The voltage and current applied to this output terminal are as follows.

Do not apply the voltage and current in excess of the rated values to avoid possible damage.

Voltage: 0 to +7V

Max. current: 50mA

2. The level of the signal entered at the output terminal is maintained from the end of judgment to the end of the next judgment. Though this period changes according to the period of the trigger signal and the number of judged data, it is approximately 100ms when NONE is selected as the processing required after judgment. If some processing is selected, the time required for the processing is added.



3. When PRINT is selected as the processing required after judgment, judgment continues to be performed even after a hard copy of the screen data has been produced.  
Unless the GO-NOGO function is turned off by using the page menu, the judgment function continues to work even if printing paper in the built-in printer becomes absent. However, if the printer is operated with paper absent, it may be defective.  
Be careful that printing paper does not go.
4. When H MODE is ALT, the edit of the judgment area and the GO-NOGO judgment are performed for the magnified waveform or the specified one segment waveform. When ZOOM is set to DUAL, the magnified waveform selected by SELECT (third row of page menu page B) is processed.

## 6.16 Save and recall of setup data (SETUP SAVE/RECALL)

<Recall of saved panel setup data to measure under the same conditions>

**Functional description** Up to 10 sets of setup data can be saved to the built-in IC memory. The saved data can be recalled at any time to perform measurements under the same conditions. As the saved data is battery-backed up, it is retained after power off.

**Operation** (1) **How to save setup data**

Press the SETUP SAVE key of the STORAGE section.

Ten sets of setup memories are numbered from #1 to #10.

When the SETUP SAVE key is pressed first, the message "Saved to setup #1" is displayed and the setup data is saved to memory #1.

Later, each pressing the SETUP SAVE key counts up a save memory number to save the setup data in succession.

SETUP  
SAVE



(2) **How to recall setup data**

Press the SETUP RECALL key of the STORAGE section to recall the setup data from the setup memories.

When the setup data is recalled from the memory (for example, memory #1), the message "Recalled setup #1" is displayed.

The recalled setup data is set to this instrument and measurements can be performed under the same conditions as the saved data.

When the memory to which setup data is not saved is recalled, the message "Could not recall setup #1" is displayed and the setup data saved before pressing this key is retained. In this case, pressing this key counts down the memory number.

SETUP  
RECALL



(3) **How to save setup data to the desired memory**

Press the SETUP SAVE key, first, and then press the desired setup memory number (for example, 6) on the numeric pad while the message "Ten key Available" is being displayed.

Then, the message "Save to setup #6" is displayed, and the data is saved to memory #6.

(4) **Recalling of the setup data from a specific setup memory**

Press the SETUP RECALL key, first, and then, press the desired setup memory number (for example, 6) while the message "Ten key Available" is being displayed.

Then, the message "Recall setup #6" is displayed and the setup data of memory #6 is set to the instrument.

**Note:** The keys on the numeric pad are common to the operation keys at the STORAGE section, AUTOSAVE section and TRIGGER section. Figures are marked at the right side of the keys of these sections.

## 6.17 Restoration to the settings before shipment

As this instrument has the panel backup function, setup data before power off is retained.

To restore the settings before shipment, take the following procedure.

### Operation

Use page 9 of the page menu.

Set the DEFAULT: column from OFF to ON, then the settings before shipment are restored.

### Setup contents before shipment

For the setup contents before shipment, see Appendix B.

## 6.18 Waveform save function (WAVEFORM SAVE/RECALL)

< Save of waveform data to built-in memory and IC memory card >

### Functional description

The waveform data (CH1-CH4) (CH1, CH2 for the VC-7502) displayed on the screen can be saved to the built-in backup memory or the IC memory card. The saved data can be recalled and displayed on the screen.

Two waveform save functions are available: picture data (PIXEL) save function and waveform data (UBYTE) save function. Each function has the features as described below.

#### (1) Picture data save function(PIXEL)

- ① Memory: Built-in backup memory/IC memory card
- ② Features: As the waveform data displayed on the screen can be saved as is, this function is convenient to save overwritten waveforms and operated waveforms.  
However, it is impossible to discriminate a waveform in the recalled screen data.

#### (2) Waveform data save function(UBYTE)

- ① Memory: IC memory card only
- ② Features: As the newest waveform of each channel displayed on the screen can be saved as an independent data, this function is convenient to analyze/process waveform data, using a personal computer.

### Operation

#### (1) Selection of memory

With the waveform save function, the built-in backup memory and the IC memory card can be used. When the IC memory card is inserted into the slot, the IC memory card automatically saves data. When the IC memory card is not inserted, the built-in backup memory is automatically used.

#### (2) Waveform save to built-in backup memory

When the built-in backup memory is used, only the picture data save is effective and the waveform data save is invalid. The built-in backup memory saves the data of only one screen. Therefore, if waveforms are saved to the built-in backup memory repeatedly, the previous data is cleared in succession and only the newest screen data is saved.

### WAVEFORM SAVE



#### < How to save waveform to built-in backup memory >

- ① Remove the IC memory card.
- ② Press the WAVEFORM SAVE key on the panel. Then, the screen data is saved to the built-in backup memory, and the message "Saved to pixel memory" is displayed on the screen.

### WAVEFORM RECALL



#### < How to recall waveform from built-in backup memory >

- ① Remove the IC memory card.
- ② Press the WAVEFORM RECALL key on the panel. Then, the screen data is recalled from the built-in backup memory, and the message "Recalled from pixel memory" is displayed.

#### < How to clear recalled waveform >

- ① Select the recall display switch "MEMORY1:ON" of the fixed menu (1 lines, 3 columns).
- ② Rotate the VARIABLES knob or press the ENTER key to set to "MEMORY1:OFF".

Thus, the recalled waveform can be cleared.

When the built-in backup memory is used, the recall display switches MEMORY2-MEMORY4 are invalid.

### (3) Waveform save to IC memory card

When the IC memory card is used, the picture data save or the waveform data save can be selected. It is needed to format the IC memory card to clear all previous data or when it is used first. The IC memory card formatted by this instrument is of the MS-DOS format, and data can be written or read directly by a personal computer.

#### < Handling considerations of IC memory card >

- ① When the file of the specified file name is not present, a new file is created, and
- ② When the file of the specified file name is present, the contents of the file are cleared and the file saves data as a new file.

Therefore, when the message "Card Full" is displayed, save data by the following procedure.

- ① Prepare an IC card which has full capacity, or format the IC memory card to which the message "Card Full" is displayed.
- ② Specify the file name of the file whose capacity is greater than the capacity of the waveform to be saved, and save data.
- ③ Clear the file not necessary by a personal computer provided with a slot for an IC memory card to ensure a full capacity; then save data.

The capacities as listed in table 6-5 are required.

Table 6-5

Type	Waveform data length	Minimum capacity
UBYTE	512	1kbyte
	8k	9kbyte
	2048k(VC-7524 only)	2049kbyte
PIXEL	—	17kbyte

#### < Preparation of IC memory card >

SRAM cards of JEIDA Ver. 4.0 of 64kbyte to 4Mbyte can be used, and other IC cards cannot be used.

- ① Check that an IC card is usable.
- ② Install a battery for backup to the IC card.  
If a battery is not available, the card may not be used.
- ③ Release the write protection of the IC memory card.  
If the write protection is applied, the IC memory card cannot be formatted.
- ④ Insert the IC memory card to the slot.  
If the IC memory card is not inserted correctly, the card cannot be formatted.
- ⑤ Select the size of the IC memory card at the first line on page 2 of the page menu.

If the selected size is larger than the actual size, the card may not be formatted or the saved data may be destroyed.

Be sure to select the correct size.

- ⑥ Format the IC memory card.  
Select FORMAT: END, and rotate the VARIABLES control or press the ENTER key, then, FORMAT: START is displayed and "Push ENTER to Format" is

displayed above left of the scale. Press the ENTER key to start formatting. Press any other key to stop formatting.

Then, FORMAT:START is displayed and formatting starts. When formatting ends, the message "...kB Format Successful" is displayed on the screen.

#### < How to save data to IC memory card >

- ① Insert the formatted IC memory card into the slot.
- ② Select FILE type at the third line on page 2 of the page menu.  
Select PIXEL to save screen data and UBYTE to save waveform data.
- ③ Select FILE No. at the fourth line on page 2 of the page menu.  
A file No. can be selected from 1 up to 9999 and the selected number is numbered to the name of the file to which data has been saved.

**WAVEFORM  
SAVE**



- ④ Press the WAVEFORM SAVE key.
  - 1) In case of the picture data (PIXEL) save, the screen data can be saved to the IC memory card with the file name " WAVE xxx. PXL".
  - 2) In case of the waveform data (UBYTE) save, the data of the channels whose DISPLAY's are turned ON are saved to the IC memory card with the file name "WAVE xxxx. DAT".

FILE No. is incremented to the number of the saved files.

To specify the desired memory number, press the WAVEFORM SAVE key, first, and press the desired number key on the numeric pad while the message "Ten key Available" is being displayed.

Then, press the ENTER key.

#### < How to recall data from IC memory card >

- ① Insert the IC memory card to which the waveform data is saved into the slot.
- ② Select FILE TYPE at the third line of page 2 of the page menu.  
Select PIXEL to recall the picture data and UBYTE to recall the waveform data.
- ③ Set the recall display switches of the fixed menus (1line, 3 columns), (2 lines, 3 columns), (3 lines, 3 columns) and (4 lines, 3 columns) to ON.  
At this time, select MEMORY1:ON to recall the picture data (PIXEL).  
To recall the waveform data (UBYTE), select MEMORY1 to MEMORY4 for the waveforms to be displayed on the screen to ON.

- ④ Select FILE No. at the fourth line on page 2 of the page menu.

A file number can be selected from 1 up to 9999.

Check if the file of the desired number is present.

When such file is absent or plural files are required to recall, FILE No. is automatically decremented.

- ⑤ Press the WAVEFORM RECALL key on the panel.
  - 1) In case of the picture data (PIXEL) save, only one specified file named "WAVE xxxx. PXL" is recalled and displayed on the screen.
  - 2) In case of the waveform data (UBYTE) save, the files named "WAVE xxxx. DAT" for which the recall display switches MEMORY1 to MEMORY4 are turned ON are recalled and displayed on the screen.

**WAVEFORM  
RECALL**



To specify the desired memory number, press the WAVEFORM RECALL key, first, and press the desired memory number on the numeric pad while the message "Ten key Available" is being displayed. Then, press the ENTER key.

## < How to clear recalled waveform >

### (1) Using menu

- ① Select the recall display switches (MEMORY1 to MEMORY4) to be cleared by using the fixed menus (1line, 3 columns), (2 lines, 3 columns), (3 lines, 3 columns) and (4 lines, 3 columns).
- ② Rotate the VARIABLES knob to set the switches to OFF; then, the recalled waveforms are cleared.

### (2) Using CLEAR WAVEFORM key

Select RECALL or ALT on the CLEAR:item on page 8 of the page menu, and press the CLEAR WAVEFORM key. Then, the recalled waveforms can be cleared.

(Vertical movement of recalled waveform)

To move the recalled waveform vertically, select "POS" on page 4 of page menu and rotate the VARIABLES control.

(magnification of recalled waveform)

To magnify the recalled waveform vertically, select "VOLT" on page 3 of menu page and rotate the VARIABLES control.

**Note:** When the recalled waveform is moved or magnified vertically, the original data is not updated. When the data is recalled again, the same waveform as moved or magnified vertically is not displayed. When any waveform is not recalled, "\*\*\*\*\*" is displayed.

**Note:** For horizontal movement or magnification of a waveform, see 6.5 (3) Horizontal magnification and horizontal movement.

## < Header formats of UBYTE file >

When UBYTE is selected, the header formats are as listed below.

```
DATASET HITACHI
VERSION 1
SIGNAL WAVE1
DATE 01-01-1992
TIME 00:00:00.00
FILE_ TYPE UBYTE
NUM_ SAMPS 512
INTERVAL 1e-07
VERT_ UNITS 0.15625 Volts
HORZ_ UNITS Sec
COMMENT HORZ_ OFFSET 9e-07, VERT_ OFFSET 4. 0625, VERT_ INTERVAL
0.15625
COMMENT Signal acquired by Channel 3 of Hitachi VC-7504
DATA
```

The above formats are compatible with the software "DADiSP™" by DSP.

The contents of the header files are as follows

DATASET	'HITACHI' fixed
VERSION	'1' fixed
SIGNAL	Same as file name
DATE	Collected data
TIME	Collected time
FILE-TYPE	'UBYTE' fixed
NUM-SAMPS	Number of data
INTERVAL	Interval of sampling
VERT_ UNITS	Range/32 volts

HORZ-UNITS 'Sec' fixed  
COMMENT Information to recall data by this instrument.  
(i) HORZ-OFFSET ... Delay value at the head of data  
(ii) VERT- OFFSET .... Offset value  
(iii) VERT- INTERVAL .. Range/32  
COMMENT Indicates the channel from which data is acquired.  
DATA Provided at the head of waveform data

**Caution**

1. When the IC memory card is used, the messages as listed below may be displayed.

(1) IC Card No Battery	A battery is not installed in the IC memory card. In this case, the saved data cannot be retained.
(2) IC Card Low Battery	The battery voltage is lowered. In this case, the saved data will be retained for a short period. Replace the battery.
(3) No Card	An IC memory card is not inserted.
(4) Write Protect Error	Displayed when data is written to write protected IC memory card. Release write protection.
(5) Wrong Card	An IC memory card is not formatted or data is destroyed.
(6) Card Full	The capacity of the IC memory card is full, and data cannot be written.
(7) Directory Full	The number of files is too many to create files.
(8) File Not Find	The file of the specified FILE TYPE is absent.
(9) Memory Sw off	All the recall display switches are OFF.
(10) All Channel off	All the channels are OFF.
2. When H MODE is ALT, the magnified waveform is saved by the UBYTE save.
3. When the acquisition mode is SPLIT and H MODE is A, the UBYTE save saves one-split data to one file, and all the split data are saved to the respective files.



## 6.19 How to use built-in printer (PRINT)

< A hard copy of the data displayed on the screen is available using the built-in printer >

### Functional description

This instrument has the built-in serial line printer.

With this printer, a hard copy of the data displayed on the screen can be simply produced.

### Recording paper loading and replacement

One roll of recording paper is supplied as an accessory.

Load this recording paper to the printer.

- (1) Trim the tip of recording paper as shown in (a).

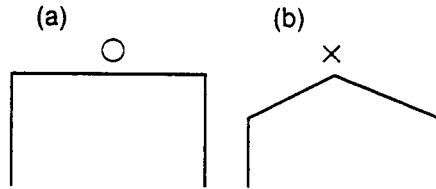

Fig. 6-58

- (2) Open the upper cover of the printer case.

Push the release lever to feed the paper in the HEAD UP mode.

Remove the shaft in the case and insert it into the tube of the recording paper.

Then, load the paper in the case so that the tip of the paper is fed from the bottom of the roll to the printer as shown in below.

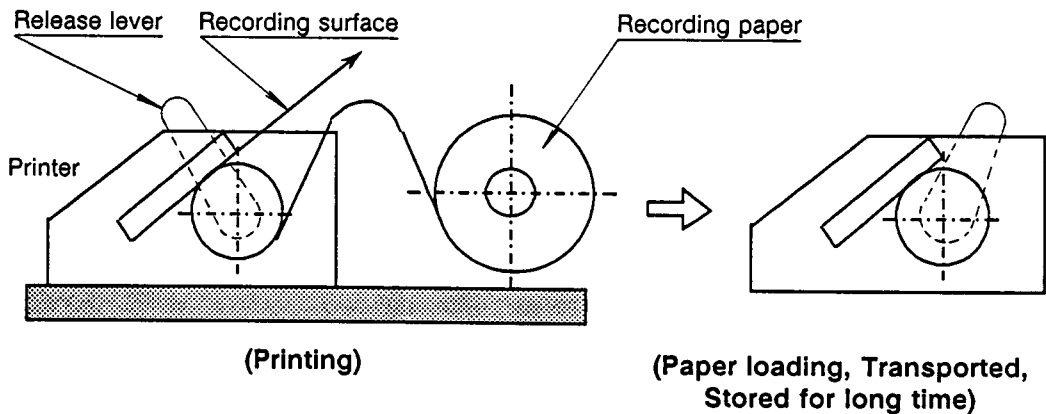

Fig. 6-59

- (3) Insert the tip of the paper appropriately into the paper insertion section of the printer until it appears from the top of the printer.  
Then, pull the tip of the paper to check proper loading, and pull the release lever for the HEAD DOWN mode.
- (4) Feed the tip of the paper into the slit of the upper cover, and close the upper cover.  
Then, pull the tip of the paper slightly to check that the paper is not distorted or slacken.

## Operation

### (1) Setting of hard copy device (Fixed menu: 4 lines, 2 columns)

Prior to using the built-in printer, set the hard copy device to the printer. Set as follows, using the fixed menu (4 lines, 2 columns)

HARDCOPY: PRINT

### (2) Printing

## HARDCOPY

Pressing the HARDCOPY key on the front panel starts printing.

When the HARDCOPY key is pressed again during printing, printing stops.

### (3) Paper feed

When printing ends, the recording paper is automatically fed.

If more length is required, press the feed key on the printer case, as necessary, each time when one printing is over.

## Cautions

### (1) Recording paper

Be sure to use the specified recording paper.

Thermal recording paper: Jujo Paper Co. , Ltd.

Type TF50KS-E2

If the paper not specified is used, printing quality and life of the printer may be affected.

### (2) Storage of recording paper

Store recording paper in a dark place where temperature is below 30°C and humidity is below 60%.

Recording paper will be faded by direct sunlight, non-volatile alcohol (paste on tape), ester erasure, etc. Further, recording paper is colored when it is exposed to high temperature or volatile organic solvent.

Therefore, it is recommended to duplicate data, using a copying machine, to store it without being faded.

- (3) When the printer is operated with recording paper not loaded, the printer head is worn, resulting in degrading printing quality. Prior to operation of the printer, be sure to check that recording paper is loaded.
- (4) When the printer is operated with condensation generated, the printer head can be damaged.  
If condensation is observed, do not attempt to operate the printer until condensation disappears completely.
- (5) When the printer is transported or stored for a long time, set it the HEAD UP mode to avoid possible uneven printing in the future.

## 6.20 Plot output function (PLOT)

<A hard copy of the data displayed on the screen is available, using an external X-Y plotter.>

### Functional description

The information related to the waveform displayed on the screen can be output only by connecting an X-Y plotter to this instrument. The UBYTE save waveform recalled from an IC memory card can be plotted. The other recalled waveforms cannot be plotted.

### Usable plotters

- (1) In case of RS-232C interface  
 Hitachi graph plotter HG-730  
 681-XA  
 or equivalent
- (2) In case of GPIB interface  
 Hitachi graph plotter HG-730 (with GPIB option)  
 Hewlett-Packard 7440A  
 or equivalent

### Connection

#### (1) In case of RS-232C interface

Connect the RS-232C connector on the rear and an X-Y plotter with the RS-232C cable.

The pin arrangement of the RS-232C connector of this instrument is shown under Section 7.1.

There are various types of plotters and their interfaces are different. When using a plotter, read its manual and check the interface cable to be used.

Fig. 6-60 illustrates an example of the wiring or the RS-232C cable used for connection of this instrument and the Hitachi graph plotter 681-XA.

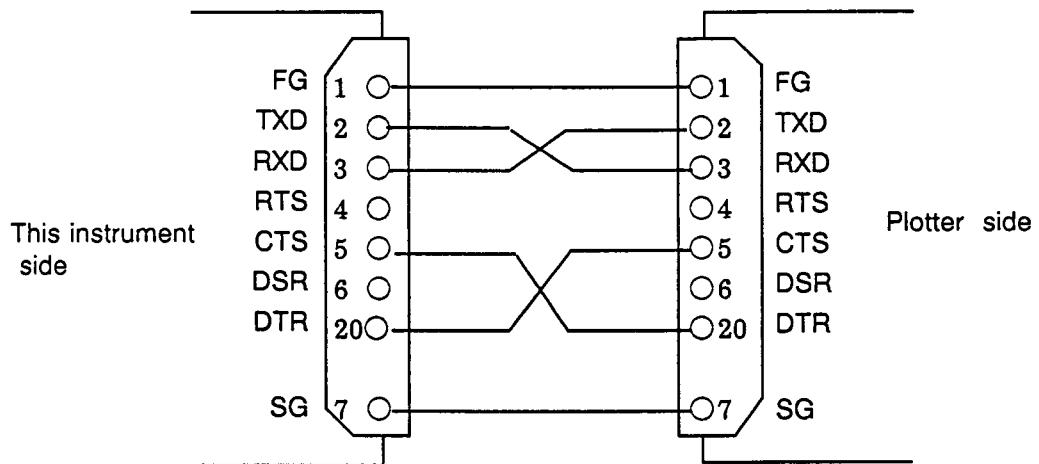
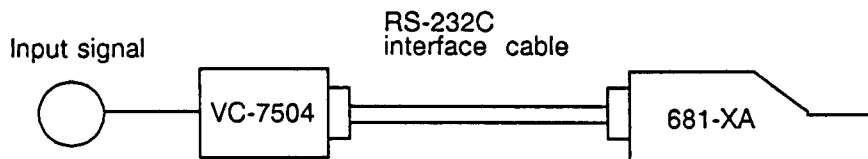

Fig. 6-60 Wiring diagram of RS-232C cable



Note: The RS-232C cable for Hitachi plotter 681-XA: No. 4287 (option)

Fig. 6-61

## (2) In case of GPIB interface

Connect the GPIB connector on the rear and an X-Y plotter with the GPIB cable.

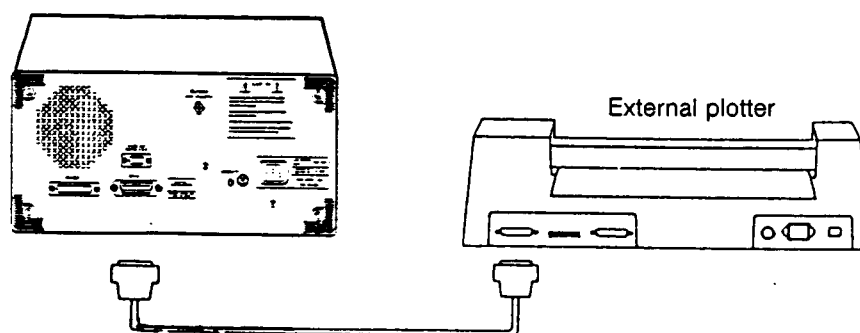

**Note:** GPIB cable: No. 4274 (option)

**Fig. 6-62**

## Hardware setting

Perform the settings related to the hardware according to menus.

Perform the settings of the X-Y plotter to be connected to this instrument corresponding to the specifications and settings of this instrument. For this purpose, refer to the applicable manual of the plotter.

### (1) Setting of hard copy device (Fixed menu: 4 lines, 2 columns)

Set the hard copy device to plotter, using the menu (4 lines, 2 columns) of the fixed menu section. HARDCOPY: PLOT

### (2) Selection of interface (First line on page 8 of page menu)

Set the used interface on page 6 of the page menu section.

INTERFACE: 232C Set when the RS-232C interface is used.

INTERFACE: GPIB Set when the GPIB interface is used.

### (3) Setting of GPIB mode (Second line on page 8 of page menu)

This setting is required only when the GPIB interface is used.

Set according to the used system.

MODE: TALKONLY Specify this when one plotter is used with one instrument.

MODE: ADDRESSED Specify this when the system including a controller is used.

### (4) Setting of GPIB address (Third line on page 8 of page menu)

This setting is required only when the GPIB interface is used.

Specify the address of this instrument when the ADDRESS GPIB mode is established.

### (5) Setting of EOI (Fourth line on page 8 of page menu)

This setting is required only when the GPIB interface is used.

Set whether or not the EOI signal is generated at the end of the protocol of the GPIB interface.

Refer to the operation manual of the plotter. If any specification is not mode, set to ON.

Set to EOI: ON (When setting at the plotter side is not specified)

**(6) Setting of baud rate** (Second line on page 8 of page menu)

This setting is required only when the RS-232C interface is used.

Set the communication baud rate of the RS-232C to that of the used plotter.

Set BAUD RATE to 300, 600, 1200, 2400, 4800, or 9600.

**(7) Setting of stop bit** (Third line on page 8 of page menu)

This setting is required only when the RS-232C interface is used.

Set the stop bit of the communication format of the RS-232C to that of the used plotter.

STOP BIT: 1, 2

**(8) Setting of parity bit** (Fourth line on page 8 of page menu)

This setting is required only when the RS-232C interface is used.

Set the parity bit of the communication format of the RS-232C to that of the used plotter.

PARITY: NONE, ODD, EVEN

## Setting of plot mode

**(1) Setting of paper size, plot size and plot position**

This plotter can plot data on A4 or A3 size paper.

Table 6-6 shows the relationship between the sizes of usable paper and the plottable size per plotting operation.

Any of the plotting formats shown in Table 6-6 can be done by performing the following settings.

**(a) Setting of size** (Second line on page 5 of page menu)

SIZE: Ai on Aj: Set A3, A4, A5 or A6 for Ai, and A3 or A4 for Aj.

Then, select one mode from Table 6-5 .

**(b) Setting of plot position** (Third line on page 5 of page menu)

POSITION: Select AUTO or one figure from 1 thru 8.

① In case of AUTO

Plotting is performed on the plot positions from 1 to 8 in sequence as shown in Table 6-6 .

② In case of 1 thru 8

Plotting is performed on the specified plot position.

**Table 6-6 Plot sizes, paper sizes and plot positions**

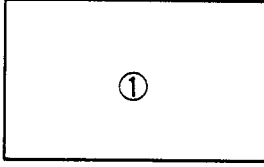
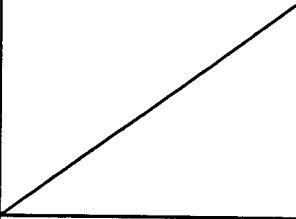
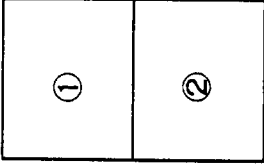
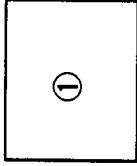
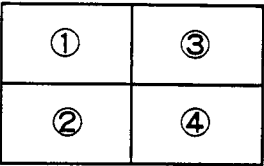
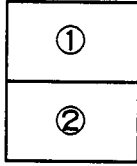
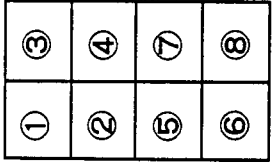
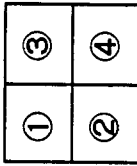
Plot size \ Paper size	A3	A4
A3		
A4		
A5		
A6		

**(2) Setting of pen change mode** (Fourth line on page 5 of page menu)

Set whether or not to change a pen (i.e., change of color) according to be kinds of data.

**PEN CHANGE:ON :** Pens are changed according to the kinds of data (see Table 6-7 ).

**OFF:** Pens are not changed only when a pen No. 1 is used.

When PEN CHANGE:ON is selected, six kinds of colors are usable.

**Note:** When the number of pens of the plotter in use is 5 or less, the corresponding pen numbers are different from plotter to plotter.

**Table 6-7 Plotter data and pen number**

Plotted data		Pen No.
GRATICULE	Grid, scale	1
	T cursor	1
	V, + cursor	1
WAVEFORM (*2)	CH1, MEMORY1	3
	CH2, MEMORY2	4
	CH3(Not provided for the VC-7502), MEMORY3	5 (1) (*1)
	CH4(Not provided for the VC-7502), MEMORY4	6 (2) (*1)
	FUNCTION 1	3
	FUNCTION 2	4
FACTORS	Vertical information	Number corresponding to specified channel
	Horizontal information	Number corresponding to specified channel 1, 2 and 3 for VC-7524
	Waveform parameters	Number corresponding to specified channel
	T cursor measurement value	1
	V, + cursor measurement value	Number corresponding to specified channel

} Specified channel and corresponding pen No.

(\*1) ( ) indicates the pen number when the Hitachi graph plotter 681-XA is used.

(\*2) The UBYTE save waveform recalled from an IC memory card can be plotted. The other recalled waveforms cannot be plotted.

**(3) Selection of data** (First line on page 5 of page menu)

Select the data to be plotted.

- PLOT: ALL                      Plots all information.
- PLOT: WAVEFORM              Plots waveform data only.
- PLOT: GRATICULE              Plots grid, scale and cursors.
- PLOT: FACTORS                Plots set values and measured data.

**Execution of plotting**

Check that the connections and settings described above are performed appropriately.



Check that recording paper and pens are loaded appropriately.  
Press the **HARDCOPY** key on the front panel, then, plotting starts.

**(Note 1)** When the **HARDCOPY** key is pressed again during plotting, plotting is interrupted.

The time needed to stop plotting after the **HARDCOPY** key has been pressed is changed from plotter to plotter.

**(Note 2)** The keys other than the **HARDCOPY** key are invalid during plotting.

### **Cautions**

(1) Setting of plotter using the RS-232C interface

The data format of this instrument for the RS-232C interface is fixed to:

START BIT + 8BIT + 2STOP BIT

Set the plotter side to the above.

(2) Delimiters are not added in the plot output mode.

(3) This instrument is provided with both the RS-232C and GPIB interfaces as standard. Therefore, the control by a personal computer and the data transfer between the personal computer and this instrument are performed.

These communications functions cannot be used together with the output function of the X-Y plotter.

While the communications functions are being used, do not execute the output function (plot output by the **HARDCOPY** key) of this instrument.

### **Major causes of trouble**

In case plotting is not performed correctly, check the following items.

(1) Check if cables are connected correctly and securely.

(2) Check if the X-Y plotter is turned on.

(3) Check if the X-Y plotter is in the error mode.

(See the operation manual of the X-Y plotter.)

(4) Check if the baud rate and data format of this instrument conform to those of the X-Y plotter.

(5) Check if the interface cable is correct.

### **When plotting is Interrupted**

Prior to starting plotting, this instrument sends the initialization commands ("ESC.K" and "ESC. R") of the X-Yplotter to prevent erroneous operation.

In case such an X-Y plotter as does not accept these commands is used, it may operate erroneously. When plotting is interrupted, initialize the X-Y plotter by turning off the power of the X-Y plotter and turning on the power again. Then, execute the next plotting.

**Note:** Be sure to use an X-Y plotter for which the HP-GL\* commands can be used.

\*HP-GL: Registered Trademark of Hewlett-Packard



## 6.21 Clock function

<Recording of data and time together with waveform data>

### Functional description

This instrument has the built-in clock function.

This clock function can be used in the following operations.

- ① When the time setting menu is opened, the time when the menu is opened is displayed in the menu.
- ② When the data displayed on the screen is plotted, the time when plotting is made is also plotted.
- ③ When data is plotted from an external X-Y plotter, the time when plotting is performed is also plotted.
- ④ Waveform data is saved to an IC memory card, the time is also saved.

### Setting procedure (Fourth line on page 7 of page menu)

#### (1) Check of time of internal clock

The time setting menu is provided on the fourth line on page 7 of the page menu. When this menu is opened, the time is displayed.

The time is displayed like OCT-17-92 15:28.

This indicates month-day-year (last two digits) and hour:minute.

**Note:** The displayed time is not updated if the menu is opened continuously. To check the current time, close the menu once, and open it again.

#### (2) Setting of time

When the time of the internal clock is not correct, set the figures in the menu to the correct time. Then, the time is set to the internal clock.

# CHAPTER 7 INPUT-OUTPUT INTERFACE

## 7.1 RS-232C

### (1) General

The RS-232C is the serial communication interface standardized by the Electronic Industries Association in the United States of America. This instrument can transmit and receive digital data through the RS-232C interface.

### (2) Specifications

- |                          |   |   |
|--------------------------|---|---|
| ① Electrical             | : | Conforms to the EIA RS-232C.            |
| ② Type of transmission   | : | Asynchronous                            |
| ③ Length of stop bit     | : | 1bit or 2 bits                          |
| ④ Character length       | : | 8 bits                                  |
| ⑤ Parity bit             | : | NONE/ODD/EVEN                           |
| ⑥ Delimiter              | : | C/R L/F                                 |
| ⑦ Transmission rate      | : | 300, 600, 1200, 2400, 4800 or 9600 baud |
| ⑧ Communication protocol | : | Hard wired handshake                    |

### (3) Connector Pin Arrangement and Signal Description

- ① Fig. 7-1 illustrates the pin arrangement of the RS-232C connector, and Table 7-1 lists the pin functions.

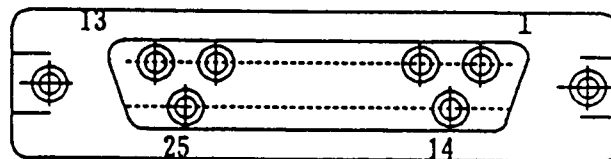

Fig. 7-1 Pin arrangement

**NOTE:** Connector DB-25P (female) applicable for connection cable is used.

**Table 7-1 Terminals of the RS-232C connector**

Pin No	Signal	Function	Direction of signal
1	FG (AA)	Frame GND	
2	TXD (BA)	Transmit Data	OUT
3	RXD (BB)	Receive Data	IN
4	RTS (CA)	Request To Send	OUT
5	CTS (CB)	Clear To Send	IN
6	NC	NON CONNECT	
7	SG (AB)	SIGNAL GND	
8	NC	NON CONNECT	
9	↑	↑	
10			
11			
12			
13			
14			
15			
16			
17			
18	↓	↓	
19	NC	NON CONNECT	
20	DTR(CD)	Data Terminal Ready	OUT
21	NC	NON CONNECT	
22	↑	↑	
23			
24	↓	↓	
25	NC	NON CONNECT	

② Each signal of the RS-232C interface is described below.

- Ⓐ FG: Frame Ground  
Ground line for chassis
- Ⓑ TXD: Transmit Data  
Transmit data output signal  
Normally in the mark state \*1
- Ⓒ RXD: Receive Data  
Receive data input signal  
Normally in the mark state \*1
- Ⓓ RTS: Request To Send  
This output signal indicates the request-to-send state.  
This signal is used to control the transmission function of data transfer at the modem transmission section.  
"0" (space): Carrier transmission request  
"1" (mark): Carrier stop request
- Ⓔ CTS: Clear To Send  
This input signal controls the modem transmission section  
This signal becomes in the mark state when the modem transmission section is in the Clear-To-Send state.
- Ⓕ SG: Signal Ground  
Ground line for signal  
  
\*1 -9 V level --- "0" (space), +9 V level --- "1" (mark)
- Ⓖ DTR: Data Terminal Ready  
This input signal controls the modem transmission.  
This signal becomes in the mark state when the modem transmission and reception section is in the send and receive state.  
This signal line is connected when plotter use, does not need to connect this signal line when personal computer use.

#### (4) Connection

Connect the instrument with a personal computer by the RS-232C interface cable. Prior to connection of a personal computer, read the related manual carefully and use the appropriate interface cable, because interface is changed in accordance with types of personal computers.

Fig. 7-2 illustrates the wiring of the RS-232C interface cable used for the connection of the Hitachi personal computer B-16 and the instrument.

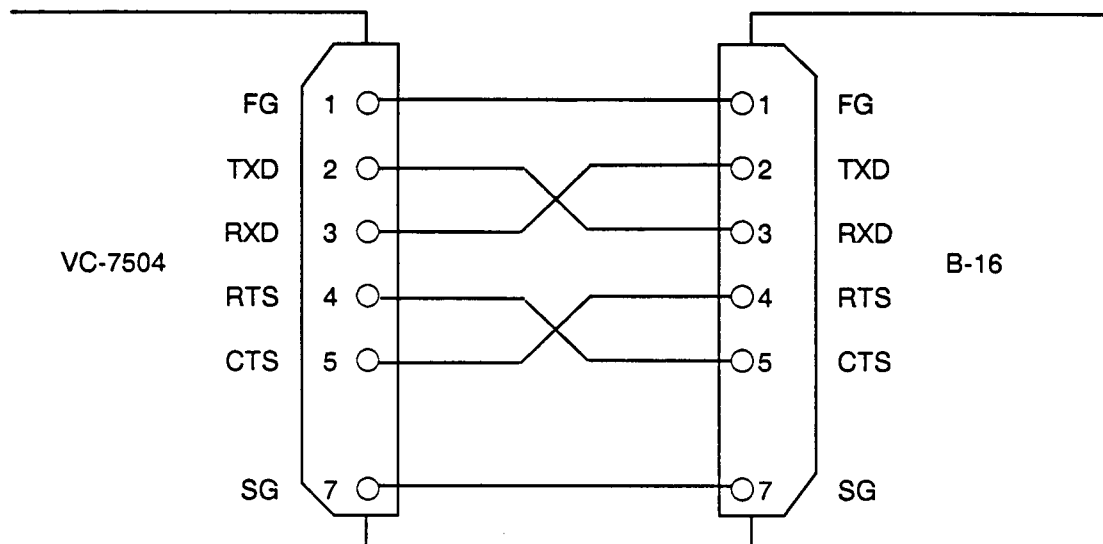

**Fig. 7-2 Wiring diagram of the RS-232C interface cable**

**NOTE:** RS-232C cable for the personal computer: No.4290 (option)

## 7.2 GPIB

### ● Introduction

The GPIB is a general purpose interface bus which conforms to the IEEE-488 (1978) GPIB standards, which provides an interface between digital data equipment by using exclusive connectors and cables.

### ● GPIB System

#### 7.2.1 General

The GPIB is used for transmitting and receiving data of different transfer rates between self-contained instruments or devices and the GPIB can support up to 15 independent devices connected in parallel.

Data transmission instructions between the instrument and other independent devices such as a personal computer via the GPIB are described in this manual.

Fig. 7-3 shows a typical system using the GPIB.

While only four instruments are shown, the GPIB can support up to 15 independent devices connected directly to the bus.

GPIB system equipment functions are classified into the three following classes: talker, listener and controller.

During interface system operation, the connected equipment operates in one of the corresponding GPIB system functions.

A talker is an instrument that can send data to one or more listeners, while a listener is an instrument that can accept data from the talker. A controller is an instrument that determines which of the instruments of on a bus will talk and which instruments will listen during any given time interval.

The controller also has the ability to assign itself as either a talker or a listener, whenever the program routine requires.

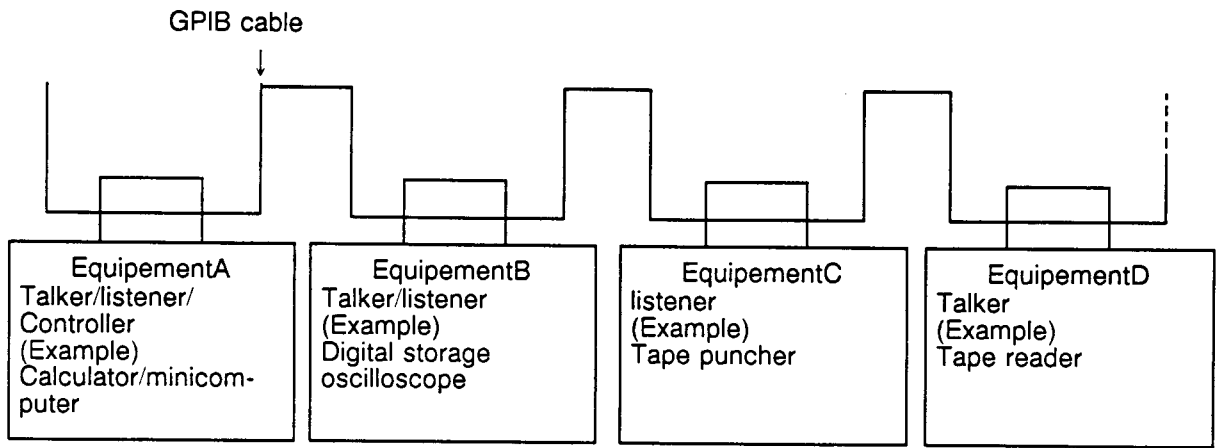

Fig. 7-3 A typical system using the GPIB

## 7.2.2 Specifications

### (1) Message paths and bus structure

Fig. 7-4 shows the 16 signal lines of the GPIB functionally divided into three component buses: an eight-line data transfer bus, a three-line handshake control bus and a five-wire management bus.

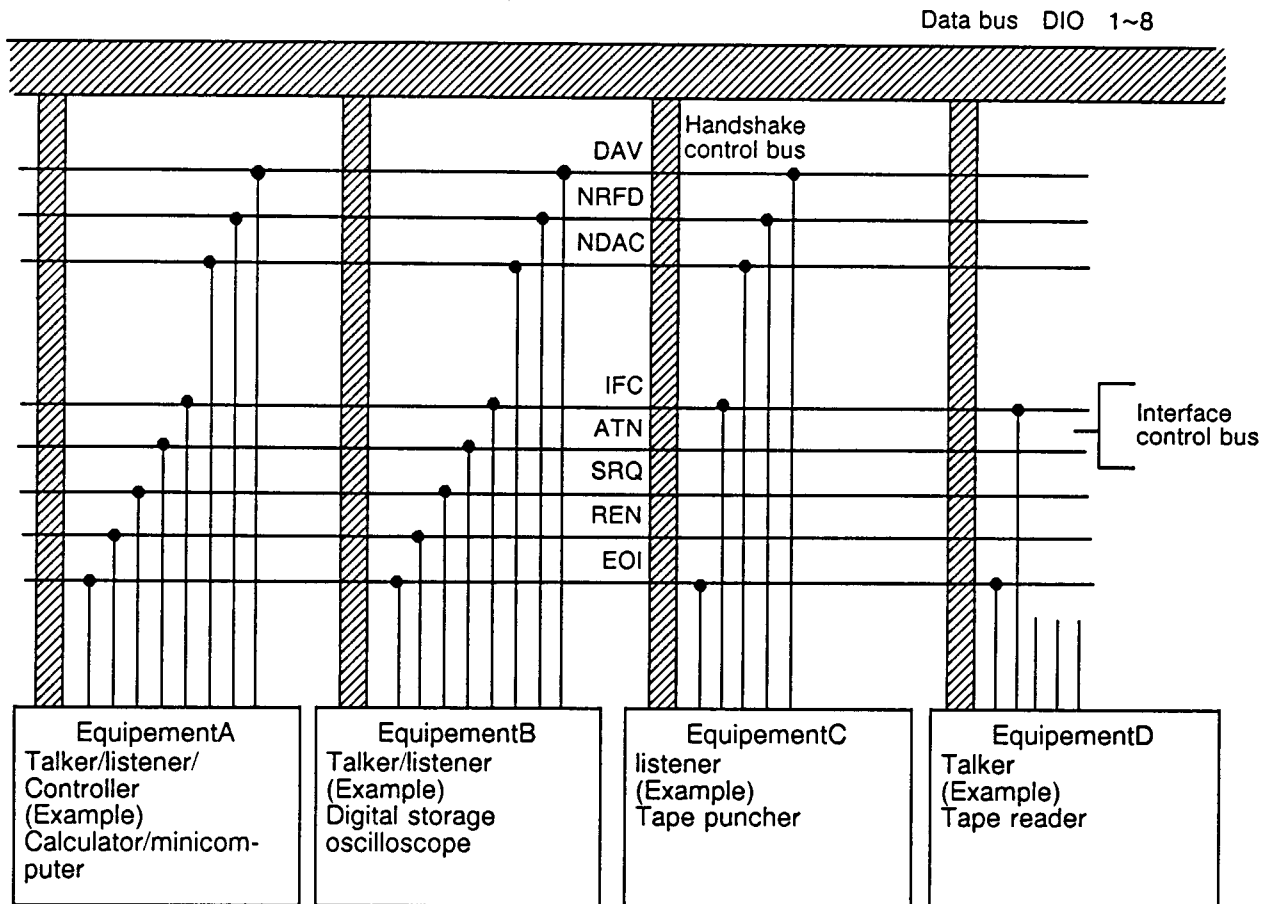

Fig. 7-4 GPIB structure

## (i) Handshake control bus

### DAV: Data Valid

Asserts that data on the data bus is valid.

\_\_\_\_\_When DAV is LOW: Data is valid for the listener.

\_\_\_\_\_When DAV is HIGH: Data is invalid for the listener.

### NRFD: Not Ready For Data

A HIGH NRFD indicates that all the assigned listeners are ready to receive the next data byte from the talker.

LOW NRFD: Not ready to receive data.

### NDAC: Not Data Accepted

A HIGH NDAC indicates that all assigned listeners have accepted the current data.

LOW NDAC: Does not have accepted the current data

(The taker will control data bus and DAV lines, while the listener controls NRFD and NDAC lines.)

## (ii) Management bus

### IFC: Interface Clear

Only the system controller can generate this IFC signal.

When IFC is LOW for at least 100 $\mu$ s, all interfaces for the talker and the listener are in a quiescent state. Then, the control priority is returned to the controller.

### ATN: AttenTion

Only a controller can generate the ATN signal.

LOW ATN: Establishes command mode.

HIGH ATN: Establishes data mode.

### SRQ: Service RequEst

Any instrument connected to the bus can request the controller's attention by sending the SRQ message. The SRQ message can be set only when IFC is HIGH.

### REN: Remote EnAble

The system controller sends the REN message to an instrument whenever the interface system is operating under remote program control.

### EOI: End Or Identify

A talker can use the EOI message to indicate the end of a data-transfer sequence, or to execute a polling sequence by a controller.

When ATN is HIGH, the talker sends the EOI LOW message to indicate the last byte of data is transmitted.

## (iii) Data bus

### DIO1 to DIO8: Data Input Output

The data bus has eight bidirectional signal lines, DIO1 through DIO8. Information, in the form of data bytes, is transferred over this bus.

A handshake sequence between an enabled talker and the enabled listeners transfers one data byte at a time.

Data bytes in either an interface or device-dependent message are sent in a byte-serial sequence over the data bus.

## (2) GPIB connector and cable

Physical arrangement of the 24-conductor GPIB connector (located on the rear panel) meets the IEEE-488 (1978) GPIB standards.

A contact assignments of the cable connector and the device connector shall be as shown in Fig. 7-5. 16 pins are for signal lines and the remaining 8 pins are for ground.

The voltage and current conform to TTL standard and; the voltage shall be less than +5.5V against GND.

When the voltage is low level of +0.8V or lower, the signal is set to logic "1" in the TRUE mode.

When the voltage is high level of +2V or higher, the signal is set to logic "0" in the FALSE mode.

- a) Total cable length: 20m max (Total of each cable length)
- b) Single cable length: 4m max. (One span connection)
- c) Connectable equipment number: 15 sets max. (Including a controller)

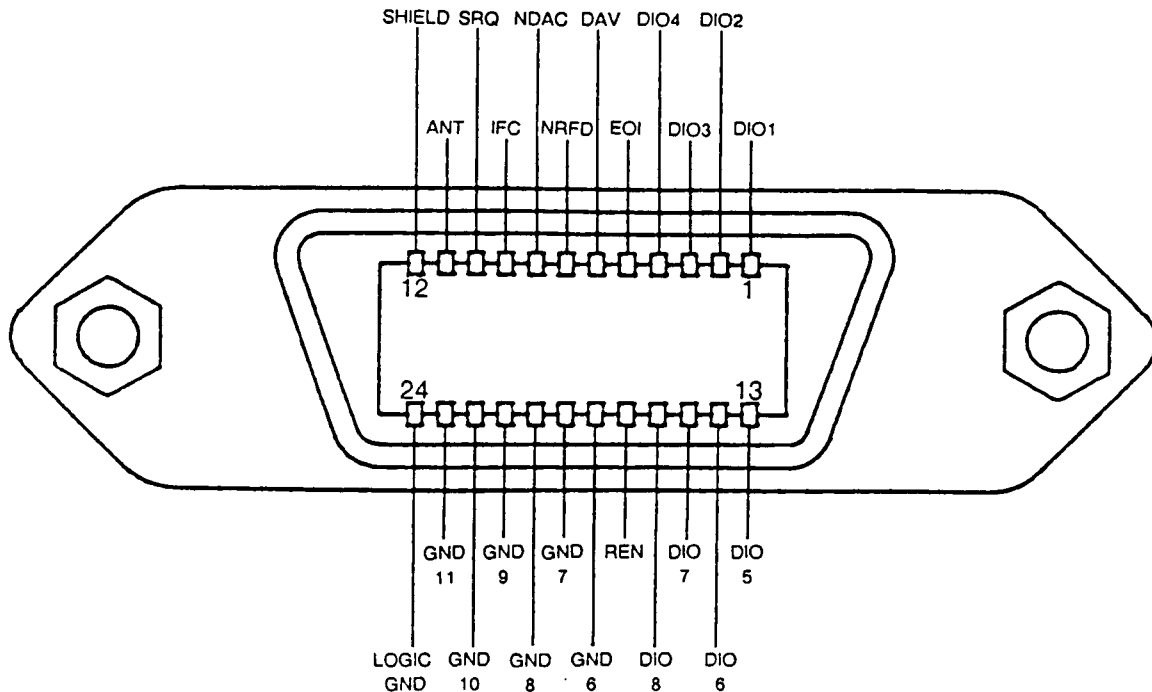

**Fig. 7-5 GPIB interface connector**

Use a double shielded GPIB which especially meets the following conditions in the IEEE-488 (1978) GPIB standards.

### **7.3 VIDEO OUT(output)**

This oscilloscope is provided with the VIDEO OUT output (DIGITAL R. G. B) on the real panel for output to an external monitor.

This connector (D sub type, 9-pin) can be connected to a multiscan type color display (with digital RGB input) applicable to a personal computer made by IBM.



**Table 7-2 Pin connection of VIDEO OUT output connector**

<b>Pin No.</b>	<b>Signal</b>
1	GND
3	R(Red)
4	G(Green)
5	B(Blue)
8	Horizontal (21.80kHz $\pm$ 2%)
9	Vertical (60.06Hz $\pm$ 2%)
2, 6, 7	NC(Not connected)

# CHAPTER 8 PROGRAMMING FUNCTIONS

## 8.1 General of programming functions

### 8.1.1 General

The four basic operations which can be done with a controller and the oscilloscope through the GPIB or RS-232C interface are as follows:

1. Setup the instrument and start measurements.
2. Get setting information and measurement results.
3. Send waveform data to the controller.
4. Send measurement data to the instrument.

Other complex tasks are accomplished by combining these basic functions.

**Note:** Restriction of these functions

Magnification, scroll and V position move process in the HOLD mode cannot be controlled from the controller.

### 8.1.2 Setting instrument

To run the programming functions, set the instrument for the interface to be used.

For selection of the interface to be used and the setting of a protocol, refer to 6.20 setting of hardware.

## 8.2 Programming

### 8.2.1 Functions of interface

The GPIB functions of this oscilloscope are SH1, AH1, T5, L4, SR1, RL0, DC1, DT0, and C0 defined by IEEE488.1.

### 8.2.2 Programming syntax

The description of the program is shown in Fig. 8-1. The program is described in the order of the output command, the file No., the mnemonic header, the mnemonics, the separator, and the program data. These data can be sent to the instrument as character strings of the ASCII system through RS-232C. (Commands are valid only in the long form.)

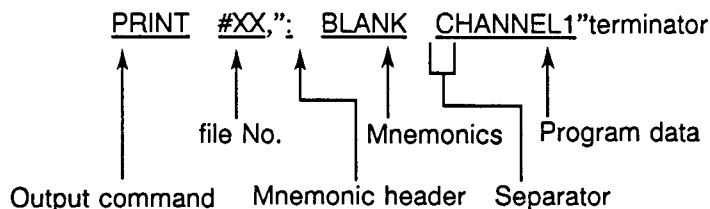

Fig. 8-1 Program format

### **(1) Output command**

The output command varies according to the language of the controller which you use. In the example of each command described in this manual, the Quick Basic is used. When using other languages, find commands equivalent to the Quick Basic commands like PRINT and INPUT in order to convert the program.

### **(2) File number**

The location where the file number must be specified also varies according to the controller language which you use. In Quick Basic, the file No. is always specified after PRINT. The examples in this manual assume the file number of RS-232C is 1.

### **(3) Mnemonic header**

The mnemonics consists of one or more mnemonics separated by colons (:) that represent the operation to be performed by the instrument. Queries are indicated by adding a question mark (?) to the end of the header.

### **(4) Mnemonics**

The mnemonics is a character string specifying the operation of the instrument. For details, refer to section 3.

### **(5) Separator**

The separator is used to separate the mnemonic header and the mnemonics from the program data. If the mnemonic does not require any program data, it is not necessary to include any separator. In this manual, the separator is defined as one or more spaces. ASCII defines a space to be character code 32 (in decimal).

### **(6) Program data**

Program data are used to clarify the meaning of the command or query. The program data provide necessary information on the setting of instrument or which waveform is to be displayed.

### **(7) Terminator**

This oscilloscope recognizes the line feed code or EOI as a terminator. In the return mode, GPIB recognizes the line feed code as a terminator and RS-232C recognizes the carriage return and the line feed code as terminators. ASCII defines the line feed code to be character code 10 (in decimal) and the carriage restart to be character code 13 (in decimal).

## **8.2.3 Setting command syntax**

One command consists of one header, some data and the terminator. The types of headers are described below.

### **(1) Compound command header**

Compound command heads are a combination of plural mnemonics. To analyze a command, select the subsystem and select the function within that subsystem with the mnemonics.

For example, to execute a single function in a subsystem:

:< subsystem > : < function > < separator > < program data > < terminator >

**Example:**

:CHANNEL1:COUPLING AC

This means that the input coupling on channel 1 is set to AC.

A subsystem name, or the like, cannot be omitted for all the commands. Thus, to send two or more commands at a time, separate two complete commands with ";".

:< subsystem > : < function > < separator > < program data > ;  
:< subsystem > : < function > < separator > < program data > < terminator >

**Example:**

:CHANNEL 1:RANGE 100M;;CHANNEL 1:OFFSET 2

This means that the vertical axis range on channel 1 is set to 100mV/div and the offset is set to 2V.

## (2) Common command header

Common command headers control IEEE488.2 functions including the control of status clear, etc. Their syntax is:

\* < command header > < terminator >

No space or separator is allowed between the asterisk (\*) and the command header.

For details of the common command, refer to section 8.3.1 Common command programming grammar.

### 8.2.4 Query command syntax

Commands with a question mark (?) just after the mnemonics are query commands. They are called queries hereinafter.

After receiving a query, the instrument interrogates the requested function and places the answer in its output queue. The answer remains in the output queue until it is read or another command is issued.

When read, the answer is transmitted to the controller through RS-232C.

**Example:**

:TIME BASE:RANGE?

This command feeds the setting of the time base to the queue buffer. When the controller executes LINE INPUT # < file No. >;Range, the setting data is sent to the controller through RS-232C.

**(For reference)**

Concerning the program message, the character strings in the ASCII form can be sent in combination of upper-case and lower-case letters. However, when receiving responses, upper-case letters are used exclusively.

### 8.2.5 Mnemonic of unit

Some command headers require values as data.

For example, a command header can be represented by the following:

**Example:**

:TIMEBASE:RANGE 1E-3

Table 8-1 shows mnemonic of units.

**Note:** For example, 1E-3 represents  $10^{-3}$ .

**Table 8-1 Exponent unit**

<b>Value</b>	<b>Mnemonics</b>	<b>Value</b>	<b>Mnemonics</b>
1E18	EX	1E-3	M
1E15	PE	1E-6	U
1E12	T	1E-9	N
1E9	G	1E-12	P
1E6	MA	1E-15	F
1E3	K	1E-18	A

### **8.2.6 Sending and receiving waveform data**

When sending waveform data as 8-bit binary data through GPIB, blocked fixed-length data can be used. Concerning syntax, the number following the # symbol represents the number of digits in decimal number. Decimal numbers sent following the number represents the number of data bytes. After the numbers, the actual data block follows.

When data of 512 bytes is sent, the syntax is as follows:

#800000512 < data block 512 bytes > < terminator >

"8" means that an 8-digit number follows after the number, and

"00000512" represents the number of bytes of the data block to be sent.

Waveform data has a value of 1 to 255, Zero data represents no data. When there is no data, for example, when the source channel to be returned is off, the data byte count becomes zero and the data block is not returned.

## 8.3 Programming grammar

### 8.3.1 Common command programming grammar

The common commands are defined by the IEEE488.2 standard. These commands are common to all instruments that comply with the IEEE488.4 standard.

The following common commands can be used in this oscilloscope:

command header	command	program data	/query
*CLS	c	-	
*ESE	c/q	-	
*ESR	q	-	
*1DN	q	-	
*LRN	q	-	
*OPC	c/q	-	
*OPT	q	-	
*RCL	c	-	
*RST	c	-	
*SAV	c	-	
*SRE	c/q	-	
*STB	q	-	
*TST	q	-	
*WAI	c	-	

The command syntax of the common commands is described below.

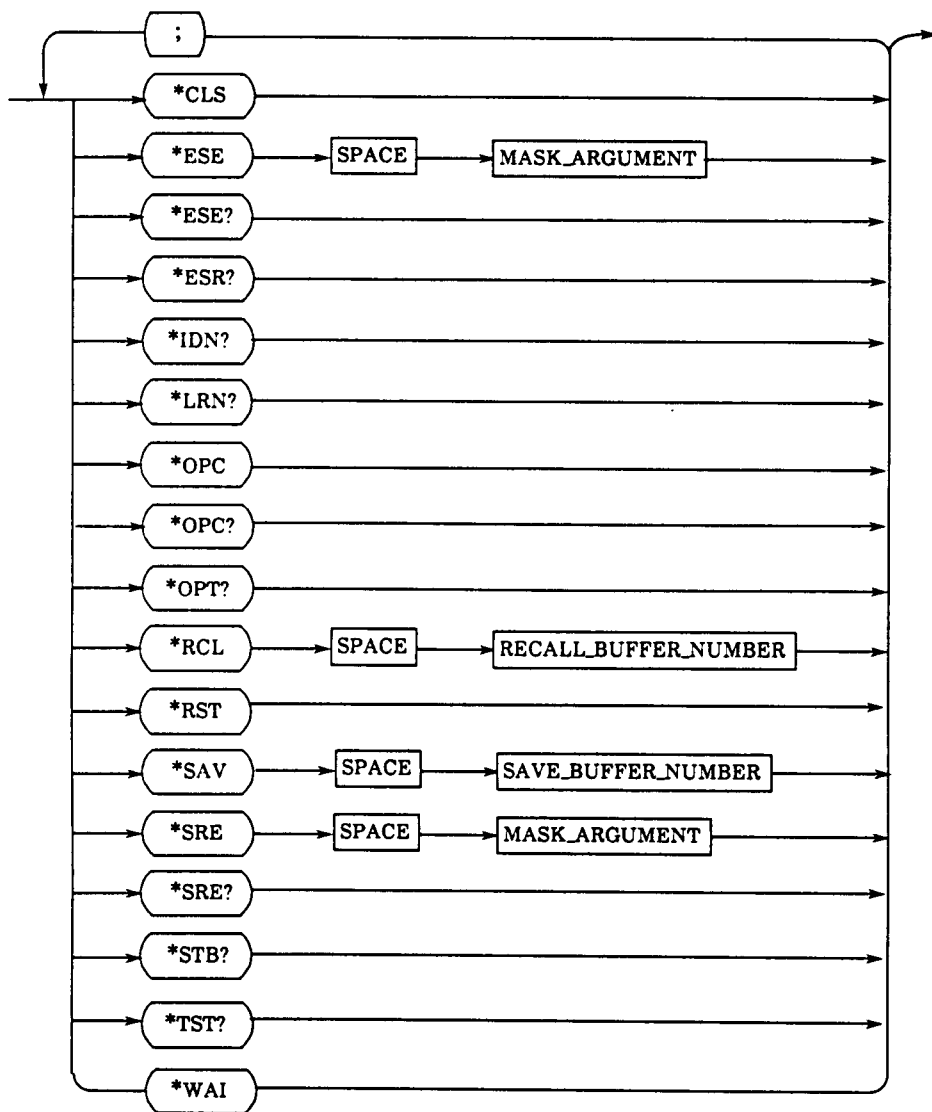

**(1)\*CLS (Clear Status) \_\_\_\_\_ Command**

The \*CLS command clears status data structures, including the event register generating each summary bit of status byte.

As a result, the summary bit corresponding to the status byte which is logical OR of these events is also cleared. However, the output queue is not affected by the \*CLS command.

Command syntax  
\*CLS

Example:  
PRINT #1,"CLS"

**(2) \*ESE (Event Status Enable)**\_\_\_\_\_ **command/query**

This command is permission request of the Standard Event Status Enable Register.

This command sets the mask pattern of the Standard Event Status Enable Register. The mask pattern is specified by a decimal number (integer) in the range of 0 to 255. (Refer to the weight column in Table 8-2.)

If a decimal number out of the range is specified, an execution error will occur.

Command syntax  
\*ESE < mask >

Query syntax  
\*ESE?

Returned format  
< mask >

Where: < mask > :: = 0~255

Example:  
PRINT #1,"\*ESE 32"

Example:  
PRINT #1,"\*ESE?"  
INPUT #1,ESES

This example shows that when an execution occurs, the service request is prepared for issue.

**Table 8-2 Standard Event Status Enable Register**

Bit	Weight	Enables
7	128	Power on
6	64	Not Used
5	32	Command Error
4	16	Not Used
3	8	Not Used
2	4	Not Used
1	2	NOGO Request
0	1	Operation Complete

For the status, refer to Fig. 8-2 Data structure of status report function.

**(3)\*ESR (Event Status Register)**\_\_\_\_\_ **query**

Check of Standard Event Status Register.

The \*ESR command reads the contents of the Standard Event Status Register.

Query syntax  
\*ESR?

Returned format  
< status >

Where: < status > :: = 0~ 255

Example  
PRINT #1,"\*ESR?"  
INPUT #1,ESR\$



**Table 8-3 Standard event status register**

Bit	Weight	Enables
7	128	Power on
6	64	Not Used
5	32	Command Error
4	16	Not Used
3	8	Not Used
2	4	Not Used
1	2	NOGO Request
0	1	Operation Complete

For the status, refer to Fig. 8-2 Data structure of status report function.

**(4)\*IDN (Identification Number)\_\_\_\_\_query**

Query about ID (manufacture, model number, etc.) of instrument.

Use the \*IDN command to detect which instrument the controller is connected to on GPIB when starting up the system.

Query syntax  
\*IDN?

Returned format  
HITACHI DENSHI LTD.,VC-7504,0,X.X

Example  
PRINT #1,"\*IDN?"  
LINE INPUT #1,IDN\$

**(5)\*LRN (Learn)\_\_\_\_\_query**

Query about setup information on instrument.

The \*LRN command performs the same function as the : SYSTEM:SETUP? query.

Query syntax  
\*LRN

Returned format  
< setup >

Where: < setup > :: = #80000 x x x x < binary data >

Example  
PRINT #1,"\*LRN?"  
INPUT #1,LRN\$

**(6)\*OPC (Operation Complete)\_\_\_\_\_command/query**

When the process under execution is completed, the \*OPC command places bit 0 in the Standard Event Status Register.

Command syntax  
\*OPC

Query syntax  
\*OPC?

Returned format  
1

Example  
PRINT #1,"\*OPC"

Example  
PRINT #1,":RUN;\*OPC?"  
INPUT#1,OPCS

### (7)\*OPT (Option)\_\_\_\_\_query

Query about connection information on options installed in the instrument. This command always returns "0".

Query syntax  
\*OPT?

Returned format  
0

Example  
PRINT #1,"\*OPT?"  
INPUT #1,OPTS

### (8)\*RCL (Recall)\_\_\_\_\_command

The \*RCL command reads setup information from the specified panel save area, and sets the instrument.

Command syntax  
\*RCL {1|2|3|4|5|6|7|8|9|10}

Example  
PRINT #1,"\*RCL 3"

### (9)\*RST (Reset)\_\_\_\_\_command

The \*RST command places the instrument in the state set by the factory.

Command syntax  
\*RST

Example  
PRINT #1,"\*RST"

### (10)\*SAV (Save)\_\_\_\_\_command

The \*SAV command stores the setting of the instrument in the specified panel save area. The setup information stored by the \*SAV command can be set again by the \*RCL command.

Command syntax  
\*SAV {1|2|3|4|5|6|7|8|9|10}

Example  
PRINT #1,"\*SAV 3"

**(11)\*SRE (Service Request Enable)**\_\_\_\_\_command/query

Permission request of Service Request Enable Register.

The \*SRE command sets the mask pattern for generating the mask summary status (MSS) bit in the Service Request Enable Register.

The mask pattern is specified by a decimal number (integer) in the range from 0 to 191 .

If a value out of the range is specified, an execution error will occur.

Command syntax  
\*SRE <mask >

Query syntax  
\*SRE?

Returned format  
<mask >

Where: <mask >:: = 0~191

Example  
PRINT #1,"\*SRE 32"

Example  
PRINT #1,"\*SRE?"  
INPUT#1,SRES

**Table 8-4 Service Request Enable Register**

Bit	Weight	Enables
7	128	Not Used
6	64	MSS (Master Summary Bit)
5	32	ESB (Event Status Bit)
4	16	Not Used
3	8	Not Used
2	4	Not Used
1	2	Not Used
0	1	Not Used

For the status, refer to Fig. 8-2 Data structure of status report function.

**(12)STB (Status Byte)**\_\_\_\_\_query

check of status byte

Query syntax  
\*STB?

Returned format  
<status >

Where: <status >:: = 0~255

Example  
PRINT #1,"\*STB?"  
INPUT #1,STBS

**Table 8-5 Status Byte Register**

Bit	Weight	Enables
7	128	Not Used
6	64	MSS (Master Summary Bit)
5	32	ESB (Event Status Bit)
4	16	Not Used
3	8	Not Used
2	4	Not Used
1	2	Not Used
0	1	Not Used

For the status, refer to Fig. 8-2 Data structure of status report function.

**(13)\*TST (Test)**\_\_\_\_\_query

Query about self test (self diagnosis) results

The \*TST command performs a self test on the instrument and returns the results.

A zero indicates the test passed and a non-zero value indicates the test failed.

Query syntax  
\*TST?

Returned format  
<result>

Where: <result>:: = 0~255

Example  
PRINT #1,"\*TST?"  
INPUT #1,TST\$

**(14) \*WAI (Wait)**\_\_\_\_\_command

The \*WAI command has no function in the instrument.

Command syntax  
\*WAI

Example  
PRINT #1,"\*WAI"

### 8.3.2 Root Level Commands

The root level commands control basic functions of the instrument.

The following root level commands can be used in the instrument.

command header	command	program data
	/query	
:AUTOCAL	c/q	"ON", "OFF"
:AUTOSCALE	c	-
:BLANK	c	"CHANNEL1", "CHANNEL2", "CHANNEL3"; "CHANNEL4"; "FUNCTION1", "FUNCTION2"
:CALIBRATE	q	-
:DIGITIZE	c	-
:ERASE	c	-
:MERGE	c	1~9999
:PLOT	q	-
:PRINT	c	-
:RUN	c	-
:STATUS	q	"CHANNEL1", "CHANNEL2", "CHANNEL3"; "CHANNEL4"; "FUNCTION1", "FUNCTION2"
:STOP	c	-
:VIEW	c	"CHANNEL1", "CHANNEL2", "CHANNEL3"; "CHANNEL4"; "FUNCTION1", "FUNCTION2"
:RECALL	c	1~9999

\*) Not provided for the VC-7502

The command syntax of the root level commands is shown below.

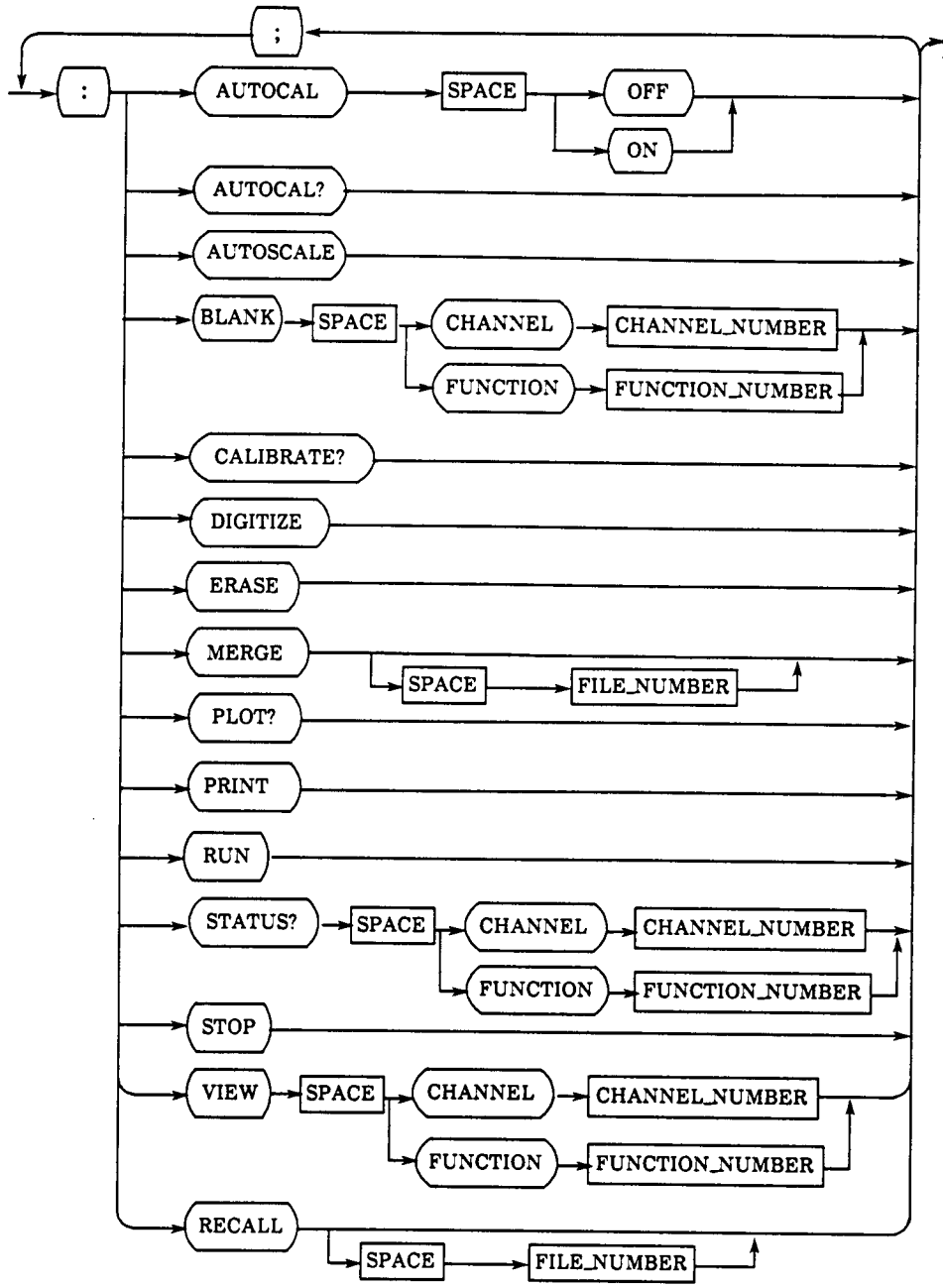

## (1)AUTOCAL \_\_\_\_\_command/query

Turning ON/OFF AUTO VPOS calibration

Command syntax  
:AUTOCAL {ON | OFF}

Query syntax  
:AUTOCAL?

Returned format  
{ON | OFF}

Example  
PRINT #1,":AUTOCAL ON"

Example  
PRINT #1,":AUTOCAL?"  
INPUT#1,AUTOCALS

The AUTO VPOS calibration is turned ON.

The present AUTO VPOS calibration status is entered.

## (2)AUTOSCALE \_\_\_\_\_command

Execution of AUTOSCALE.

Command syntax  
:AUTOSCALE

Example  
PRINT #1,":AUTOSCALE"

The AUTO SETUP is executed.

## (3)BLANK \_\_\_\_\_command

The BLANK command turns OFF the specified channel.(VC-7502 is not provided with CHANNEL 3|4 )

Command syntax  
:BLANK {CHANNEL{1 | 2 | 3 | 4} | FUNCTION{1 | 2}}

Example  
PRINT #1,":BLANK CHANNEL1"

Input to CH1 is turned off.

## (4)CALIBRATE \_\_\_\_\_query

Execution of FULL CALIBRATION.

Query syntax  
:CALIBRATE?

Returned format  
{PASS | FAIL}

Example  
PRINT #1,":CALIBRATE?"  
INPUT #1,CALIBS

The CALIBRATE command executes FULL CALIBRATION and returns the results.

## (5)DIGITIZE \_\_\_\_\_command

The DIGITIZE command performs acquisition once on the channels with input ON in the HOLD status. In the RUNNING status, the command holds the status

Command syntax  
:DIGITIZE

Example  
PRINT #1,":DIGITIZE"

## (6)ERASE \_\_\_\_\_command

The ERASE command erases waveform display.

This command performs the same function as that of pressing the WAVEFORM CLEAR key on the panel.

Command syntax  
:ERASE

Example  
PRINT #1,":ERASE"

## (7)MERGE \_\_\_\_\_command

The waveforms are saved to the specified file .

When <file\_no> is omitted, the same function as the WAVEFORM SAVE key on the panel is executed.

In case of the save to the internal pixel memory, the specified number is ignored.

Command syntax  
:MERGE <file-no>

Where:<file-no> := 1 ~ 9999

Example  
PRINT #1,":MERGE 10"

## (8)PLOT \_\_\_\_\_query

The PLOT command plots the CRT display.

Query syntax  
:PLOT?

Example  
PRINT #1,":PLOT?"  
WBYTE &H3F,&H5F,&H41,&H22

The address = 2 plotter is made to plot.

## (9)PRINT \_\_\_\_\_command

The PRINT command makes the built-in printer print the CRT display.

Command syntax  
:PRINT

Example  
PRINT #1,":PRINT"



## (10)RUN \_\_\_\_\_command

The RUN command places the instrument in the RUN state.

Command syntax  
:RUN

Example  
PRINT #1,":RUN"

The status is changed to the RUNNING status.

## (11)STATUS \_\_\_\_\_query

The STATUS command returns the information on whether the specified channel is on or off. To turn on a channel, use the VIEW command and to turn off a channel, use the BLANK command.(VC-7502 is not provided with CHANNEL 3 | 4 )

Query syntax  
:STATUS? {CHANNEL{1 | 2 | 3 | 4} | FUNCTION{1 | 2}}

Returned format  
{ON | OFF}

Example  
MPRINT #1,":STATUS? CHANNEL1"  
MINPUT #1,STATUS\$

The display setting on channel 1 is returned.

## (12)STOP \_\_\_\_\_command

The STOP command places the instrument in the HOLD state.

Command syntax  
:STOP

Example  
PRINT #1,":STOP"

The status is changed to the HOLD status.

## (13)VIEW \_\_\_\_\_command

The VIEW command turns on the specified channel.(VC-7502 is not provided with CHANNEL 3 | 4)

Command syntax  
:VIEW {CHANNEL{1 | 2 | 3 | 4} | FUNCTION{1 | 2}}

Example  
PRINT #1,":VIEW CHANNEL1"

Input to CH1 is turned on.

**(14)RECALL \_\_\_\_\_ command**

The waveform data are recalled from the specified file.

When <file-no> is omitted, the same function as the WAVEFORM RECALL key on the panel is executed.

Command syntax  
:RECALL <file-no>

Where: <file-no> := 1 ~ 9999

Example of programming  
PRINT #1, ":RECALL 10"

### 8.3.3 SYSTEM Commands

The SYSTEM subsystem commands change and return the setup state of the instrument and control the return of error information for each command.

The following SYSTEM subsystem commands can be used in the instrument.

command header	command /query	program data
:SYSTEM:ERROR	q	-
:SYSTEM:SETUP	c/q	-

The command syntax of the SYSTEM subsystem commands is shown below.

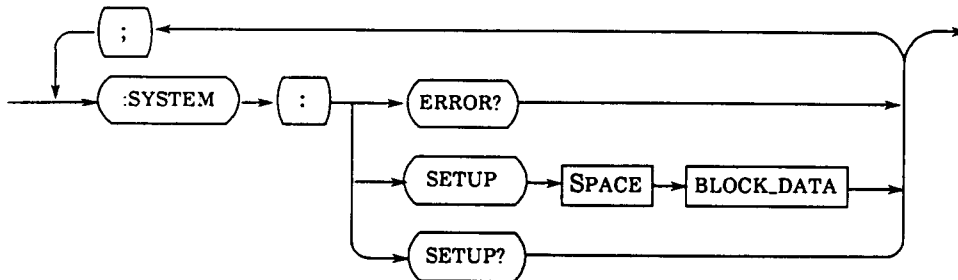

#### (1)ERROR \_\_\_\_\_query

The ERROR command returns error information during command execution.

Maximum 15 errors of error information are stored in the error queue.

Pieces of error information in the error queue are read out one by one by this command.

When the error queue is empty, "0" is returned.

Query syntax

:SYSTEM:ERROR?

Returned format:

< error >

Where: Error information of < error >:: = integer

Example

PRINT #1,":SYSTEM:ERROR?"

INPUT #1,ERRORS

The returned error codes are as follows:

	Error code
Normal end	0
Comand error	-100

Command syntax  
:SYSTEM:SETUP < setup >

Query syntax  
:SYSTEM:SETUP?

Returned format  
< setup >

Where: < setup > ::= #8000XXXX < binarydata >

«Quick Basic»

Example

DIM ISETUP\$(1500)	'Definition of array.
SCREEN 2	'Sets the screen mode.
CLS 0	'Clear screen
WINDOW(0, 0)-(2048, 356)	'Set the window
OPEN "COM1:9600,N,8,1,LF,RS"	
FOR RANDOM AS#1	'Open the RS-232C(COM1).
PRINT #1, ":SYSTEM:SETUP?;"	
DAT\$ = INPUT\$(1, #1)	'Reads "#".
PRINT DAT\$	'Print "#" to display.
STRLEN# = INPUT\$(1, #1)	'Read "8"
PRINT STRLEN\$	'Prints "8" to display.
STRLEN = VAL(STRLEN\$)	'Converts characters to figures.
FOR I = 1 TO STRLEN	'Starts to read block length.
BLEN\$ = INPUT\$(1, #1)	'Reads one character.
BLOCKLEN\$ = BLOCKLEN	
+ BLEN\$	'Adds acquire characters to
	'Character-string one by one.
NEXT	
PRINT BLOCKLEN#	'Print block length to display.
BLOCKLEN = VAL(LEFT\$(	
BLOCKLEN\$, STRLEN) )	'Converts characters to figures.
FOR I = 1 TO BLOCKLEN + 1	'Starts to read setup data.
ISETUP\$(I) =	
INPUT\$(1, #1)	'Reads one byte.
NEXT	
PRINT "Push any key"	'Prints message to display.
LOPJMP: A\$ = INKEY\$: IF A\$ =	
"" THEN GOTO LOPJMP	'Waits key input.
COMD\$ = ":SYSTEM:SETUP #"	
+ STRLEN\$ + BLOCKLEN\$	'The setup command is set to
	'setup header.
PRINT #1, COMD\$;	'Transfers the setup command
	'and header.
FOR I = TO BLOCKLEN-1	'Starts to transfer setup data.
PRINT #1, ISETUP\$(I);	'Transfers one byte.
PRINT ASC(ISETUP\$(I) );	'Converts setup data to
	'character code.
NEXT	
PRINT #1, ISETUP\$(I)	'Transfers delimiters.
PRINT ASC(ISETUP\$(I) )	'Prints delimiters to display.
CLOSE #1	'Close the RS-232C (COM1).
END	'End

### 8.3.4 ACQUIRE Commands

The ACQUIPE subsystem commands control the operation mode for entering data. The following ACQUIRE subsystem commands can be used in the instrument.

command header	command	program data
:ACQUIRE:COUNT	c/q	"OFF", "2", "4", "8", "16", "32", "64", "128", "256"
:ACQUIRE:POINTS	q	- (In case of VC-7504/VC-7502)
:ACQUIRE:POINTS	c/q	"512", "1024", "10240", "51200", "102400", "512000", "1024000", "2048000" (In case of VC-7524)
:ACQUIRE:TYPE	c/q	"NORMAL", "HIGH_DENSITY", "ENVELOPE", "PILE", "LONG" (VC-7524 only), "SPLIT" (VC-7524 only), "PEEK_DETECT", (VC-7502/04)
:ACQUIRE:SEGMENT	c/q	2~2000(VC-7524 only)
:ACQUIRE:ENVELOPE	c/q	"2", "4", "8", "16", "32", "64", "128", "256", "512", "1024", "2048", "INFINITE"

The command syntax of the ACQUIRE subsystem command is shown below.

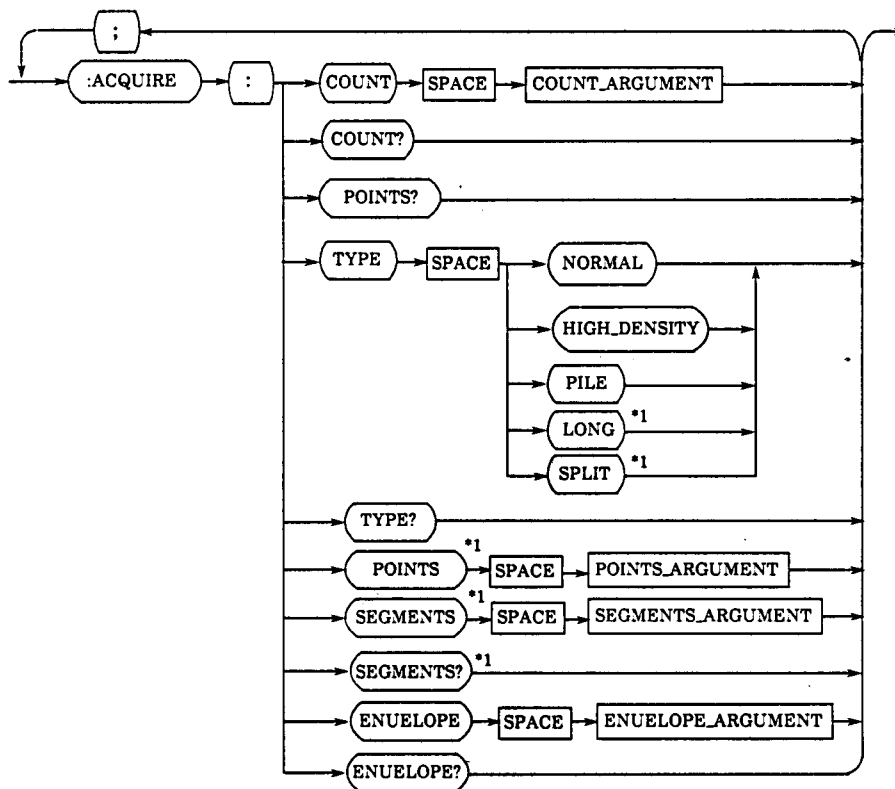

\*1) VC-7524 only

## (1)COUNT \_\_\_\_\_command/query

The COUNT command executes average and changes the times.

Command syntax

:ACQUIRE:COUNT {OFF | 2 | 4 | 8 | 16 | 32 | 64 | 128 | 256}

Query syntax

:ACQUIRE:COUNT?

Returned format

{OFF | 2 | 4 | 8 | 16 | 32 | 64 | 128 | 256}

Example

PRINT #1,":ACQUIRE:COUNT 64"

Example

PRINT #1,":ACQUIRE:COUNT?"

INPUT #1,COUNTS

Average is turned on and the average times are set to 64.

The present average times are returned.

## (2)POINTS \_\_\_\_\_query

The POINTS command returns the number of data to be entered by one sampling.

Further, when "ACQUIRE:TYPE" is set to LONG or SPLIT on the VC-7524, the number of data entered at one sampling can be set.

Query syntax

:ACQUIRE:POINTS?

Query syntax (VC-7524 only)

:ACQUIRE:POINTS<points argument2>

Returned format

<points argument1 >

Where,

VC-7504/VC-7502

<points\_argument1 >: : = 0~8192

VC-7524

<points\_argument1 >: : = 0~2048000

<points\_argument2 >: : = {512 | 1024 | 10240 | 51200 |

102400 | 512000 | 1024000 | 2048000}

Example

PRINT #1,":ACQUIRE:POINTS?"

INPUT #1,POINTSS

The present number of data to be entered is returned.

## (3)TYPE \_\_\_\_\_command/query

The TYPE command establishes the acquisition mode.

Command syntax

:ACQUIRE:TYPE {NORMAL | HIGH-DENSITY |  
PILE | LONG (VC-7524 only) | SPLIT  
(VC-7524 only) | ENVELOPE | PEEK-  
DETECT(VC-7502/04)}

Query syntax

:ACQUIRE:TYPE?

Returned format

{NORMAL | HIGH-DENSITY |  
PILE | LONG (VC-7524 only) | SPLIT  
(VC-7524 only) | ENVELOPE | PEEK-  
DETECT(VC-7502/04)}

Example

PRINT #1,":ACQUIRE:TYPE NORMAL"

Example

PRINT #1,":ACQUIRE:TYPE?"

INPUT #1,TYPE\$

**(4)SEGMENTS(VC-7524 only)**\_\_\_\_\_ **command/query**

Set the number of the maximum sampling segments in the memory split mode.

Command syntax  
:ACQUIRE:SEGMENTS < segments argument >

Query syntax  
:ACQUIRE:SEGMENTS?

Returned format  
< segments argument >

Where: < segments argument > :: = 2~2000

**(5)ENVELOPE**\_\_\_\_\_ **command/query**

Changes the number of time of envelope.

Command syntax  
:ACQUIRE:ENVELOPE{2 | 4 | 8 | 16 | 32 | 64 | 128 |  
256 | 512 | 1024 | 2048 | INFINITE}

Query syntax  
:ACQUIRE:ENVELOPE?

Returned format  
{2 | 4 | 8 | 16 | 32 | 64 | 128 | 256 | 512 |  
1024 | 2048 | INFINITE}

Example of programming  
PRINT #1,":ACQUIRE:ENVELOPE 64"

Example of programming  
PRINT #1,":ACQUIRE:ENVELOPE?"  
INPUT #1,ENVELOPE\$

The number of time of envelope is set to 64.

The current number of time of envelope is returned.

### 8.3.5 CHANNEL Commands

The CHANNEL subsystem commands control the functions related to the vertical axis of the instrument.

The following CHANNEL subsystem commands can be used in the instrument.

command header	command	program data
:CHANNEL <N>:COUPLING	c/q	"AC", "DC", "GND"
:CHANNEL <N>:OFFSET	c/q	Volts...exponential(NR3)
:CHANNEL <N>:PROBE	c/q	"X1", "X10", "X100"
:CHANNEL <N>:RANGE	c/q	Volts...exponential(NR3)

The command syntax of the CHANNEL subsystem commands is shown below.

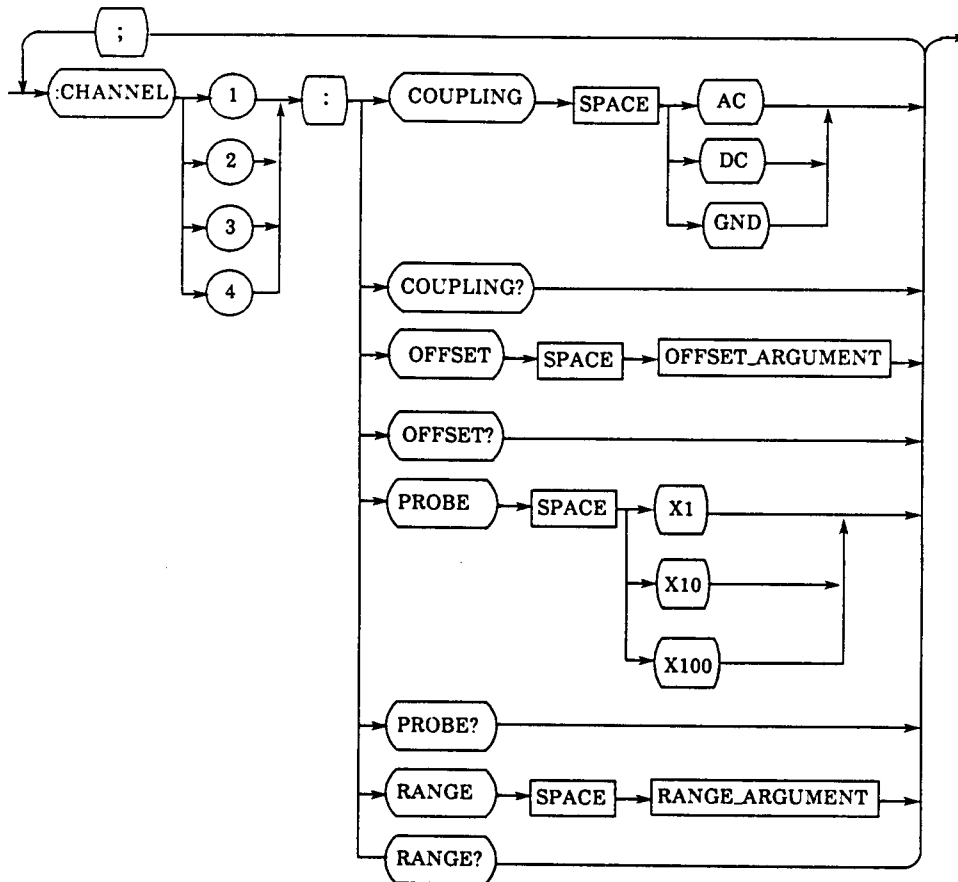



## (1) COUPLING \_\_\_\_\_ command/query

The COUPLING command switches the coupling on the input channel to any one of AC/DC/GND.  
(VC-7502 is not provided with CHANNEL 3 | 4 )

Command syntax  
:CHANNEL{1 | 2 | 3 | 4}:COUPLING {AC | DC | GND}

Query syntax  
:CHANNEL{1 | 2 | 3 | 4}:COUPLING?

Returned format  
{AC | DC | GND}

Example  
PRINT #1,":CHANNEL2:COUPLING AC"

Example  
PRINT #1,":CHANNEL3:COUPLING?"  
INPUT #1,COUPLINGS

The coupling on CH2 is switched to AC.

The coupling information on CH3 is returned.

## (2) OFFSET \_\_\_\_\_ command/query

The OFFSET command changes the V position of a waveform by switching the offset voltage.  
The value of the offset voltage is converse to the sign of the V position displayed on the CRT screen.(VC-7502 is not provided with CHANNEL 3 | 4 )

Command syntax  
:CHANNEL{1 | 2 | 3 | 4}:OFFSET < offset-data >

Query syntax  
:CHANNEL{1 | 2 | 3 | 4}:OFFSET?

Returned format  
< offset-data >

Where, < offset data > :: = offset voltage (NR3)

Example  
PRINT #1,":CHANNEL2:OFFSET 1"

Example  
PRINT #1,":CHANNEL3:OFFSET?"  
INPUT #1,OFFSETS

The offset voltage on CH1 is switched to 1 volt.

The offset voltage value on CH3 is received and displayed.

## (3) PROBE \_\_\_\_\_ command/query

The PROBE command switches the probe factor value for the input channel.  
(VC-7502 is not provided with CHANNEL 3 | 4)

Command syntax  
:CHANNEL{1 | 2 | 3 | 4}:PROBE {X1 | X10 | X100}

Query syntax  
:CHANNEL{1 | 2 | 3 | 4}:PROBE?

Returned format  
{X1 | X10 | X100}

Example  
PRINT #1,":CHANNEL2:PROBE X1"

Example  
PRINT #1,":CHANNEL3:PROBE?"  
INPUT #1,PROBES

The probe factor value on CH2 is switched to X1.

The probe factor value on CH3 is returned.

## (4) RANGE \_\_\_\_\_ command/query

The RANGE command sets the full-scale input sensitivity for the specified channel.  
(VC-7502 is not provided with CHANNEL 3 | 4 )

### Command syntax

:CHANNEL{1 | 2 | 3 | 4}:RANGE <range data >

### Query syntax

:CHANNEL{1 | 2 | 3 | 4}:RANGE?

### Returned format

<range data >

Where, <range data >::= Voltage value of full scale (NR3)

### Example

PRINT #1,":CHANNEL2:RANGE 8"

### Example

PRINT #1,":CHANNEL3:RANGE?"  
INPUT#1,RANGES

The sensitivity on CH2 is switched to 1 VOLT/DIV.

The present sensitivity on CH3 received and displayed.

### 8.3.6 DISPLAY Commands

The DISPLAY subsystem commands control the functions related to display.  
The following DISPLAY subsystem commands can be used in the instrument.

command header	command	program data
	/query	
:DISPLAY:GRID	c/q	"GRID", "FRAME", "AXES"
:DISPLAY:PERSISTENCE	c/q	"REFRESH", "INFINITE"
:DISPLAY:DOTJOIN	c/q	"ON", "OFF"
:DISPLAY:INTERPOLATE	c/q	"LINEAR", "SINE", "OFF"
:DISPLAY:HORIZONTAL	c/q	"A", "ALT", "B"
:DISPLAY:ZOOM	c/q	"SINGLE", "DUAL"
:DISPLAY:SCROLL < N >	c/q	Seconds ..... exponential(NR3)
:DISPLAY:SEGMENT < N >	c/q	2~2000(VC-7524 only)
:DISPLAY:CLEAR	c/q	"CURRENT", "RECALL", "ALL"

The command syntax of the DISPLAY subsystem commands is shown below.

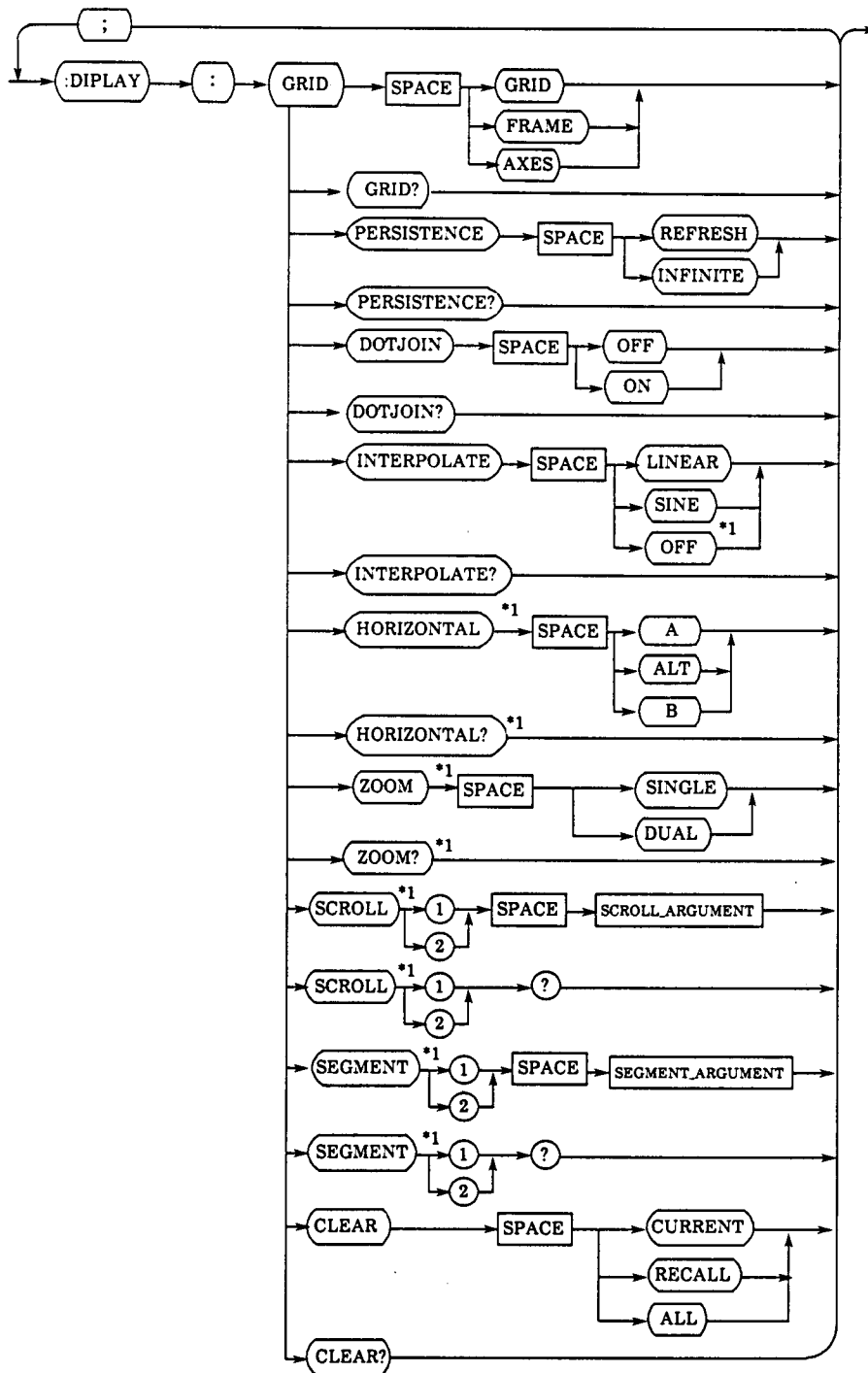

\*1 VC-7524 only

## (1)GRID \_\_\_\_\_command/query

The GRID command switches the scale to any one of GRID/AXES/FRAME.

Command syntax  
:DISPLAY:GRID {GRID | FRAME | AXES}

Query syntax  
:DISPLAY:GRID?

Returned format  
{GRID | FRAME | AXES}

Example  
PRINT #1,":DISPLAY:GRID AXES"

Example  
PRINT #1,":DISPLAY:GRID?"  
INPUT#1,GRID\$

The scale is set to GRID.

The present scale setting is returned.

## (2)PERSISTENCE \_\_\_\_\_command/query

The PERSISTENCE command switches the setting of overwrite.

Command syntax  
:DISPLAY:PERSISTENCE {REFRESH | INFINITE}

Query syntax  
:DISPLAY:PERSISTENCE?

Returned format  
{REFRESH | INFINITE}

Example  
PRINT #1,":DISPLAY:PERSISTENCE INFINITE"

Example  
PRINT #1,":DISPLAY:PERSISTENCE?"  
INPUT#1,PERSISTENCES

Overwrite is set to INFINITE.

The present overwrite setting is returned.

## (3)DOTJOIN \_\_\_\_\_command/query

The DOTJOIN command turns on or off the dotjoin.

Command syntax  
:DISPLAY:DOTJOIN {ON | OFF}

Query syntax  
:DISPLY:DOTJOIN?

Returned format  
{ON | OFF}

Example  
PRINT #1,":DISPLAY:DOTJOIN ON"

Example  
RPINT #1,":DISPLAY:DOTJOIN?"  
INPUT#1,DOTJOINS

The dotjoin is set to ON.

The present dotjoin setting is returned.

#### (4)INTERPOLATE \_\_\_\_\_ command/query

The INTERPOLATE command switches the setting of interpolation.

Command syntax  
:DISPLAY:INTERPOLATE {LINEAR | SINE | OFF}

Query syntax  
:DISPLY:INTERPOLATE?

Returned format  
{LINEAR | SINE | OFF}

Example  
PRINT #1,":DISPLAY:INTERPOLATE SINE"

Example  
PRINT #1,":DISPLAY:INTERPOLATE?"  
INPUT#1,INTERPOL\$

SIN interpolation is turned on.

The present interpolation setting is returned.

#### (5)HORIZONTAL \_\_\_\_\_ Command/query

Switch the display of the horizontal axis to A/ALT/B.

Command syntax  
:DISPLAY:HORIZONTAL {A | ALT | B}

Query systax  
:DISPLAY:HORIZONTAL?

Returned format  
{A | ALT | B}

#### (6)ZOOM \_\_\_\_\_ Command/query

Switch the display of the magnified waveform to SINGLE/DUAL.

Command syntax  
:DISPLAY:ZOOM {SINGLE | DUAL}

Query systax  
:DISPLAY:ZOOM?

Returned format  
{SINGLE | DUAL}

#### (7)SCROLL < N > \_\_\_\_\_ Command/query

Set the display position of the magnified waveform.

Command syntax  
:DISPLAY:SCROLL {1 | 2} < scroll >

Query systax  
:DISPLY:SCROLL {1 | 2} ?

Returned format  
< scroll >

Where: < scroll > :: = Delay time (s) (NR3)

#### (8)SEGMENT < N > (VC-7524 only) \_\_\_\_\_ Command/query

Set the segments of the waveform displayed in the memory split mode.

Command syntax  
:DISPLAY:SEGMENT {1 | 2} < segment >

Query systax  
:DISPLY:SEGMENT {1 | 2} ?

Returned format  
< segment >

Where: < segment > :: = 2~2000

## (9)CLEAR

## Command/query

The CLEAR command selects the waveform to be cleared.

### Command syntax

:DISPLAY:CLEAR {CURRENT | RECALL | ALL}

### Query syntax

:DISPLAY:CLEAR?

### Returned format

{CURRENT | RECALL | ALL}

### Example

PRINT #1,":DISPLAY:  
CLEAR ALL"

All waveform is select

### Example

PRINT #1,":DISPLAY:  
CLEAR? "  
LINE INPUT#1,CLEAR\$

The present setting is returned.

### 8.3.7 MEASURE Commands

The MEASURE subsystem commands control the measuring function of the instrument. Each executing a MEASURE command makes the instrument perform measurements.

The following MEASURE subsystem commands can be used in the instrument.

command header	command	program data
	/query	
:MEASURE:ALL	q	-
:MEASURE:DUTYCYCLE	q	-
:MEASURE:FALLTIME	q	-
:MEASURE:FREQUENCY	q	-
:MEASURE:MODE	c/q	"OFF", "VCURSOR", "TCURSOR", "CROSSCURSOR", "PULSE-PARAMETER"
:MEASURE:NWIDTH	q	-
:MEASURE:OVERSHOOT	q	-
:MEASURE:PERIOD	q	-
:MEASURE:PRESHOOT	q	-
:MEASURE:PWIDITH	q	-
:MEASURE:RISETIME	q	-
:MEASURE:SOURCE	c/q	"CHANNEL1", "CHANNEL2", "MEMORY1", "MEMORY2", "CHANNEL3"* , "CHANNEL4"*, "MEMORY3", MEMORY4"
:MEASURE:TSTART	c/q	-256 ~ 256
:MEASURE:TSTOP	c/q	-256 ~ 256
:MEASURE:TDELTA	q	Volts...exponential(NR3)
:MEASURE:VAMPLITUDE	q	-
:MEASURE:VAVERAGE	q	-
:MEASURE:VBASE	q	-
:MEASURE:VMAX	q	-
:MEASURE:VMIN	q	-
:MEASURE:VPP	q	-
:MEASURE:VRMS	q	-
:MEASURE:VSTART	c/q	-127 ~ 127
:MEASURE:VSTOP	c/q	-127 ~ 127
:MEASURE:VDELTA	q	Volts...exponential(NR3)
:MEASURE:VTOP	q	-
:MEASURE:PSTART	c/q	-256 ~ 256
:MEASURE:PSTOP	c/q	-256 ~ 256

\*) Not provided for the VC-7502



The command syntax of the MEASURE subsystem commands is shown below.

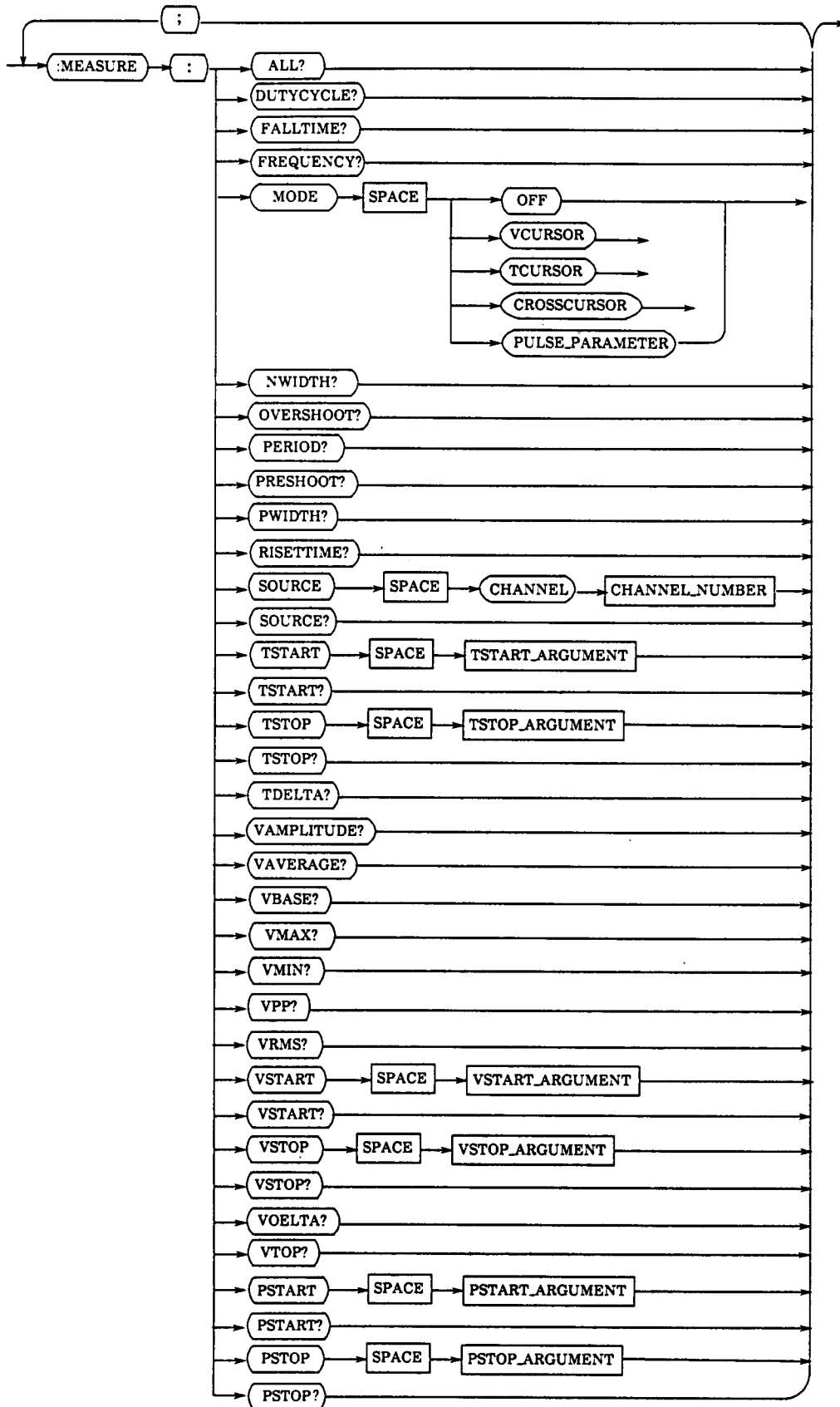

## (1) ALL \_\_\_\_\_ query

The ALL command returns all the pulse parameter measured values.

Query syntax  
:MEASURE:ALL?

Returned format  
< DUTY CYCLE result >, < FALL TIME result >, < FREQUENCY result >, < NWIDTH result >, < OVERSHOOT result >, < PERIOD result >, < PRESHOOT result >, < PWIDTH result >, < RISETIME result >, < VAMPLITUDE result >, < VAVERAGE result >, < VBASE result >, < VMAX result >, < VMIN result >, < VPP result >, < VRMS result >, < VTOP result >

Where, < result > :: = each measurement result (NR3)

Example  
PRINT #1,":MEASURE:ALL?"  
LINE INPUT #1,ALL\$

The present number of data to be entered is returned.

## (2) DUTYCYCLE \_\_\_\_\_ query

The DUTYCYCLE command returns the duty cycle measured value.

Query syntax  
:MEASURE:DUTYCYCLE?

Returned format  
< value >

Where, < value > :: = Duty cycle measured value (%) (NR3)

Example  
PRINT #1,":MEASURE:DUTYCYCLE?"  
INPUT #1,VALUES\$

## (3) FALLTIME \_\_\_\_\_ query

The FALLTIME command returns the falltime measured value.

Query syntax  
:MEASURE:FALLTIME?

Returned format  
< value >

Where, < value > :: = Falltime measured value (second) (NR3)

Example  
PRINT #1,":MEASURE:FALLTIME?"  
INPUT #1,VALUES\$

#### (4) FREQUENCY \_\_\_\_\_ query

The FREQUENCY command returns the frequency measured value.

Query syntax  
:MEASURE:FREQUENCY?

Returned format  
< value >

Where, < value > :: = Frequency measured value (Hz) (NR3)

Example  
PRINT #1,":MEASURE:FALLTIME?"  
INPUT #1,VALUES

#### (5) MODE \_\_\_\_\_ command/query

The MODE command selects the measuring function from OFF/V cursor/T cursor/ + cursor/pulse parameter.

Command syntax  
:MEASURE:MODE {OFF | VCURSOR | TCURSOR |  
CROSSCURSOR | PULSE-PARAMETER}

Query syntax  
:MEASURE:MODE?

Returned format  
{OFF | VCURSOR | TCURSOR |  
CROSSCURSOR | PULSE-PARAMETER}

Example  
PRINT #1,":MEASURE:MODE TCURSOR"

The measuring function is set to TCOURSOR.

Example  
PRINT #1,":MEASURE:MODE?"  
INPUT #1,MODE\$

The measuring function presently selected is returned.

#### (6) NWIDTH \_\_\_\_\_ query

The negative pulse width measured value is returned.

Query syntax  
:MEASURE:NWIDTH?

Returned format  
< value >

Where, < value > :: = Negative pulse width measured value(second) (NR3)

Example  
PRINT #1,":MEASURE:NWIDTH?"  
INPUT #1,VALUES

## **(7)OVERSHOOT** \_\_\_\_\_query

The OVERSHOOT command returns the overshoot measured value.

Query syntax  
:MEASURE:OVERSHOOT?

Returned format  
< value >

Where, < value > :: = Overshoot measured value (Volt) (NR3)

Example  
PRINT #1,":MEASURE:OVERSHOOT?"  
INPUT #1,VALUES

## **(8)PERIOD** \_\_\_\_\_query

The PERIOD command returns the period measured value.

Query syntax  
:MEASURE:PERIOD?

Returned format  
< value >

Where, < value > :: = Period measured value (second) (NR3)

Example  
PRINT #1,":MEASURE:PERIOD?"  
INPUT #1,VALUES

## **(9)PRESHOOT** \_\_\_\_\_query

The PRESHOOT command returns the preshoot measured value.

Query syntax  
:MEASURE:PRESHOOT?

Returned format  
< value >

Where, < value > :: = Preshoot measured value (Volt) (NR3)

Example  
PRINT #1,":MEASURE:PRESHOOT?"  
INPUT #1,VALUES

## **(10)PWIDTH** \_\_\_\_\_query

The PWIDTH command returns the positive pulse width measured value.

Query syntax  
:MEASURE:PWIDTH?

Returned format  
< value >

Where, < value > :: = Position pulse width measured value (second) (NR3)

Example  
PRINT #1,":MEASURE:PWIDTH?"  
INPUT #1,VALUES

## (11)RISETIME \_\_\_\_\_ query

The RISETIME command returns the risetime measured value.

Query syntax  
:MEASURE:RISETIME?

Returned format  
< value >

Where, < value > :: = Rise time measured value (second) (NR3)

Example  
PRINT #1,":MEASURE:RISETIME?"  
INPUT #1,VALUES

## (12)SOURCE \_\_\_\_\_ command/query

The SOURCE command sets the channel to be measured.(VC-7502 is not provided with CHANNEL 3 | 4 )

Command syntax  
:MEASURE:SOURCE {CHANNEL{1 | 2 | 3 | 4 } |  
MEMORY {1 | 2 | 3 | 4 } }

Query syntax  
:MEASURE:SOURCE?

Returned format  
{ CHANNEL{1 | 2 | 3 | 4 } |  
MEMORY {1 | 2 | 3 | 4 } }

Example  
PRINT #1,":MEASURE:SOURCE CHANNEL4"

Example  
PRINT #1,":MEASURE:SOURCE?"  
INPUT #1,SOURCES

The channel to be measured is set to CH4.

The present channel to be measured is returned.

## (13)TSTART \_\_\_\_\_ command/query

The TSTART command sets the T reference cursor position.

Command syntax  
:MEASURE:TSTART < position >

Query syntax  
:MEASURE:TSTART?

Returned format  
< position >

Where, < position > :: = -256~256

Example  
PRINT #1,":MEASURE:TSTART 50"

Example  
PRINT #1,":MEASURE:TSTART?"  
INPUT #1,TSTART\$

The T reference cursor position is set to 50. The present T reference cursor position is returned.

## (14)TSTOP \_\_\_\_\_command/query

The TSTOP command sets the T delta cursor position.

Command syntax  
:MEASURE:TSTOP <position >

Query syntax  
:MEASURE:TSTOP?

Returned format  
<position >

Where, <position > :: = -256~256

Example  
PRINT #1,":MEASURE:TSTOP 100"

Example  
PRINT #1,":MEASURE:TSTOP?"  
INPUT #1,TSTOP\$

The T delta cursor position is set to 100.  
The present T delta cursor position is returned.

## (15)TDELTA \_\_\_\_\_query

The TDELTA command returns the measured value of time difference.

Query syntax  
:MEASURE:TDELTA?

Returned format  
<value >

Where, <value > :: = Measured value of voltage difference (Volt) (NR3)

Example  
PRINT #1,":MEASURE:TDELTA?"  
INPUT #1,TDELTA\$

The measured value of time difference between two present T cursors is returned.

## (16)VAMPLITUDE \_\_\_\_\_query

The VAMPLITUDE command returns the measured value of voltage difference between the base voltage and the top voltage.

Query syntax  
:MEASURE:VAMPLITUDE?

Returned format  
<value >

Where, <value > :: = Measured value of voltage difference between the base voltage and the top voltage (Volt) (NR3)

Example  
PRINT #1,":MEASURE:VAMPLITUDE?"  
INPUT #1,VALUE\$

## (17)VAVERAGE \_\_\_\_\_query

The VAVERAGE command returns the average voltage measured value.

Query syntax  
:MEASURE:VAVERAGE?

Returned format  
< value >

Where, < value > :: = Average voltage measured value (Volt) (NR3)

Example  
PRINT #1,":MEASURE:VAVERAGE?"  
INPUT #1,VALUES

## (18)VBASE \_\_\_\_\_query

The VBASE command returns the base voltage measured value.

Query syntax  
:MEASURE:VBASE?

Returned format  
< value >

Where, < value > :: = Base voltage measured value (Volt) (NR3)

Example  
PRINT #1,":MEASURE:VBASE?"  
INPUT #1,VALUES

## (19)VMAX \_\_\_\_\_query

The VMAX command returns the maximum voltage measured value.

Query syntax  
:MEASURE:VMAX?

Returned format  
< value >

Where, < value > :: = Maximum voltage measured value (Volt) (NR3)

Example  
PRINT #1,":MEASURE:VMAX?"  
INPUT #1,VALUES

## (20)VMIN \_\_\_\_\_query

The VMIN command returns the minimum voltage measured value.

Query syntax  
:MEASURE:VMIN?

Returned format  
< value >

Where, < value > :: = Minimum voltage measured value (Volt) (NR3)

Example  
PRINT #1,":MEASURE:VMIN?"  
INPUT #1,VALUES

## (21)VPP \_\_\_\_\_ query

The VPP command returns the measured value of voltage difference between the maximum voltage and the minimum voltage.

Query syntax  
:MEASURE:VPP?

Returned format  
< value >

Where, < value > :: = Measured value of voltage difference between maximum voltage and minimum voltage. (Volt) (NR3)

Example  
PRINT #1,":MEASURE:VPP?"  
INPUT #1,VALUES

## (22)VRMS \_\_\_\_\_ query

The VRMS command returns the effective voltage measured value.

Query syntax  
:MEASURE:VRMS?

Returned format  
< value >

Where, < value > :: = Effective voltage measured value (Volt) (NR3)

Example  
PRINT #1,":MEASURE:VRMS?"  
INPUT #1,VALUES

## (23)VSTART \_\_\_\_\_ command/query

The VSTART command sets the V reference cursor position.

Command syntax  
:MEASURE:VSTART < position >

Query syntax  
:MEASURE:VSTART?

Returned format  
< position >

Where, < position > :: = -127~127

Example  
PRINT #1,":MEASURE:VSTART 50"

Example  
PRINT #1,":MEASURE:VSTART?"  
INPUT #1,VSTART\$



The V reference cursor position is set to 50. The present V reference cursor position is returned.

## (24)VSTOP \_\_\_\_\_command/query

The VSTOP command sets the V data cursor position.

Command syntax  
:MEASURE:VSTOP < position >

Query syntax  
:MEASURE:VSTOP?

Returned format  
< position >

Where, < position > :: = -127~127

Example  
PRINT #1,":MEASURE:TSTOP 100"

Example  
PRINT #1,":MEASURE:VSTOP?"  
INPUT #1,VSTOP\$

The data cursor position is set to 100. The present T data cursor position is returned.

## (25)VDELTA \_\_\_\_\_query

The VDELTA command returns the measured value of voltage difference between two V cursors.

Query syntax  
:MEASURE:VDELTA?

Returned format  
< value >

Where, < value > :: = Measured value of voltage difference (Volt) (NR3)

Example  
PRINT #1,":MEASURE:VDELTA?"  
INPUT #1,VDELTA\$

The measured value of voltage difference between two V cursors is returned.

## (26)VTOP \_\_\_\_\_query

The VTOP command returns the top voltage measured value.

Query syntax  
:MEASURE:VTOP?

Returned format  
< value >

Where, < value > :: = Top voltage measured value (Volt) (NR3)

Example  
PRINT #1,":MEASURE:VTOP?"  
INPUT #1,VALUES\$

**(27)PSTART** \_\_\_\_\_ **command/query**

The PSTART command sets the start cursor position.

Command syntax  
:MEASURE:PSTART < position >

Query syntax  
:MEASURE:PSTART?

Returned format  
< position >

Where, < position > :: = -256~256

Example  
PRINT #1,":MEASURE:PSTART 50"

Example  
PRINT #1,":MEASURE:PSTART?"  
LINE INPUT #1,PSTART\$

The start cursor position is set to 50. The present start cursor position is returned.

**(28)PSTOP** \_\_\_\_\_ **command/query**

The PSTOP command sets the stop cursor position.

Command syntax  
:MEASURE:PSTOP < position >

Query syntax  
:MEASURE:PSTOP?

Returned format  
< position >

Where, < position > :: = -256~256

Example  
PRINT #1,":MEASURE:PSTOP 100"

Example  
PRINT #1,":MEASURE:PSTOP?"  
LINE INPUT #1,PSTOP\$

The stop cursor position is set to 100. The present stop cursor position is returned.

### 8.3.8 TIMEBASE Commands.

The TIMEBASE subsystem commands control the functions related to the horizontal axis of the instrument.

The following TIMEBASE subsystem commands can be used in the instrument.

command header	command	program data
	/query	
:TIMEBASE:DELAY	c/q	Seconds...exponential(NR3)
:TIMEBASE:RANGE	c/q	Seconds...exponential(NR3)
:TIMEBASE:BRANGE	c/q	Seconds...exponential(NR3)

The command syntax of the TIMEBASE subsystem commands is shown below.

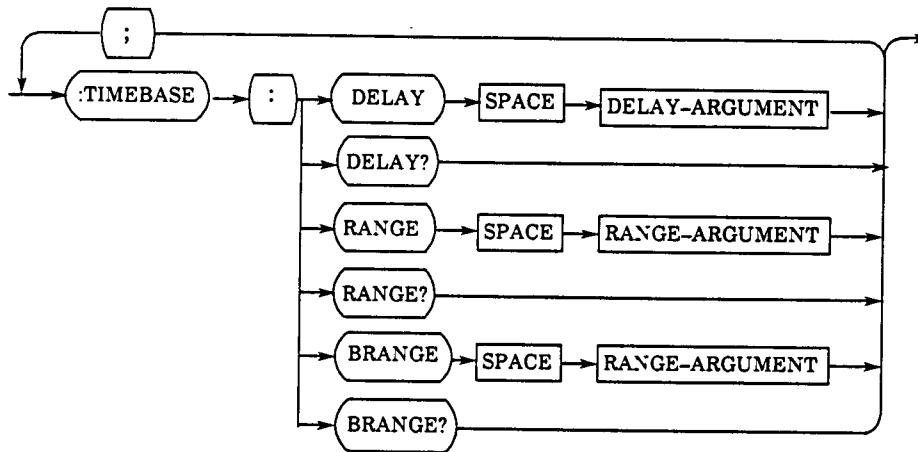

#### (1) DELAY \_\_\_\_\_ command/query

The DELAY command switches the delay time.

Command syntax  
:TIMEBASE:DELAY <delay >

Query syntax  
:TIMEBASE:DELAY?

Returned format  
<delay >

Where, <delay > ::= Delay time (second) (NR3)

Example  
PRINT #1,":TIMEBASE:DELAY 1E-3"

Example  
PRINT #1,":TIMEBASE:DELAY?"  
INPUT #1,DELAYS

The delay time is switched to 1ms.

The present delay time is received and displayed.

## (2)RANGE \_\_\_\_\_command/query

The RANGE command switches the full scale time set value.

Command syntax  
:TIMEBASE:RANGE <range>

Query syntax  
:TIMEBASE:RANGE?

Returned format  
<range>

Where, <range>:: = Full scale time set value <second) (NR3)

Example  
PRINT #1,":TIMEBASE:RANGE 100E-3"

Example  
PRINT #1,":TIMEBASE:RANGE?"  
INPUT #1,RANGES

The time range is switched to 100ms/div.

The present time range value is received and displayed.

## (3)BRANGE \_\_\_\_\_command/query

The BRANGE command switches the full scale time set value.

Command syntax  
:TIMEBASE:BRANGE <range>

Query syntax  
:TIMEBASE:BRANGE?

Returned format  
<range>

Where, <range>:: = Full scale time set value <second) (NR3)

Example  
PRINT #1,":TIMEBASE:BRANGE 100E-3"

Example  
PRINT #1,":TIMEBASE:BRANGE?"  
INPUT #1,RANGES

The time range is switched to 100ms/div.

The present time range value is received and displayed.

### 8.3.9 TRIGGER Commands

The TRIGGER subsystem commands control the trigger function of the instrument.

command header	command	program data
	/query	
:TRIGGER:ACTION	c/q	"IN", "OUT"
:TRIGGER:AUTO	c/q	"ON", "OFF"
:TRIGGER:COUPLING <N>	c/q	"DC", "AC", "LFREJ", "HFREJ"
:TRIGGER:DELAY	c/q	Seconds...exponential(NR3)
:TRIGGER:EVENTS	c/q	2~ 4097
:TRIGGER:FIELD <N>	c/q	"1", "2"
:TRIGGER:LEVEL <N>	c/q	Volts...exponential(NR3)
:TRIGGER:LINE <N>	c/q	1~625
:TRIGGER:MODE	c/q	"EDGE","WINDOW"," DELAY","EVENT", "TV H","TV V", "TVLINE"
:TRIGGER:POLARITY <N>	c/q	"POSITIVE", "NEGATIVE"
:TRIGGER:PRESET	c/q	"TTL", "ECL", "USER"
:TRIGGER:SELECT	c/q	"FIRST", "SECOND"
:TRIGGER:SLOPE <N>	c/q	"POSITIVE", "NEGATIVE"
:TRIGGER:SOURCE <N>	c/q	"CHANNEL1", "CHANNEL2", "CHANNEL3"*1, "CHANNEL4"*1, "EXT"*2, "EXT/10"*2
:TRIGGER:STANDARD	c/q	"525", "625"
:TRIGGER:UPPERLEVEL	c/q	Volts ... exponential (NR3)
:TRIGGER:LOWERLEVEL	c/q	Volts ... exponential (NR3)

\*1) Not provided for the VC-7502

\*2) only for the VC-7502

The command syntax of the TRIGGER subsystem commands is shown below.

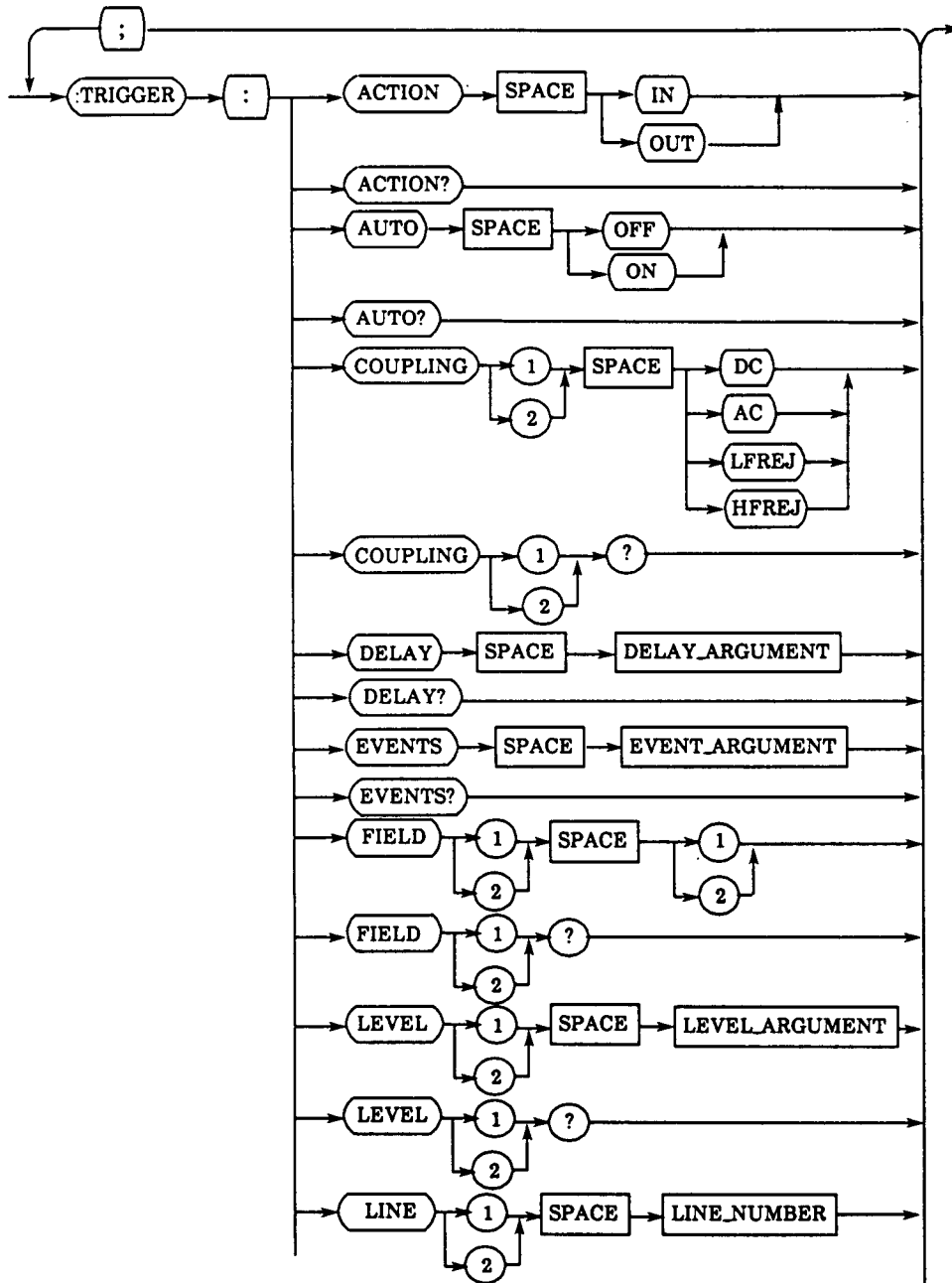

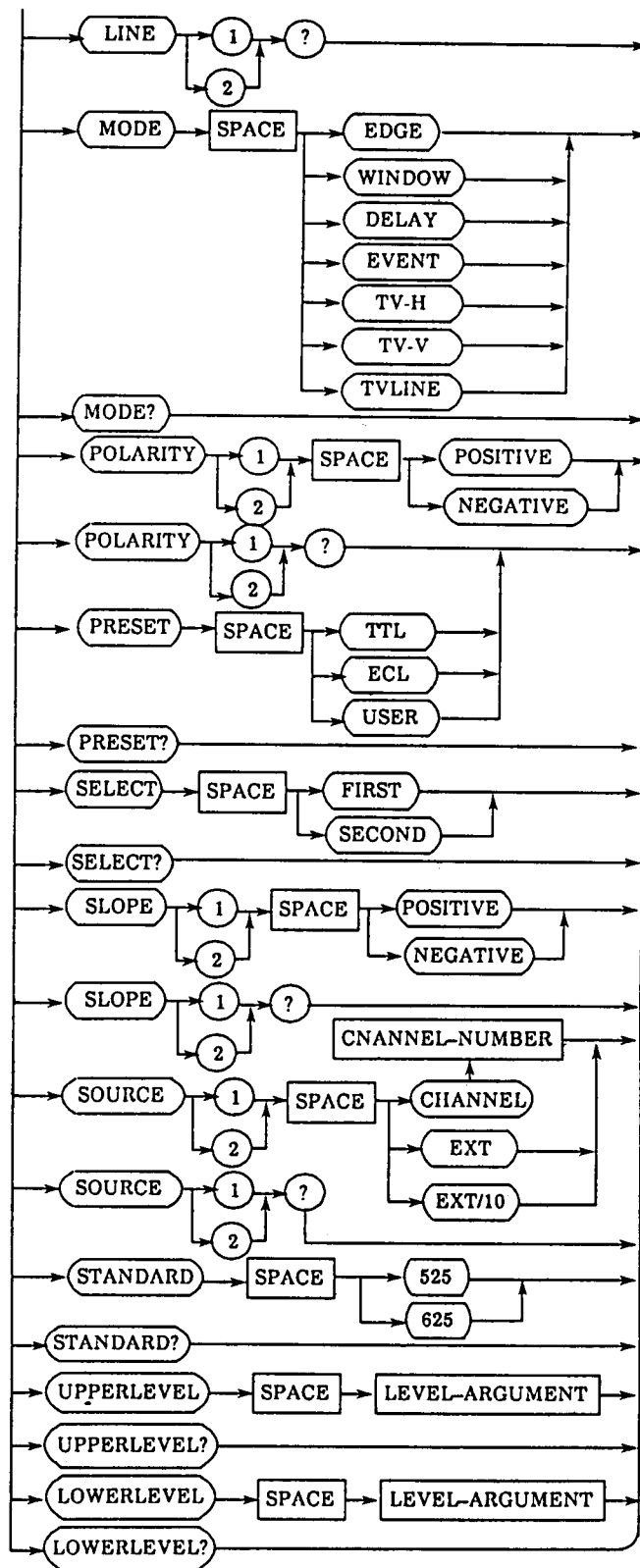

## (1)ACTION \_\_\_\_\_command/query

The ACTION command sets whether the instrument is triggered when a signal comes into (IN) the trigger level range or the signal goes out of (OUT) the trigger level range in the window trigger function mode.

Command syntax  
:TRIGGER:ACTION {IN | OUT}

Query syntax  
:TRIGGER:ACTION?

Returned format  
{IN | OUT}

Example  
PRINT #1,":TRIGGER:ACTION IN"

Example  
PRINT #1,":TRIGGER:ACTION?"  
INPUT#1,ACTIONS

## (2)AUTO \_\_\_\_\_command/query

The AUTO command turns on/off auto trigger.

Command syntax  
:TRIGGER:AUTO {ON | OFF}

Query syntax  
:TRIGGER:AUTO?

Returned format  
{ON | OFF}

Example  
PRINT #1,":TRIGGER:AUTO ON"

Example  
PRINT #1,":TRIGGER:AUTO?"  
INPUT #1,AUTOS

Auto trigger is turned on.

## (3)COUPLING < N > \_\_\_\_\_command/query

The COUPLING <N> command sets the coupling system connecting the trigger source signal to the trigger circuit in the edge trigger function mode.

Command syntax  
:TRIGGER:COUPLING{1 | 2} {DC | AC | LFREJ | HFREJ}

Query syntax  
:TRIGGER:COUPLING{1 | 2}?

Returned format  
{DC | AC | LFREJ | HFREJ}

Example  
PRINT #1,":TRIGGER:COUPLING1 DC"

Example  
PRINT #1,":TRIGGER:COUPLING1?"  
INPUT #1,COUPLINGS

The coupling system of the 1st trigger is set to DC.

## (4)DELAY \_\_\_\_\_command/query

The DELAY command sets the delay time in the delay trigger function mode.

Command syntax  
:TRIGGER:DELAY <delay >

Query syntax  
:TRIGGER:DELAY?

Returned format  
<delay >



Where, <delay> :: = Delay time (second)

Example  
PRINT #1,":TRIGGER:DELAY 32E-6"

The delay time is set to 32 $\mu$ s.

Example  
PRINT #1,":TRIGGER:DELAY?"  
INPUT#1,DELAYS

## (5)EVENTS \_\_\_\_\_command/query

The EVENT command sets the number of events in the event trigger function mode.

Command syntax  
:TRIGGER:EVENTS <event>

Query syntax  
:TRIGGER:EVENTS?

Returned format  
<event>

Where, <event> :: = Number of events

Example  
PRINT #1,":TRIGGER:EVENTS 123"

Example  
PRINT #1,":TRIGGER:EVENTS?"  
INPUT#1,EVENTS\$

## (6)FIELD < N > \_\_\_\_\_command/query

The FIELD<N> command sets the field in the TV LINE mode of the TV trigger function.

Command syntax  
:TRIGGER:FIELD{1 | 2}

Query syntax  
:TRIGGER:FIELD{1 | 2}?

Returned format  
{1 | 2}

Example  
PRINT #1,":TRIGGER:FIELD1 1"

Example  
PRINT #1,":TRIGGER:FIELD1?"  
INPUT#1,FIELDS\$

## (7)LEVEL < N > \_\_\_\_\_command/query

The LEVEL<N> command switches the trigger level voltage.

Command syntax  
:TRIGGER:LEVEL{1 | 2} <level>

Query syntax  
:TRIGGER:LEVEL{1 | 2}?

Returned format  
<level>

Where, <level> :: = Trigger level voltage (Volt) (NR3)

Example  
PRINT #1,":TRIGGER:LEVEL1 1E-3"

Example  
PRINT #1,":TRIGGER:LEVEL1?"  
INPUT#1,LEVEL\$

The trigger level voltage is switched to 1mV.

The present trigger level voltage is returned.

## (8)LINE < N > \_\_\_\_\_ command/query

The LINE < N > command sets the line number in the TV LINE mode of the TV trigger function.

Command syntax  
:TRIGGER:LINE{1 | 2} < line >

Query syntax  
:TRIGGER:LINE{1 | 2}?

Returned format  
< line >

Where, < line > :: = Line number (1~625)

Example  
PRINT #1,":TRIGGER:LINE1 123"

Example  
PRINT #1,":TRIGGER:LINE1?"  
INPUT #1,LINES\$

## (9)MODE \_\_\_\_\_ command/query

The MODE command switches the trigger mode.

Command syntax  
:TRIGGER:MODE {EDGE | WINDOW |  
DELAY | EVENT | TV-H | TV-V | TVLINE}

Query syntax  
:TRIGGER:MODE?

Returned format  
{EDGE | WINDOW | DELAY |  
EVENT | TV-H | TV-V | TVLINE}

Example  
PRINT #1,":TRIGGER:MODE EDGE"

Example  
PRINT #1,":TRIGGER:MODE?"  
INPUT#1,MODE\$

The trigger mode is switched to EDGE.

The present trigger mode is returned.

## (10)POLARITY < N > \_\_\_\_\_ command/query

The PLARITY < n > command sets the polarity of the trigger signal.

Command syntax  
:TRIGGER:POLARITY{1 | 2} {POSITIVE | NEGATIVE}

Query syntax  
:TRIGGER:POLARITY{1 | 2}?

Returned format  
{POSITIVE | NEGATIVE}

Example  
PRINT #1,":TRIGGER:POLARITY1 POSITIVE

Example  
PRINT #1,":TRIGGER:POLARITY1?"  
INPUT#1,POLARITY\$

The polarity of the trigger signal is switched to EDGE.

The present polarity of the trigger signal  
is returned.

### (11)PRESET \_\_\_\_\_command/query

The PRESET command sets the trigger level in the event trigger or delay trigger function mode.

Command syntax  
:TRIGGER:PRESET {TTL | ECL | USER}

Query syntax  
:TRIGGER:PRESET?

Returned format  
{TTL | ECL | USER}

Example  
PRINT #1,":TRIGGER:PRESET ECL"

The trigger level is switched to ECL.

Example  
PRINT #1,":TRIGGER:PRESET?"  
INPUT#1,PRESET\$

The present trigger level selection is returned.

### (12)SELECT \_\_\_\_\_command/query

The SELECT command switches the trigger setup.

Command syntax  
:TRIGGER:SELECT {FIRST | SECOND}

Query syntax  
:TRIGGER:SELECT?

Returned format  
{FIRST | SECOND}

Example  
PRINT #1,":TRIGGER:SELECT FIRST"

The trigger setup is switched to the first.

Example  
PRINT #1,":TRIGGER:SELECT?"  
INPUT#1,SELECT\$

The present trigger setup is returned.

### (13)SLOPE < n > \_\_\_\_\_command/query

The SLOPE command switches the trigger slope.

Command syntax  
:TRIGGER:SLOPE{1|2} {POSITIVE | NEGATIVE}

Query syntax  
:TRIGGER:SLOPE{1|2}?

Returned format  
{POSITIVE | NEGATIVE}

Example  
PRINT #1,":TRIGGER:SLOPE1 POSITIVE"

The trigger slope is switched to "+".

Example  
PRINT #1,":TRIGGER:SLOPE1?"  
INPUT#1,SLOPE\$

The present trigger slope is returned.

### (14)SOURCE < N > \_\_\_\_\_command/query

The SOURCE <N> command switches the trigger source.

(VC-7502 is not provided with CHANNEL 3 | 4, EXT | EXT/10 only for the VC-7502)

Command syntax  
:TRIGGER:SOURCE{1 | 2} CHANNEL{1 | 2 | 3 | 4  
| EXT | EXT/10}

Query syntax  
:TRIGGER:SOURCE{1 | 2}?

Returned format  
CHANNEL{1 | 2 | 3 | 4 | EXT | EXT/10}

Example  
PRINT #1,":TRIGGER:SOURCE1 CHANNEL4"

The trigger source is switched to CH4.

Example  
PRINT #1,":TRIGGER:SOURCE1?"  
INPUT#1,SOURCES

The present trigger source is returned.

### (15)STANDARD \_\_\_\_\_command/query

The STANDARD command sets the type of the TV signal in the TV LINE mode of the TV trigger function.

Command syntax  
:TRIGGER:STANDARD {525 |625}

Example  
PRINT #1,":TRIGGER:STANDARD 525"

The type of the TV signal is switched to the 525 TV lines.

Query syntax  
:TRIGGER:STANDARD?

Returned format  
{525 |625}

Example  
PRINT #1,":TRIGGER:STANDARD?"  
INPUT #1,STANDARD\$

The type of the present TV signal is returned.

### (16)UPPERLEVEL \_\_\_\_\_command/query

The UPPERLEVEL command switches the upper trigger level voltage in the window trigger mode.

Command syntax  
:TRIGGER:UPPERLEVEL <level>

Where, <level> :: = trigger level voltage(NR3)

Example  
PRINT #1,":TRIGGER:UPPERLEVEL 1E-3"

The trigger level voltage is switched to 1mvolt.

Query syntax  
:TRIGGER:UPPERLEVEL?

Returned format  
<level>

Example  
PRINT #1,":TRIGGER:UPPERLEVEL?"  
INPUT #1,LEVEL\$

The trigger level voltage value is returned.

### (17)LOWERLEVEL \_\_\_\_\_command/query

The LOWERLEVEL command switches the lower trigger level voltage in the window trigger mode.

Command syntax  
:TRIGGER:LOWERLEVEL <level>

Where, <level> :: = trigger level voltage(NR3)

Query syntax  
:TRIGGER:LOWERLEVEL?

Returned format  
<level>

### 8.3.10 WAVEFORM Commands.

The WAVEFORM subsystem commands control the transmission of waveform data acquired by the instrument.

The following WAVEFORM subsystem commands can be used in the instrument.

command header	command	program data
	/query	
:WAVEFORM:DATA	q	-
:WAVEFORM:FORMAT	c/q	"BYTE", "ASCII"
:WAVEFORM:POINTS	c/q	-
:WAVEFORM:SOURCE	c/q	"CHANNEL1", "CHANNEL2", "CHANNEL3"*; "CHANNEL4"*; "FUNCTION1", "FUNCTION2"
:WAVEFORM:XINCREMENT	q	-
:WAVEFORM:XORIGIN	q	-
:WAVEFORM:XREFERENCE	q	-
:WAVEFORM:YINCREMENT	q	-
:WAVEFORM:YORIGIN	q	-
:WAVEFORM:YREFERENCE	q	-
:WAVEFORM:SEGMENT	c/q	1~2000(VC-7524 only)
:WAVEFORM:START	c/q	1~2047999(VC-7524 only) 1~8191(VC-7502/ VC-7504)

\*) Not provided for the VC-7502

The command syntax of the WAVEFORM subsystem is shown below.

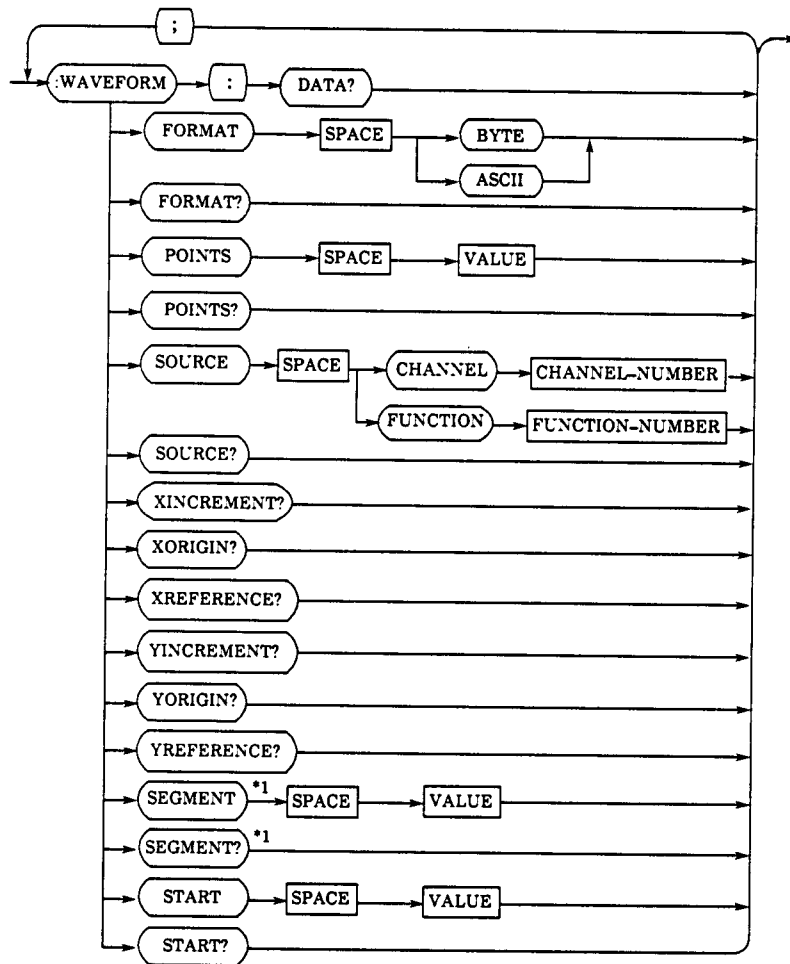

\*1 VC-7524 only

## (1)DATA \_\_\_\_\_ query

The DATA command returns the waveform data.

Query syntax  
:WAVEFORM:DATA?

Returned format  
< block-data >

Where, < block\_data > ::= #80000 XXXX < binarydata >

Example  
Refer to item 8.5.

## (2)FORMAT \_\_\_\_\_ command/query

The FORMAT command sets the waveform format. (BYTE fixed)

Command syntax  
:WAVEFORM:FORMAT {BYTE | ASCII}

Query syntax  
:WAVEFORM:FORMAT?

Returned format  
{BYTE | ASCII}

Example  
PRINT #1,":WAVEFORM:FORMAT BYTE"

Example  
PRINT #1,":WAVEFORM:FORMAT?"  
INPUT #1,FORMAT\$

The waveform data format is set to BYTE.

The present data format is returned.

## (3)POINTS \_\_\_\_\_ command/query

The POINTS command sets the number of returned waveform data.

Command syntax  
:WAVEFORM:POINTS <point >

Query syntax  
:WAVEFORM:POINTS?

Returned format  
<point >

Where,  
VC-7504/VC-7502  
<point >:: = 1 ~ 8192  
VC-7524  
<point >:: = 1 ~ 2048000

Example  
PRINT #1,":WAVEFORM:POINTS 1024"

Example  
PRINT #1,":WAVEFORM:POINTS?"  
INPUT #1,POINT\$

The number of returned waveform data is set to 1024.

The present number of returned waveform data is returned.

## (4)SOURCE \_\_\_\_\_ command/query

The SOURCE command sets the source channel of the returned waveform data.  
(VC-7502 is not provided with CHANNEL 3 | 4 )

Command syntax  
:WAVEFORM:SOURCE {CHANNEL{1 | 2 | 3 | 4} |  
FUNCTION{1 | 2}}

Query syntax  
:WAVEFORM:SOURCE?

Returned format  
{CHANNEL{1 | 2 | 3 | 4} | FUNCTION{1 | 2}}

Example  
PRINT #1,":WAVEFORM:SOURCE CHANNEL1"

Example  
PRINT #1,":WAVEFORM:SOURCE?"  
INPUT#1,SOURCE\$

The source channel is set to channel 1.

The present source channel is returned.

## **(5)XINCREMENT**\_\_\_\_\_query

The XINCREMENT command returns the sample period per point of waveform data in the memory area.

Query syntax  
:WAVEFORM:XINCREMENT?

Returned format  
< value >

Where, < value > :: = Sample period (second) (NR3)

Example  
PRINT #1,":WAVEFORM:XINCREMENT?"

The present sample period is returned.

## **(6)XORIGIN**\_\_\_\_\_query

The XORIGIN command returns the DELAY time of waveform data in the memory area.

Query syntax  
:WAVEFORM:XORIGIN?

Returned format  
< value >

Where, < value > :: = DELAY time (second) (NR3)

Example  
PRINT #1,":WAVEFORM:XORIGIN?"  
INPUT #1,XORIGINS

The delay returned time of present waveform data in the memory area is

## **(7)XREFERENCE**\_\_\_\_\_query

The XREFERENCE command returns the data position corresponding to XORIGIN.

Query syntax  
:WAVEFORM:XREFERENCE?

Returned format  
< value >

Where, < value > :: = Data position (second)

Example  
PRINT #1,":WAVEFORM:XREFERENCE?"

The data position corresponding to the present XORIGIN is returned.



## **(8)YINCREMENT** \_\_\_\_\_ **query**

The YINCREMENT command sets GAIN per point of waveform data in the memory area.

Query syntax  
:WAVEFORM:YINCREMENT?

Returned format  
< value >

Where, < value > :: = GAIN (Volt) (NR3)

Example  
PRINT #1,":WAVEFORM:YINCREMENT?"  
INPUT #1,VALUES

The GAIN per point of present waveform data in the memory area is returned.

## **(9) YORIGIN** \_\_\_\_\_ **query**

The YORIGIN command sets OFFSET of waveform data in the memory area.

Query syntax  
:WAVEFORM:YORIGIN?

Returned format  
< value >

Where, < value > :: = OFFSET (Volt) (NR3)

Example  
PRINT #1,":WAVEFORM:YORIGIN?"  
INPUT #1,VALUES

The OFFSET of present waveform data in the memory area is returned.

## **(10)YREFERENCE** \_\_\_\_\_ **query**

The YREFERENCE command returns the data value corresponding to YORIGIN.

Query syntax  
:WAVEFORM:YREFERENCE?

Returned format  
< value >

Where, < value > :: = Data value

Example  
PRINT #1,":WAVEFORM:YREFERENCE?"  
INPUT #1,YREFERENCES

The data value corresponding to present YORIGIN is returned.

**(11)SEGMENT(VC-7524 only)**\_\_\_\_\_ **command/query**

Set the segment of the waveform returned in the memory split mode.

Command syntax  
:WAVEFORM:SEGMENT < seg >

Query syntax  
:WAVEFORM:SEGMENT?

Returned format  
< seg >

Where: < seg > :: = 1 ~ 2000

**(12)START**\_\_\_\_\_ **command/query**

Set the start point of the returned waveform.

Command syntax  
:WAVEFORM:START < point >

Query syntax  
:WAVEFORM:START?

Returned format  
< point >

Where: < point > :: = 0 ~ 2047999 (VC-7524 only)  
0 ~ 8191 (VC-7502/VC-7504)

### 8.3.11 FUNCTION Commands

The FUNCTION subsystem commands control the waveform operation function of the instrument. The following FUNCTION subsystem commands can be used in the instrument.

command header	command	program data
:FUNCTION <N>:OPERAND <N>	c/q	"CHANNEL1", "CHANNEL2", "CHANNEL3"; "CHANNEL4"*
:FUNCTION <N>:OPERATOR	c/q	"INVERT", "ABSOLUTE", "ADD", "SUBTRACT", "MULTIPLY", "VERSUS"

\*) Not provided for the VC-7502

The command syntax of the FUNCTION subsystem command is shown below.

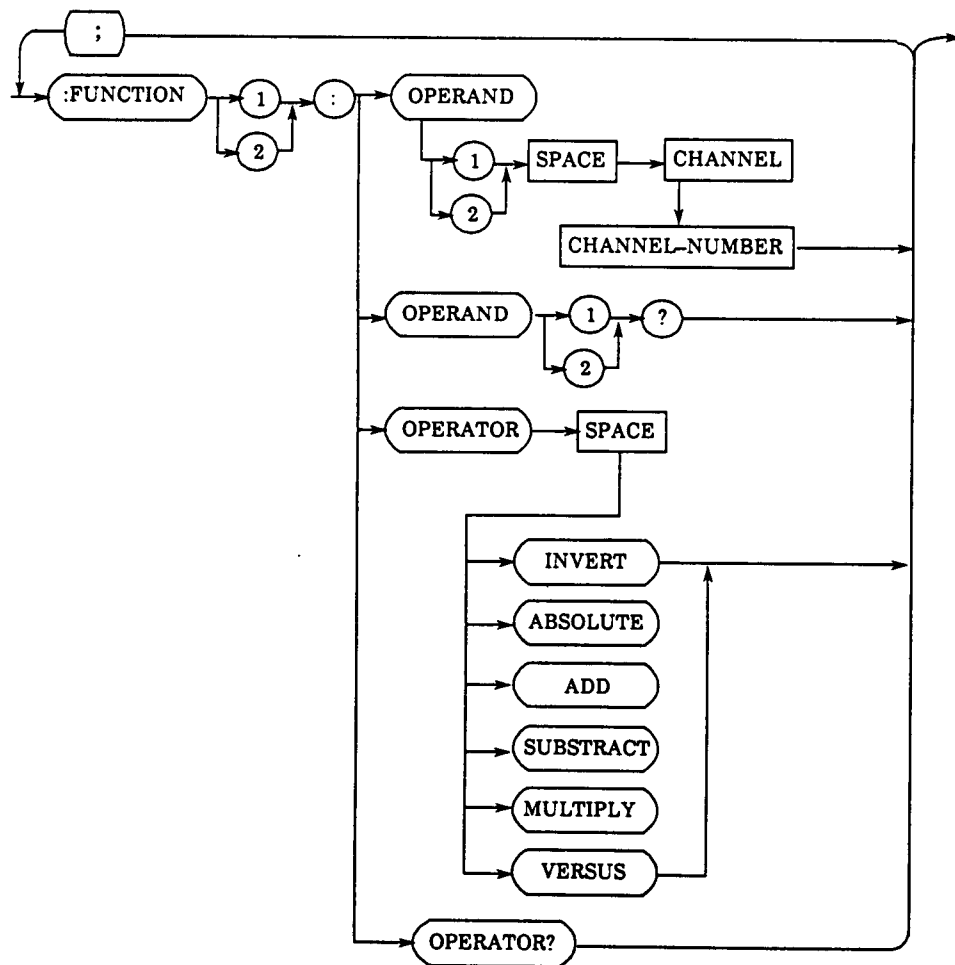

**(1)OPERAND < N > \_\_\_\_\_ command/query**

The OPERAND <N> command sets the operand of the specified function.  
(VC-7502 is not provided with CHANNEL 3 | 4)

Command syntax  
:FUNCTION{1 | 2}:OPERAND{1 | 2}  
CHANNEL{1 | 2 | 3 | 4 }

Query syntax  
:FUNCTION{1 | 2}:OPERAND{1 | 2}?

Returned format  
CHANNEL{1 | 2 | 3 | 4}

Example  
PRINT #1,":FUNCTION1:OPERAND2  
CHANNEL4"

Example  
PRINT #1,":FUNCTION1:OPERAND1?"  
INPUT#1,OPERAND1\$

The operand 2 of the present function 1 is set to CH4.

The operand 1 of the present function 1 is returned.

**(2)OPERATOR \_\_\_\_\_ command/query**

The OPERATOR command sets the operand of the specified function.

Command syntax  
:FUNCTION{1 | 2}:OPERATOR {INVERT | ABSOLUTE |  
ADD | SUBTRACT | MULTIPLY | VERSUS}

Query syntax  
:FUNCTION{1 | 2}:OPERATOR?

Returned format  
{ INVERT | ABSOLUTE | ADD |  
SUBTRACT | MULTIPLY | VERSUS}

Example  
PRINT #1,":FUNCTION1:OPERATOR ADD"

Example  
PRINT #1,":FUNCTION1:OPERATOR?"  
INPUT #1,OPERATORS

The operator of the function 1 is set to ADD.

The operator of the present function 1 is returned.

### 8.3.12 HARDCOPY Commands

The HARDCOPY subsystem commands control the plot output function of the instrument. The following HARDCOPY subsystem commands can be used in the instrument.

command header	command	program data
:HARDCOPY:MODE	c/q	"ALL", "WAVEFORM", "GRATICULE", "FACTOR"
:HARDCOPY:PAPER	c/q	"A3", "A4"
:HARDCOPY:PENCHANGE	c/q	"ON", "OFF"
:HARDCOPY:POSITION	c/q	"AUTO", "1", "2", "3", "4", "5", "6", "7", "8"
:HARDCOPY:SIZE	c/q	"A3", "A4", "A5", "A6"

The command syntax of the HARDCOPY subsystem commands is shown below.

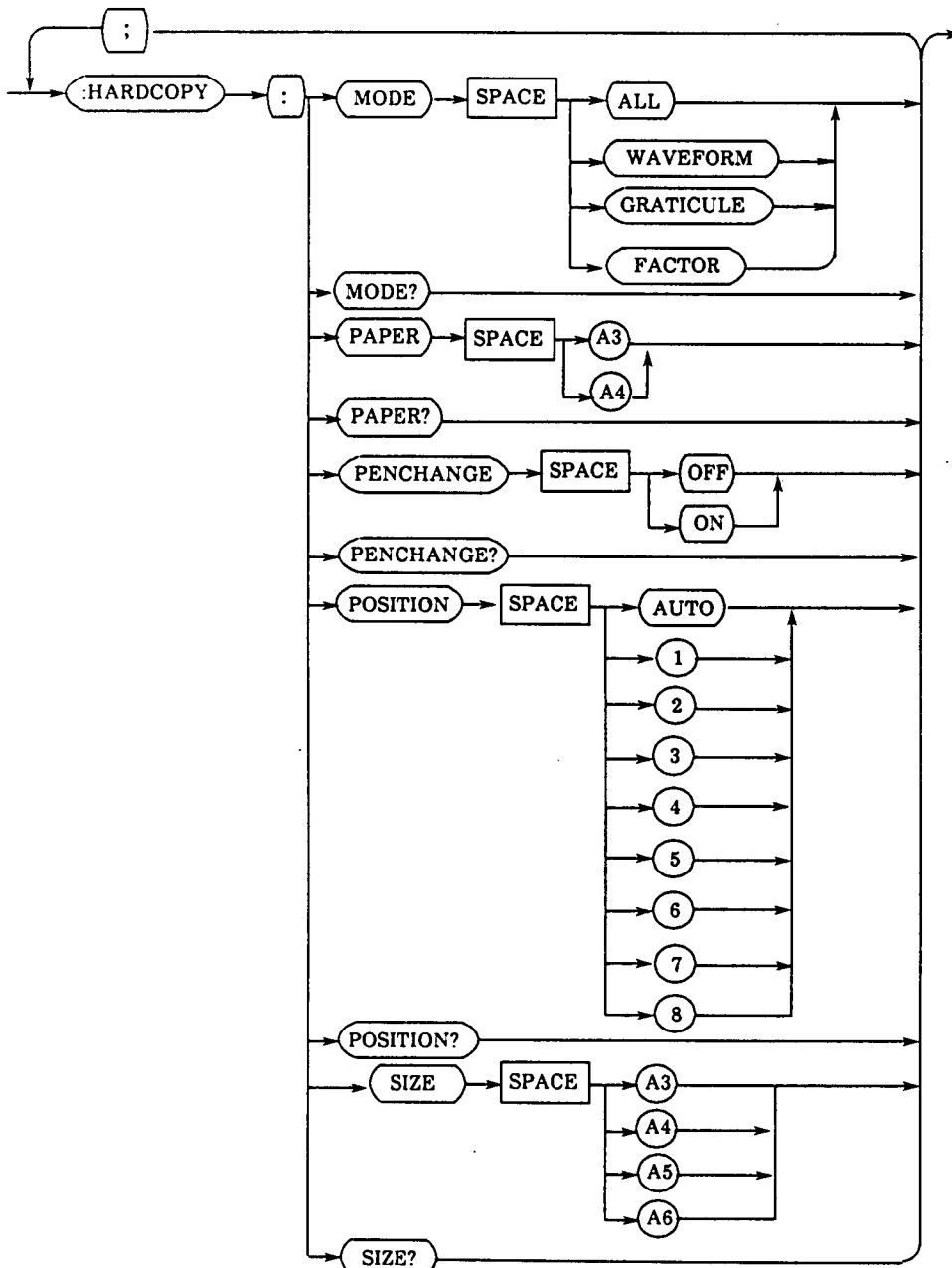

## (1)MODE\_\_\_\_\_command/query

The MODE command sets the items to be plotted in the plot output function mode.

### Command syntax

```
:HARDCOPY:MODE {ALL | WAVEFORM |  
GRATICULE | FACTOR}
```

### Example

```
PRINT#1,":HARDCOPY:MODE ALL"
```

The items to be plotted are set to "all"  
in the plot output function mode.

### Query syntax

```
HARDCOPY:MODE?
```

### Returned format

```
{ALL | WAVEFORM |  
GRATICULE | FACTOR}
```

### Example

```
PRINT #1,":HARDCOPY:MODE?"  
INPUT#1,MODE$
```

The present items to be plotted are returned.

## (2)PAPER\_\_\_\_\_command/query

The PAPER command sets the paper size in the plot output function mode.

### Command syntax

```
:HARDCOPY:PAPER {A3 | A4 }
```

### Example

```
PRINT #1,":HARDCOPY:PAPER A4"
```

The paper size is set to A4.

### Query syntax

```
:HARDCOPY:PAPER?
```

### Returned format

```
{A3 | A4 }
```

### Example

```
PRINT #1,":HARDCOPY:PAPER?"  
INPUT#1,PAPER$
```

The present paper size is returned.

## (3)PENCHANGE\_\_\_\_\_command/query

The PENCHANGE command establishes the pen change mode in the plot output function mode.

### Command syntax

```
:HARDCOPY:PENCHANGE {ON | OFF}
```

### Example

```
PRINT #1,":HARDCOPY:PENCHANGE ON"
```

The pen change mode is turned on.

### Query syntax

```
:HARDCOPY:PENCHANGE?
```

### Returned format

```
{ON | OFF}
```

### Example

```
PRINT #1,":HARDCOPY:PENCHANGE?"  
INPUT #1,PENCHANGE$
```

The present pen change mode is returned.

## (4)POSITION\_\_\_\_\_command/query

The POSITION command sets the plot position in the plot output function mode.

### Command syntax

```
:HARDCOPY:POSITION {AUTO | 1 | 2 | 3 | 4 | 5 | 6 | 7 |  
8}
```

### Query syntax

```
:HARDCOPY:POSITION?
```

### Returned format

```
{AUTO | 1 | 2 | 3 | 4 | 5 | 6 | 7 | 8}
```

Example  
PRINT #1,":HARDCOPY:POSITION AUTO"

The plot position is set to AUTO.

Example  
PRINT #1,":HARDCOPY:POSITION?"  
INPUT#1,POSITION\$

The present plot position is returned.

**(5)SIZE \_\_\_\_\_command/query**

The SIZE command sets the plot size in the plot output function mode.

Command syntax  
:HARDCOPY:SIZE {A3 | A4 | A5 | A6}

Example  
PRINT #1,":HARDCOPY:SIZE A3"

The plot size is set to A3.

Query syntax  
:HARDCOPY:SIZE?

Returned format  
{A3 | A4 | A5 | A6}

Example  
PRINT #1,":HARDCOPY:SIZE?"  
INPUT#1,SIZES

The present plot size is returned.

### 8.3.13 GO-NOGO Commands

The GO-NOGO subsystem commands control the GO-NOGO judgment function of the instrument. The following GO-NOGO subsystem commands can be used in the instrument.

command header	command	program data
	/query	
:GO-NOGO:MODE	c/q	"ON", "OFF"
:GO-NOGO:SOURCE	c/q	"CHANNEL1", "CHANNEL2", "CHANNEL3", "CHANNEL4", "FUNCTION1", "FUNCTION2"
:GO-NOGO:CONDITION	c/q	"APART", "ALL"
:GO-NOGO:DIRECTION	c/q	"IN", "OUT"
:GO-NOGO:REACTION	c/q	"NONE","HOLD","SAVE","PRINT","SRQ"
:GO-NOGO:START	c/q	-250~250
:GO-NOGO:STOP	c/q	-250~250

\*) Not provided for the VC-7502

The command syntax of the GO-NOGO subsystem command is shown below.

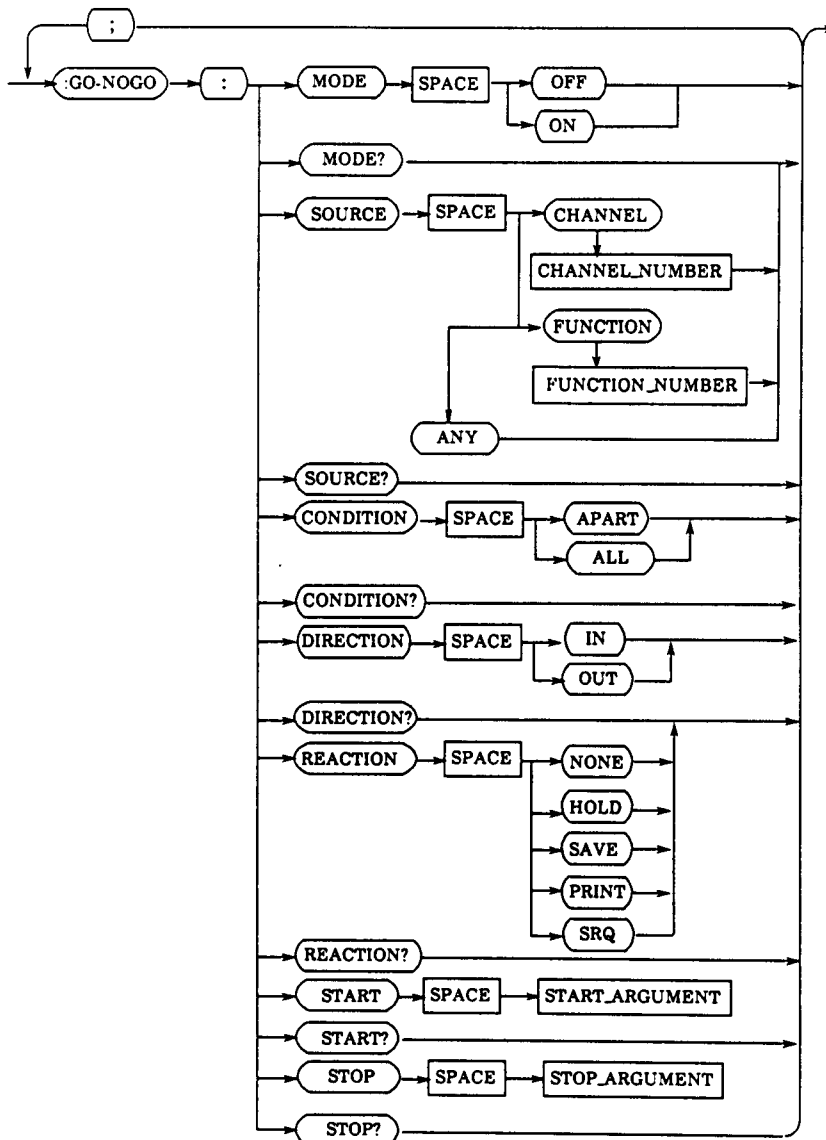



## (1)MODE \_\_\_\_\_command/query

The MODE command sets the GO-NOGO judgment function to ON/OFF.

Command syntax  
:GO-NOGO:MODE{ON | OFF}

Query syntax  
:GO-NOGO:MODE?

Returned format  
{ON | OFF}

Example  
PRINT #1,":GO-NOGO:MODE ON"

Example  
PRINT #1,":GO-NOGO:MODE?"  
INPUT#1,MODE\$

The GO-NOGO judgment function is set to ON.

The setting of present GO-NOGO judgment function is returned.

## (2)SOURCE \_\_\_\_\_command/query

The SOURCE command sets a waveform to be measured of the GO-NOGO judgment function.  
(VC-7502 is not provided with CHANNEL 3 | 4 )

Command syntax  
:GO-NOGO:SOURCE {CHANNEL{1 | 2 | 3 | 4} |  
FUNCTION{1 | 2} | ANY}

Query syntax  
:GO-NOGO:SOURCE?

Returned format  
{CHANNEL{1 | 2 | 3 | 4} |  
FUNCTION{1 | 2} | ANY}

Example  
PRINT #1,":GO-NOGO:SOURCE CHANNEL1"

Example  
PRINT #1,":GO-NOGO:SOURCE?"  
INPUT#1,SOURCES\$

The waveform to be measured is set to channel 1.

The setting of the present waveform to be measured is returned.

## (3)CONDITION \_\_\_\_\_command/query

The CONDITION command switches between APART and ALL of the GO-NOGO judgment function.

Command syntax  
:GO-NOGO:CONDITION {APART | ALL}

Query syntax  
:GO-NOGO:CONDITION?

Returned format  
{APART | ALL}

Example  
PRINT #1,":GO-NOGO:CONDITION APART"

Example  
PRINT #1,":GO-NOGO:CONDITION?"  
INPUT#1,CONDITIONS\$

The mode is set to APART.

The setting of present APART/ALL is returned.

#### (4)DIRECTION \_\_\_\_\_command/query

The DIRECTION command switches between going out of (OUT) the GO-NOGO function and coming into (IN) the GO-NOGO function.

Command syntax  
:GO-NOGO:DIRECTION {IN | OUT}

Query syntax  
:GO-NOGO:DIRECTION?

Returned format  
{IN | OUT}

Example  
PRINT #1,":GO-NOGO:DIRECTION IN"

Example  
PRINT #1,":GO-NOGO:DIRECTION?"  
INPUT#1,DIRECTIONS

The mode is set to coming into (IN) the function. The present setting of going out of (OUT) the function/coming into (IN) the function is returned.

#### (5)REACTION \_\_\_\_\_command/query

The REACTION command sets the process after performing the GO-NOGO judgment function.

Command syntax  
:GO-NOGO:REACTION {NONE | HOLD |  
SAVE | PRINT | SRQ}

Query syntax  
:GO-NOGO:REACTION?

Returned format  
{NONE | HOLD | SAVE | PRINT | SRQ}

Example  
PRINT #1,":GO-NOGO:REACTION PRINT"

Example  
PRINT #1,":GO-NOGO:REACTION?"  
INPUT#1,REACTIONS

The process after judgment is set to printer output.

The present process after judgment is returned.

#### (6)START \_\_\_\_\_command/query

The START command sets the LEFT bar position of the Range of the GO-NOGO judgment

Command syntax  
:GO-NOGO:START <position >

Query syntax  
:GO-NOGO:STOP?

Returned format  
<position >

Where, <position > :: = -250 ~ 250

Example  
PRINT #1,":GO-NOGO:START -200"

Example  
PRINT #1,":GO-NOGA:START?"  
INPUT#1,START\$

The LEFT bar position is set to -200.

The present LEFT bar position is returned.

**(7)STOP** \_\_\_\_\_ **command/query**

The STOP command sets the RIGHT bar position of the Range of the GO-NOGO judgment function.

Command syntax  
:GO-NOGO:STOP <position>

Query syntax  
:GO-NOGO:STOP?

Returned format  
<position>

Where, <position> :: = -250~250

Example  
PRINT #1,":GO-NOGO:STOP 200"

Example  
PRINT#1,":GO-NOGA:STOP?"  
INPUT#1,STOP\$

The RIGHT bar position is set to 200.

### 8.3.14 MEMORYCARD Commands

The subsystem commands of the memory card input or output the data files in the IC memory card for this instrument.

In this instrument, the following subsystem commands of the memory card are used.

command header	command	
	/query	program data
:MEMORYCARD:DATA	c/q	-
:MEMORYCARD:DIR	q	-
:MEMORYCARD:SOURCE	c/q	-

The syntax of the sub system commands of the memory card is described below.

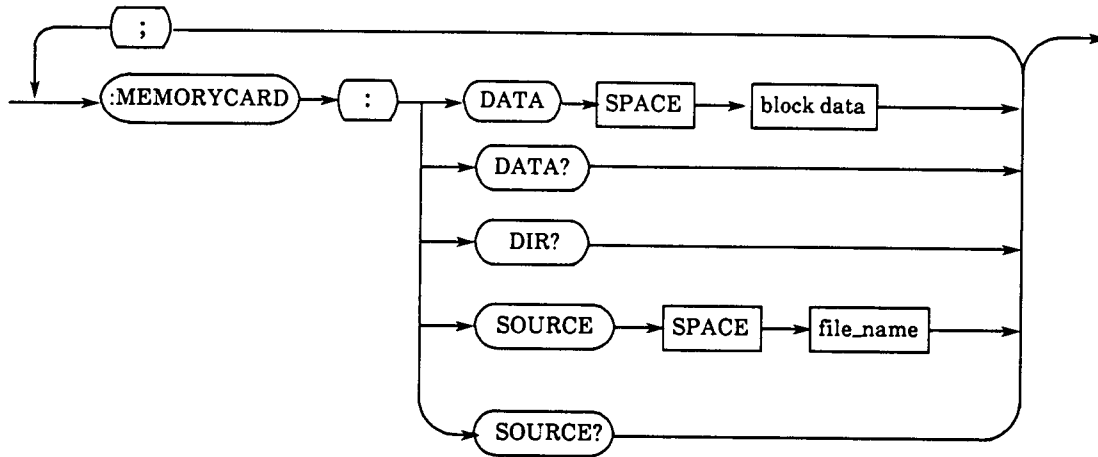

#### (1) DATA \_\_\_\_\_ command/query

The data in files are written and returned.

This command is not executed for the file whose size is larger than 18k.

Command syntax  
:MEMORYCARD:DATA {block data}

Query syntax  
:MEMORYCARD:DATA?

Returned format  
{block data}

#### Example

◀Quick Basic▶

```

DIM IWAVE$(3000)      'Definition of array.
OPEN "COM1:9600, N, 8, 1, LF, RS,"
FOR RANDOM AS #1      'Open the RS-232C (COM1)
PRINT #1, "MEMORY:
SOURCE WAVE0.DAT;"    'The memory source is set to
                        'wave0.dat.

PRINT #1,
"MEMORY:DATA?;"      'Transmits memory data
                        'receive command.

DAT$=INPUT$(1, #1)    'Reads "#".
PRINT DAT$            'Prints "#" to display.
  
```

```

STRLEN$ = INPUT$(1, #1) 'Reads "8".
PRINT STRLEN$          'Print "8" to display.
STRLEN = VAL(STRLEN$)  'Converts characters to figures.
FOR I = 1 TO STRLEN    'Starts to read block length
  BLEN$ = INPUT$(1, #1) 'Reads one character.
  BLOCKLEN$ =
  BLOCKLEN$ + BLEN$    'Adds acquire characters to
                        'character-string one by one.
NEXT
PRINT BLOCKLEN$        'Prints block length to display.
BLOCKLEN = VAL(LEFT$(
(BLOCKLEN$, STRLEN) ) 'Converts block length to figures.
FOR I = 1 TO BLOCKLEN  'Starts to read memory data.
  IWAVE$(I) = INPUT$(1, #1) 'Reads one byte.
NEXT
CLOSE #1               'Close the RS-232C (COM1).
END                    'End

```

## (2) DIR query

The contents of the route directly of the IC memory card are returned.

Query syntax  
:MEMORYCARD:DIR?

Returned format

< block data >

Where: < block data > ::= #80000XXXX < directorydata >

< directorydata >

①	②	③	④	⑤
WAVE1	DAT	8272	03-31-93	12:48
WAVE9999	DAT	753	03-31-93	2:10

15 File(s)      102400 bytes  
Returned with the above format.

- ① File name
- ② Extension
- ③ File size
- ④ Date
- ⑤ Time

Example

```

OPEN "COM1:9600,N,8,1,LF,RS,"
FOR RADOM AS #1      Open the RS-232C (COM1).
PRINT #1, ":MEMORY:DIR?;" 'Transmits receive command
                        'of content of directory.

DAT$ "INPUT$(1, #1)  'Reads "#".
STRLEN$ = INPUT$(1, #1) 'Reads "8".
STRLEN = VAL(STRLEN$)  'Converts characters to figures.
FOR I = 1 TO STRLEN    'Starts to read block length.
  BLEN$ = INPUT$(I < #1) 'Reads one character.
  BLOCKLEN$ =
  BLOCKLEN$ + BLEN$    'Adds acquire characters to
                        'character-string one by one.

```

```

NEXT
BLOCKLEN = VAL(LEFT$
(BLOCKLEN$,STRLEN) ) 'Converts block length to figures.
FOR I=0 TO BLOCKLEN 'Starts to read block data.
  FONT$ = INPUT$(1,#1) 'Reads one byte.
  PRINT FONT$; 'Display receive data.
NEXT
CLOSE #1 'Close the RS-232C (COM1).
END 'End.

```

### (3) SOURCE \_\_\_\_\_ command/query

The name of the file to which data are input and output is specified.

Command syntax  
:MEMORYCARD:SOURCE < file-name >

Query syntax  
:MEMORYCARD:SOURCE?

Returned format  
< file-name >

Where: < file-name > : : = XXXXXXXXXXX . XXX  
 ① File name (8 letters max.)  
 ② Extension (3 letters max.)  
 (An extension can be omitted.)

Example  
PRINT#1 , " : MEMORYCARD:SOURCE  
WAVE1 .DAT"

Example of programming  
PRINT# 1 , " :MEMORYCARD:SOURCE?"  
INPUT#1 ,SOURCE\$

## 8.4 Status report function

For the situation of errors caused by a programming function, refer to Fig. 8-2 Data structure of status report function.

Each register in the figure can be set/returned by a common command.

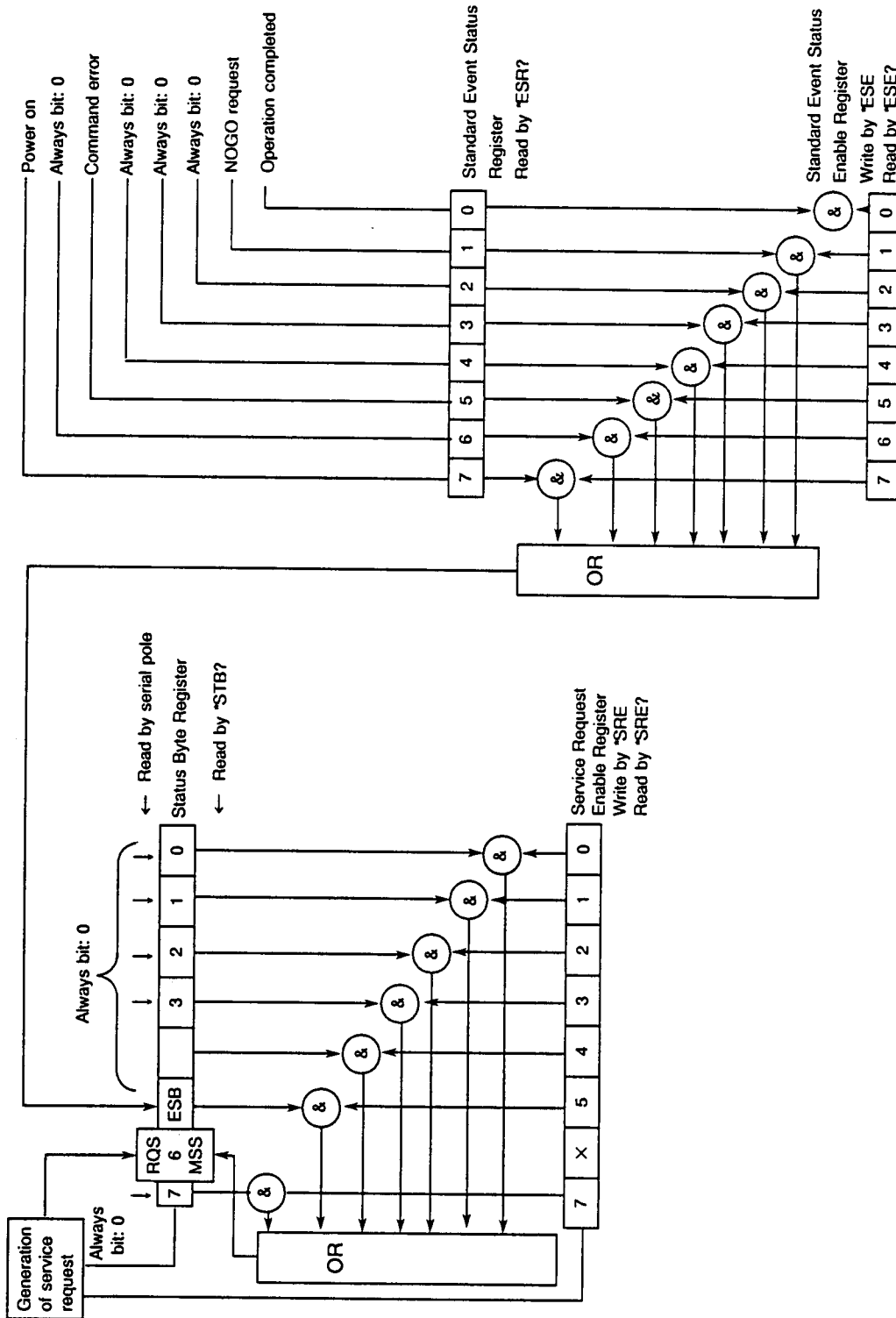

Fig. 8-2 Data structure of status report function

## 8.5 Programming example of receiving waveform data

```

<<Quick Basic>>
DIM IWAVE$(3000)           'Definition of array.
SCREEN 2                   'Sets the screen mode.
CLS 0                      'Clear screen.
WINDOW (0, 0)-(2048, 356) 'Sets the window.
LINE (0, 100)-(2048, 356), , B 'Sets the grid.
OPEN "COM1:9600,N,8,1,LF,
RS, "FOR RANDOM AS #1     'Open the RS-232C (COM1).
PRINT #1, ":TIMEBASE:RANGE 10M" '1ms/div
PRINT #1, ":VIEW CHANNEL2" 'Change to CHANNEL2.
PRINT #1, ":WAVEFORM:
SOURCE CHANNEL2"         'The source channel is set to
                           'channel2.

PRINT #1, ":WAVEFORM:
POINTS 2048"            'Specifying number of
                           'waveform data.

PRINT #1, ":DIGITIZE"    'Setting for single shot mode.
PRINT #1, ":WAVEFORM:DATA?" 'Transmits waveform data receive command.
DAT$=INPUT$(1, #1)       'Reads "#".
PRINT DAT$               'Prints "#" to display.
STRLEN$=INPUT$(1, #1)    'Reads "8".
PRINT STRLEN$            'Prints "8" to display.
STRLEN=VAL(STRLEN$)      'Converts characters to figures.
FOR I=1 TO STRLEN        'Starts to read block length.
  BLEN$=INPUT$(1, #1)    'Reads one character.
  BLOCKLEN$=
  BLOCKLEN$+BLEN$        'Adds acquire characters to
                           'character-string one by one.

NEXT

PRINT BLOCKLEN$          'Prints block length to display.
BLOCKLEN=VAL(LEFT$
(BLOCKLEN$, STRLEN) )   'Converts block length to figures.
FOR I=0 TO BLOCKLEN     'Starts to read waveform data.
  IWAVE$(I)=INPUT$(1, #1) 'Reads one byte.
NEXT

CLOSE #1                'Close the RS-232C(COM1).
FOR I=0 TO BLOCKLEN     'Starts to print waveform data
                           'to display.
  DAT=ASC(IWAVE$(I) )   'Converts waveform data to
                           'character code.

LINE (I, 100 + DAT)-
(I+1.100 + DAT + 1), , B 'Prints waveform data to display
NEXT
END                       'End.
```



## 8.6 Major causes for improper data transfer

- (1) The cable is not connected, or the system is not turned on.  
(\*1)
  - (2) The function command does not agree with the command of this oscilloscope.
  - (3) The set address of this oscilloscope does not agree with the address specified from the controller, or there is the same address of another instrument.
  - (4) Delimiters do not agree with each other, or the delimiter is not in the format of this oscilloscope. The delimiter used when a controller sends data (message) does not agree with the delimiter used when the controller receives data. (Example: sending: C/R, EOI, receiving: C/R, L/F)
  - (5) A function which is not available with this oscilloscope is attempted to execute. (Example: PPC, GET, TCT, etc.)
  - (6) There is no enough buffer area for data. (A large amount of data is requested to transfer to this oscilloscope even if the listener has only a small buffer area.)
  - (7) In serial pole, the address of the status register for detecting SRQ of the control line is specified in error.
  - (8) There is an error in the program statement, or the use of hexadecimal and decimal.
- \*1 When the instrument is turned off, it naturally does not work. When more than one instrument is connected through GPIB and an instrument which is not in use is turned off, the noise margin of the bus line may lower to cause misoperation. It is recommended to remove the instrument not in use from the system or turn on the instrument even not in use.

When data transfer is not successful, check the above again.

# CHAPTER 9 SPECIFICATIONS

## 9.1 Electrical

The following specifications are applicable to the VC-7524/VC-7504 and the VC-7502 unless otherwise noted.

### VERTICAL DEFLECTION SYSTEM

Resolution	8 bits
Sensitivity	2mV/div-5V/div in 11 steps
Accuracy	±3%
Bandwidth (-3dB)	
Single shot	DC-25MHz (AC Coupling 10Hz-25MHz)
Repetitive	DC-150MHz (AC Coupling 10Hz-150MHz)
Low frequency limit in AC coupling	10Hz
No. of Input Channels	4 channels(2 channels for the VC-7502)
Input withstand voltage	400V (DC + AC peak at 1kHz)
Input Coupling	DC, AC, GND
Input Impedance	1MΩ ± 1.5% / 15pF ± 3pF
Max. INput Voltage Phase error between channels	40ps (Skew adjustment ± 5ns)
Operating system	Display of a waveform can be turned on/off for each channel.

### HORIZONTAL DEFLECTION SYSTEM

Max. Sampling speed	100MS/s (4 channels simultaneously) (2 channels simultaneously for the VC-7502)
Acquisition Memory	8kW/CH, 2Mw/CH (VC-7524 only)
Sweep Time	
Equivalent Sampling	2ns/div-0.2μs/div ± 1%
Realtime Sampling	0.5μs/div-50s/div, 0.5μs/div-1000s/div(VC-7524 only), ± 0.04%
Roll mode	0.2s/div-50s/div, 0.2s/div-1000s/div(VC-7524 only), ± 0.25%
Record length	Max. 8kW/CH, 2MW/CH(VC-7524 only) (depend on mode)
Pre-trigger	Max. 10 div
Post-trigger	Max. 500div

### TRIGGER SYSTEM

Source	CH1, CH2, CH3, CH4 for the VC-7524/VC-7504 CH1, CH2, EXT, EXT ÷ 10 for the VC-7502
Mode	AUTO, NORM
Coupling	DC, AC, HFrej, LFrej
Slope	+/-
Sensitivity	

Frequency	CH1, CH2, CH3*, CH4* (* Not provided for the VC-7502)		EXT(VC-7502 only)	
	2mV,5mV/div	10mV~5V/div	÷ 1	÷ 10
DC~20MHz	More than 5mVp-p	More than 0.5div	More than 50mVp-p	More than 0.5Vp-p
20MHz~150MHz	More than 10mVp-p	More than 1.0div	More than 0.1Vp-p	More than 1Vp-p

AC cutoff frequency	10Hz (-3dB)
HF/LF cutoff frequency	50kHz (-3dB) approx.
Auto Lower frequency	20Hz
Trigger function	
Trigger setup:	Two trigger setup memoies provided.
Window trigger:	Outside window or Inside window trigger provided.
Trigger after events:	Triggered after preset number of "2nd" triggers occurs after generation of "1st" trigger <ul style="list-style-type: none"> <li>• No. of events: 2-4097</li> <li>• 2nd trigger Bandwidth: less than 30MHz</li> </ul>
Trigger after delay:	Triggered by "2nd" trigger generated after elapse of delay time following "1st" trigger
TV-trigger:	
Mode	TV-V, TV-H, TV-LINE
Sensitivity	More than 1 div (at SYNC section)
Line Selector	525/625 LINE system selectable ODD/EVEN Field selectable LINE select

## OPERATING MODE

	Number of acquired data	Number of displayed data
NORMAL mode	512W/CH	512W/CH
HIGH DENSITY mode	8kW/CH	8kW/CH
LONG mode (VC-7524 only)	2MW/CH (MAX)	1kW/CH
SPLIT mode (VC-7524 only)	1MW/CH (MAX)	1kW/CH
PILE mode	512W/CH	8kW/CH (PERSISTENCE)
PEAK DETECT mode (VC-7502/VC-7504 only)	1kw/CH	1kw/CH
ENVELOPE	1kwCH (VC-7502/04) 512w/CH (VC-7524)	1kwCH

## DISPLAY FUNCTION

Refresh mode/Infinity persistence mode  
Waveform clear  
DOT display, linear display, Interpolation display  
X-Y diaplay  
Horizontal Zooming Position  
GND point display  
Trigger level display  
Graticule (Grid, Axes, Frame)

## DISPLAY FUNCTION

Refresh mode/Infinity persistence mode  
Waveform clear  
DOT display, linear display, Interpolation display  
X-Y display  
Horizontal Zooming Position  
GND point display  
Trigger level display  
Graticule (Grid, Axes, Frame)

## PROCESSING FUNCTION

+, -, x, INV, ABS

Two kinds of operations, operation 1 and operation 2, can be carried out simultaneously between any two waveforms out of four input waveforms.

Average mode

Exponential Average  
Weighting Factor: 2 to 256 ( $2^n$ )

## MEASUREMENT FUNCTION

Cursor readout  
Mode  
Item  
Pulse parameter

Between cursors,  $\Delta V$  with Auto cursor.  
 $V(\text{REF}, \Delta, \Delta V)$ ,  $T(\text{REF}, \Delta, \Delta T, 1/\Delta T)$ .

Any 4 parameters out of the following 17 parameters can be measured simultaneously.

Frequency, Period, Rise time/Fall time, Pulse width (positive, negative), Duty cycle, MIN, MAX, Peak-to-Peak, Base, Top, Amplitude, PRE-shoot, Over-shoot, RMS, Average.

Automatic measurement

Auto setup  
GO-NOGO  
Process after judged: GO-NOGO Signal out (open collector), SRQ, HOLD, PRINT OUT or SAVE

## SAVE FUNCTION

Save/Recall Pixel memory

Waveforms on one screen can be saved or and saved data can be recalled (Battery backup).

Waveform memory

IC Memory Card (Option)  
64kbyte IC card: 8kWx6 waveforms  
2Mbyte IC card: 8kWx200 waveforms  
4Mbyte IC card (VC-7524 only) :2MWx1 waveform

Setup memory  
Panel backup (Battery backup)

10 setups  
Setup data at power off is retained.

## INPUT/OUTPUT

Interface  
Panel control

RS-232C, GPIB  
Programmable  
Panel control can be done through RS-232C or GPIB I/F.

Hard copy output

External HP-GL plotter  
Available pen colors: Six colors  
Plot size: A6, A5, A4, A3  
Paper size: A4, A3

**Video signal output**

Interface

Digital RGB

Monitor used

Multiscan color monitor (IBM-PC or Compatible)

Frequency

H:21.8kHz

V:60.06Hz(± 2%)

**Calibration output**

Frequency

1kHz ± 20%

Output voltage

0.5V± 1%

**Internal INPUT/OUTPUT**

Internal Printer

Thermal serial Printer

Paper width

112 mm

Print dot size

512 dots × 328 dots

A hard copy of the data displayed on the screen can be produced.

IC Memory Card Slot

JEIDA standard SRAM IC Card

Max. 4Mbytes Card usable

**TIMER**

Provides operation start time to produce a hard copy by the built-in printer or the external plotter, or to save data to the IC memory card.

**DISPLAY**

Resolution

512 × 328 dot

Type

7 inch raster scan (B/W)

Waveform resolution

501 × 255 dots

Graticule

10 div × 8 div

**OTHERS**

Dimensions

355(W)x170(H)x380(D)mm

Weight

10kg approx.

Power Supply

90V-132V/180V-250V

Power frequency

48-440Hz

Power consumption

110W approx. (VC-7504/24)

90W approx. (VC-7502)

Environmental temperature and humidity

Rated range of use

10-35°C (When auto calibration is performed in the ambient temperature of 25 ± 5°C)

Operation

0-40°C (45-80%)

Storage

-20-60°C (35-85%)

Printer Paper Storage: Less than 30°C( 60%)

# 9.2 Dimensions

(mm)

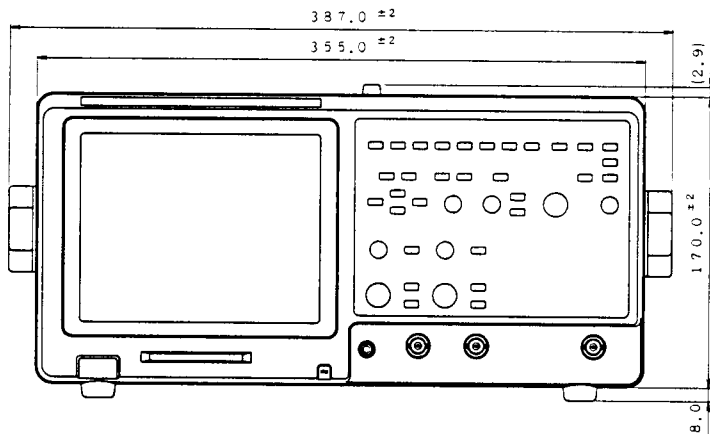
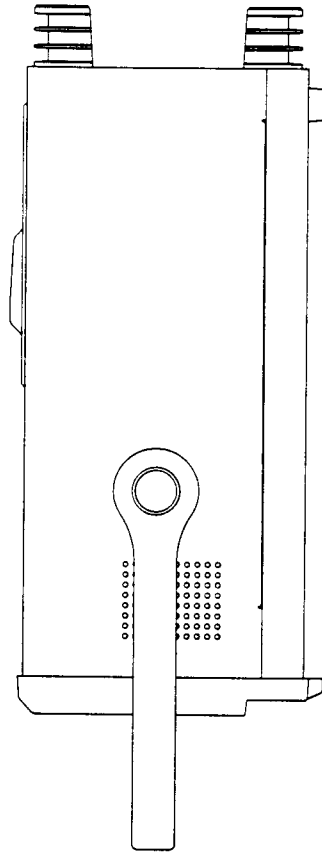
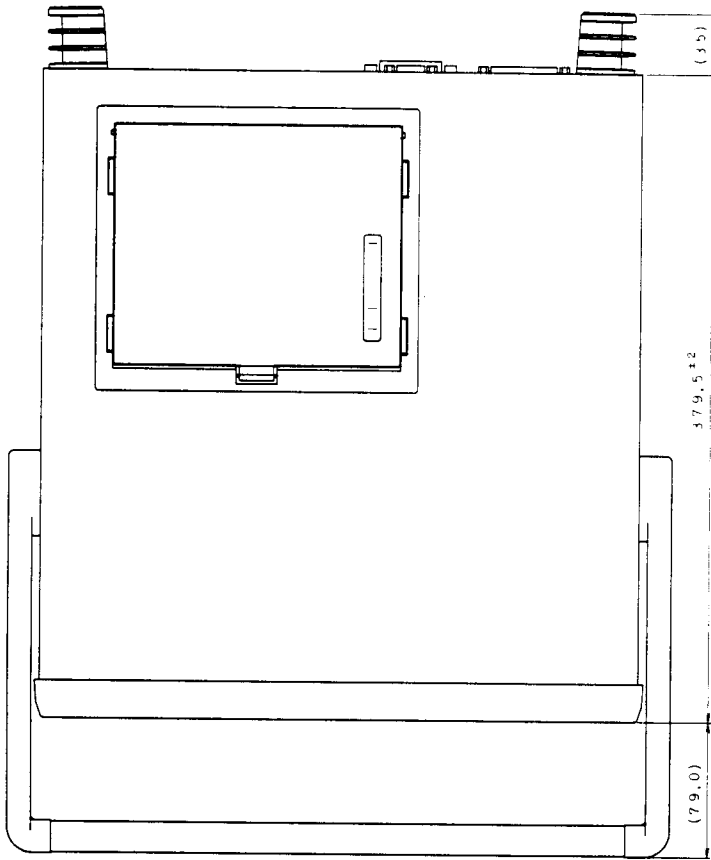



# APPENDIX A CALCULATION EXPRESSION OF PULSE PARAMETER

The pulse parameter measurement function consists of functions measuring 17 kinds of parameter items.

The calculation expression for each parameter is shown below.

## 1. Calculation of Minimum (MIN) and Maximum (MAX)

The minimum value is MIN and the maximum value is MAX in the data of the whole waveform.

## 2. Calculation of Base (BASE) and Top (TOP)

BASE and TOP are calculated by the histogram analysis of the waveform to be measured.

### (1) Base (BASE)

'Center value  $(MAX - MIN)/2$ ' is calculated to obtain the maximum histogram below the center value.

If the frequency of the obtained value is 5% or more, it is taken as BASE. If the frequency of the obtained value is less than 5%, MIN is taken as BASE.

### (2) Top (TOP)

The center value is calculated to obtain the maximum histogram over the center value.

If the frequency of the obtained value is 5% or more, it is taken as TOP. If the frequency of determined value is less than 5%, MAX is taken as TOP.

## 3. Calculation of Peak-to-peak (VP-P) and Amplitude (AMP)

(1) VP-P = MAX - MIN

(2) AMP = TOP - BASE

## 4. Calculation of Preshoot (PRE) and Overshoot (OVER)

### (1) Preshoot (PRE)

If the first edge of pulse rises, PRE = BASE - MIN

If the first edge of pulse falls, PRE = MAX - TOP

### (2) Overshoot (OVER)

If the first edge of pulse rises, OVER = MAX - TOP

If the first edge of pulse falls, OVER = BASE - MIN

## 5. Calculation of Period (PER) and Frequency (FREQ)

### (1) Period (PER)

If the first edge of pulse rises,

Period = Time at 50% point in the second rising edge - Time at 50% point in the first rising edge

If the first edge of pulse falls,

Period = Time at 50% point in the second falling edge - Time at 50% point in the first falling edge

### (2) Frequency (FREQ)

$$FRQ = \frac{1}{PER}$$



## 6. Calculation of Positive-width (+ Wid), Negative-width(-Wid), and Duty-cycle (DUTY)

### (1) Positive-width (+ Wid)

If the first edge of pulse rises,

$$+ \text{Wid} = \text{Time at 50\% point in the first falling edge} - \text{Time at 50\% point in the first rising edge}$$

If the first edge of pulse falls,

$$+ \text{Wid} = \text{Time at 50\% point in the second falling edge} - \text{Time at 50\% point in the first rising edge}$$

### (2) Negative- width (-Wid)

If the first edge of pulse rises,

$$- \text{Wid} = \text{Time at 50\% point in the second rising edge} - \text{Time at 50\% point in the first falling edge}$$

If the first edge of pulse falls,

$$- \text{Wid} = \text{Time at 50\% point in the first rising edge} - \text{Time at 50\% point in the first falling edge}$$

$$(3) \quad \text{Duty} = \frac{+ \text{Wid}}{\text{PRE}} \times 100$$

(Note) The 50% point represents the point where the waveform crosses the half level (50%) between TOP and BASE.

## 7. Calculation of Rise Time (RISE) and Fall Time (FALL)

### (1) Rise - Time (RISE)

$$\text{RISE} = \text{Time at 90\% point in the first rising edge} - \text{Time at 10\% point in the first rising edge}$$

### (2) Fall - Time (FALL)

$$\text{FALL} = \text{Time at 10\% point in the first falling edge} - \text{Time at 90\% point in the first falling edge}$$

## 8. Calculation of RMS (RMS) and Average (AVG)

The root-mean-square value (RMS) and the average value over the first one period of a waveform are calculated.

The period of the waveform represents the period defined in section 5. (1) Period and the n data which are present in this period are calculated by applying the following equations.

$$(1) \quad \text{RMS} = \sqrt{\frac{1}{n} \sum_{j=1}^n V_j^2} \quad 1/2$$

$$(2) \quad \text{AVG} = \frac{1}{n} \sum_{j=1}^n V_j$$

(Note) The 90% point represents the point where the waveform crosses the 90% level from BASE between TOP and BASE.

The 10% point represents the point where the waveform crosses the 10% level from BASE between TOP and BASE.

# APPENDIX B SETTING BY FACTORY

The set values (default values) of measuring conditions including the panel setting set by the factory are retained in the internal memory and the set values can be called anytime as necessary to enable measurement on the setting by the factory.

Table B-1 Shows the default setting by the factory.

**Table B-1 Setting by factory (default values )**

Set Item	Abbreviation	Default value	Set (check) point
Operation system Operation mode Average	RUN,HOLD AVERAGE	RUN status Off	Panel LED Fixed menu
Related to vertical axis  Waveform display Probe factor Vertical axis range Display position Input coupling	  DISPLAY CHi PROBE VOLTS/DIV POSITION COUPLING	(Common to all channels) On x10 1V 0V DC	  Panel LED Memu page 1 Panel readout Panel readout Panel readout
Related to horizontal axis Time base range Delay time	TIME/DIV DELAY	1ms 0s	Panel readout Panel readout
Related to trigger Trigger type Trigger mode Trigger setup Source Coupling Slope Level TV scanning system	TRIGGER AUTO/NORM 1st/2nd SOURCE COUPLING SLOPE LEVEL TV FORM	EDGE trigger AUTO 1st CH1 (both 1st and 2nd) DC (both 1st and 2nd) Rise (both 1st and 2nd) 0V (both 1st and 2nd) 525 lines	Fixed menu Panel LED Panel LED Panel readout Panel readout Panel readout Panel readout Fixed menu
Related to display Acquisition mode Persistence Display scale Dot join Magnification interpolation	MODE PERS GRATICULE DOTJOIN INTERPOL	Normal Refresh Grid Off LIN	Fixed menu Menu page A Menu page A Menu page A Menu page A
Related to save and recall Type of file File number Save memory display  IC memory card capacity IC memory format	FILETYPE FILE NO MEMORY1 MEMORY2 MEMORY3 MEMORY4 IC-CARD FORMAT	Byte data 1 Off Off Off Off 64k bytes END	Menu page 2 Menu page 2 Fixed menu Fixed menu Fixed menu Fixed menu Menu page 2 Menu page 2

**Table B-1 Setting by factory (default values )**

Set Item	Abbreviation	Default value	Set (check) point
Related to measurement and operation Source of measurement Pulse parameter measurement item Operation 1 Operation 2	MEASURE of PARAMETR1 PARAMETR2 PARAMETR3 PARAMETR4 F1 F2	Channel 1 Frequency (FREQ) Minimum value (MIN) Maximum value (MAX) Average value (AVG) Off Off	Fixed menu Measured value display Measured value display Measured value display Measured value display Fixed menu Fixed menu
Related to interface Type GPIB mode GPIB address Delimiter EOI RS-232C baud rate RS-232C stop bit RS-232C parity bit	INTERFACE MODE MY ADDRESS EOI BAUD RATE STOP BIT PARITY	RS-232C TALK ONLY 1 On 4800 baud 1 No default value	Menu page 8 Menu page 8 Menu page 8 Menu page 8 Menu page 8 Menu page 8 Menu page 8
Related to hard copy Copy device Selected portion Plot size Plot position Pen replacement	HARDCOPY PLOT SIZE POSITION PEN CHANGE	Printer ALL A4 on A4 Auto On	Fixed menu Menu page 5 Menu page 5 Menu page 5 Menu page 5
GO-NOGO judgment function GO-NOGO judgment Judging condition Process Edit of boundary Source for making area Execution of edit	GO-NOGO WHEN REACTION EDIT SOURCE EDITING	Off A PART of ANY is OUT No default value BOUNDARY Channel 1 END	Menu page 6 Menu page 6 Menu page 6 Menu page 7 Menu page 7 Menu page 7
Automatic calibration Calibration range Intermittent calibration Execution of calibration	CALIBRATE AUTO VPOSI CAL EXEC	FULL Off END	Menu page 9 Menu page 9 Menu page 9
Related to setup Setting of default	DEFAULT	OFF	Menu page 9
Display function	H MODE ZOOM SELECT CLEAR FINE/COARSE	A SINGLE ZOOM1 CURRENT FINE	Panel readout Menu page B Menu page B Menu page B Panel readout
Long memory function (VC-7524 only)	SEARCH LENGTH SEGMENTS	MAX 1M 2	Menu page B Menu page C Menu page C